

ÍNDICE GERAL

Páginas 06 à 15	Páginas 18 à 20	Páginas 24 à 41	Páginas 45 à 76	Páginas 77 à 102	Páginas 103 à 112	Páginas 114 à 121	Páginas 123 à 128	Páginas 139 à 135	Páginas 136 à 148	Páginas 149 à 184
ADESIVOS E QUÍMICOS	IMPERMEABILIZANTES	AGROPECUÁRIA	ELÉTRICA	HIDRÁULICA	ULTRA METAIS	FERRAGENS	AUTOMOTIVO	FIXADORES	PINTURA	FERRAMENTAS E UTILIDADES

ABRAÇADEIRA BORBOLETA	114 à 121	BICO PARA TORNEIRA	25 à 41	CHAVE FENDA ELETRICA	149 à 178	CUNHA PARA NIVELAMENTO	149 à 178
ABRAÇADEIRA PARA LÂMPADA TUBULAR	114 à 121	BLOCO ESPUMA	149 à 178	CHAVE FIXA	149 à 178	CUPINICIDA	25 à 41
ABRAÇADEIRAS NYLON	149 à 178	BOBINA CABO	45 à 75	CHAVE HIDRAULICA MULTIFUNCIONAL	149 à 178	CURVA 45 ESGOTO	77 à 101
ABRAÇADEIRAS ZINCADAS	114 à 121	BOINA PARA POLIMENTO	124 à 127	CHAVE INGLESIA	149 à 178	CURVA 45 SOLDÁVEL	77 à 101
ACABAMENTO MONO. P/ CHUVEIRO	77 à 101	BOMBA DE AR MANUAL	149 à 178	CHAVE MULTIFUNCIONAL	149 à 178	CURVA 90 SOLDÁVEL	77 à 101
ACABAMENTO PARA REGISTRO	77 à 101	BOMBA SUBMERSA	149 à 178	CHAVE PARA MANDRIL	149 à 178	CURVA DE RETORNO GALVANIZADO	77 à 101
ACABAMENTO VÁLVULA DESCARGA	77 à 101	BOTA	25 à 41	CHAVE PHILIPS	149 à 178	CURVA GALVANIZADO	77 à 101
ACOPLAMENTO INDUSTRIAL	45 à 75	BOTÃO ACIONADOR CX ACOPLADA	77 à 101	CHAVE SOQUETE	149 à 178	CURVA LONGA ESGOTO	77 à 101
ADAPTADOR CAIXA D'ÁGUA	77 à 101	BOTINA	25 à 41	CHAVE SOQUETE	149 à 178	CURVA MACHO E FEMEA GALVANIZADO	77 à 101
ADAPTADOR CX'ÁGUA GALVANIZADO	77 à 101	BROCAS	149 à 178	CHAVE TESTE	45 à 75	CURVA TRANSPOSIÇÃO SOLDÁVEL	77 à 101
ADAPTADOR INTEIRO	77 à 101	BUCHA	130 à 134	CILINDRO	149 à 178	DESCARBONIZANTE	124 à 127
ADAPTADOR PARA MANGUEIRA	25 à 41	BUCHA REDUÇÃO	77 à 101	CINTA E CATRACA	25 à 41	DESEMPENADEIRA	149 à 178
ADAPTADOR SOLDÁVEL	25 à 41	BUJAO GALVANIZADO	77 à 101	CLAREADOR DE MADEIRA	138 à 145	DESENGRAXANTE	124 à 127
ADAPTADOR T TANQUE E MAQUINA	25 à 41	CABEÇOTE TORRE CX ACOPLADA	77 à 101	CLARIFICANTE	25 à 41	DESENGRIPANTE	06 à 16
ADESIVO ANTI IMPACTO	06 à 16	CABIDE PAREDE	149 à 178	CLORADOR	25 à 41	DESENTUPIDOR DE TUBULAÇÃO	77 à 101
ADESIVO ESTRUTURAL	06 à 16	CABO COAXIAL	45 à 75	CLORO 3 EM 1	25 à 41	DETERGENTE AUTOMOTIVO	124 à 127
ADESIVO INSTANTÂNEO	06 à 16	CABO DE BATERIA	125 à 128	CLORO TABLETE	25 à 41	DISCO BORRACHA	149 à 178
ADESIVO MOVELEIRO	06 à 16	CABO FLEXIVEL	47 à 76	COLA BRANCA	06 à 16	DISCO DESBASTE	149 à 178
ADESIVO P/ JUNTAS DE MOTORES	124 à 127	CABO PARA ENXADA	25 à 41	COLA CONTATO	06 à 16	DISCO DIAMANTADO	149 à 178
ADESIVO PU 40	06 à 16	CABO PARA PICARETA	25 à 41	COLA EPÓXI	06 à 16	DISCO FLAP	149 à 178
ADESIVO TRAVA PARAFUSO	06 à 16	CABO REDE/ALARME/CFTV	45 à 41	COLA MADEIRA	06 à 16	DISCO INOX	149 à 178
ADESIVO VEDANTE P/ ESCAPAMENTO	06 à 16	CADEADOS	149 à 178	COLA RATO	25 à 41	DISCO LIXA	149 à 178
ADITIVO COLANTE	19 à 21	CAIXA ACOPLADA CERAMICA	77 à 101	COLA REVESTIMENTO	06 à 16	DISCO REBOLO	149 à 178
ADITIVO IMPERMEABILIZANTE	19 à 21	CAIXA COLETORA ÁGUA PLUVIAL	77 à 101	COLA SPRAY	06 à 16	DISCO SERRA	149 à 178
ADITIVO PARA RADIADOR	124 à 127	CAIXA DE ATERRAMENTO	45 à 75	COLA TACO	06 à 16	DISCO TUNGSTÊNIO	149 à 178
AGICIDA DE MANUTENÇÃO	25 à 41	CAIXA DE CORREIO	149 à 178	COLA TUBO	06 à 16	DISJUNTOR	45 à 75
AGUARAZ	138 à 145	CAIXA DE DESCARGA	77 à 101	COLA TUDO MULTIUSO	06 à 16	DISJUNTOR ENERGIA SOLAR	45 à 75
ALAVANCA AÇO	149 à 178	CAIXA DE FERRAMENTAS	149 à 178	COLETE REFLETIVO	149 à 178	DOBRAÇA PORTEIRA	25 à 41
ALGICIDA DE CHOQUE	25 à 41	CAIXA DE GORDURA	77 à 101	COLHEDOR DE FRUTAS	25 à 41	DOBRADIÇAS	114 à 121
ALGICIDA DE METAIS	25 à 41	CAIXA DE POLIETILENO	77 à 101	COLHER PEDREIRO	149 à 178	DUCHA ELÉTRICA	77 à 101
ALICATE AMPERIMETRO	149 à 178	CAIXA EMBUTIR	45 à 75	CONECTOR COM BUCHA DE REDUÇÃO	77 à 101	DUCHA FRIA	77 à 101
ALICATE BICO	149 à 178	CAIXA FUNDO MÓVEL	45 à 75	CONECTOR DE DERIVAÇÃO	45 à 75	DUCHA HIGIÊNICA	77 à 101
ALICATE BOMBA D'ÁGUA	149 à 178	CAIXA PARA MASSA	149 à 178	CONECTOR DE EMENDA	45 à 75	ELETRODO	124 à 127
ALICATE CORTE	149 à 178	CAIXA PASSAGEM	47 à 76	CONECTOR DE PORCELANA	45 à 75	ELETRODUTO FLEXIVEL	45 à 75
ALICATE CORTE DIAGONAL	149 à 178	CAIXA PROTEÇÃO	47 à 76	CONECTOR METÁLICO	45 à 75	ELETRODUTO PVC RIGIDO	45 à 75
ALICATE P/ DESCASCAR FLOS E CABOS	149 à 178	CAIXA SIFONADA	77 à 101	CONJUNTO 2 INT + TOMADA	45 à 75	EMENADA PARA MANGUEIRA	25 à 41
ALICATE PARA NIVELAMENTO	149 à 178	CAIXA SOBREPOR	45 à 75	CONJUNTO 2 INTERRUPTORES	45 à 75	EMENDA COAXIAL	45 à 75
ALICATE PRESSÃO	149 à 178	CAIXA SOBREPOR DISJUNTOR	45 à 75	CONJUNTO 2 TOMADA 2P+T	45 à 75	EMENDA MANGUEIRA	25 à 41
ALICATE REBITADOR	149 à 178	CAIXA TÉRMICA	149 à 178	CONJUNTO 3 INTERRUPTORES	45 à 75	ENGATE FLEXIVEL	25 à 41
ALICATE UNIVERSAL	149 à 178	CAIXINHA DE LUZ	45 à 75	CONJUNTO 4 CHAVES	45 à 75	ENGATE RÁPIDO	25 à 41
ANCINHO	25 à 41	CALHA PISO	77 à 101	CONJUNTO CONECTOR ANTENA	45 à 75	ENXADA	25 à 41
ANEL DE VEDAÇÃO VASO SANITARIO	77 à 101	CÂMARA DE AR PARA CARRINHO	114 à 121	CONJUNTO DE PINTURA	138 à 145	ENXADÃO	25 à 41
ANEL VEDACAO ESGOTO	77 à 101	CAMPAINHA	45 à 75	CONJUNTO INT SIMPLES	45 à 75	ESCADAS	149 à 178
ANTENA DIGITAL INTERNA	149 à 178	CANALETA	149 à 178	CONJUNTO P/ JARDINAGEM	25 à 41	ESCÁPULA COM ROSCA	114 à 121
APLICADOR DE SILICONE	149 à 178	CANO PARA DUCHA/CHUVEIRO	77 à 101	CONJUNTO RJ 45	46 à 75	ESCOVA CIRCULAR	149 à 178
ARAMES	25 à 41	CANTONEIRA SEXTAVADA	149 à 178	CONJUNTO TELEFONE	46 à 75	ESCOVA DE AÇO	149 à 178
ARCO DE SERRA	149 à 178	CAP ESGOTO	77 à 101	CONJUNTO TOMADA 2P+T	46 à 75	ESCOVA MULTIUSO	149 à 178
ARGAMASSA POLIMÉRICA	19 à 21	CAP SOLDÁVEL	77 à 101	CONTRA SEDE PARA VÁLVULA	77 à 101	ESGUICHOS	25 à 41
ARGOLA PARA SELARIA	25 à 41	CAPA DE CHUVA	149 à 178	CONTROLE PARA VENTILADOR	45 à 75	ESMALTE SINTETICO	138 à 145
ARMARIO PARA BANHEIRO	77 à 101	CAPO P/ PÁ, PICARETA E MACHADO	25 à 41	CONJUNTO PINTURA	138 à 145	ESMERILHADEIRA	149 à 178
ARRUELA	115 à 122	CARRINHO DE MÃO	114 à 121	CONVERSOR PARA REGISTRO	77 à 101	ESPACADOR JUNTA PISO	149 à 178
ASFALTO LÍQUIDO	19 à 21	CATALISADOR MASSA PLASTICA	124 à 127	CONVERTEDOR FERRUGEM	06 à 16	ESPACADOR PARA NIVELAMENTO	149 à 178
ASPIRADOR PARA PISCINA	25 à 41	CAVADEIRA ARTICULADA	25 à 41	COPO DE FILTRO COM VELA	77 à 101	ESPATULAS	149 à 178
ASSENTO SANITÁRIO	77 à 101	CAVADEIRA RETA	25 à 41	CORANTE EM PÓ	138 à 145	ESPONJA MÁGICA	149 à 178
ASTE ATERRAMENTO	45 à 75	CAVADEIRA TRADO	25 à 41	CORANTE LIQUIDO	138 à 145	ESPONJA MULTIUSO	149 à 178
BACIA SANITARIA	77 à 101	CENTRO DISTRIBUIÇÃO	45 à 75	CORDAS	25 à 41	ESPUMA EXPANSIVA	06 à 16
BALANÇA BANHEIRO	149 à 178	CERA AUTOMOTIVA	124 à 127	CORPO CAIXA SIFONADA	77 à 101	ESQUADRO	149 à 178
BALANÇA COZINHA	149 à 178	CESTO PARA PIA	77 à 101	CORRENTE	149 à 178	ESTABILIZANTE PH	25 à 41
BALDE	149 à 178	CHAPISCO	19 à 21	CORRENTE CAIXA ACOPLADA	77 à 101	ESTICADOR PARA ARCO DE SERRA	149 à 178
BANDEJA PARA PINTURA	138 à 145	CHAVE AJUSTÁVEL	149 à 178	CORRENTE PLASTICA	149 à 178	ESTILETE	149 à 178
BARRA DE APOIO	149 à 178	CHAVE BIELA	149 à 178	CORTADOR DE PISO	149 à 178	ESTOJO DE ANÁLISE	25 à 41
BARRA ROSCADA	130 à 134	CHAVE BOIA	149 à 178	CORTINA PARA BOX	149 à 178	ESTOPA ALVEJADA	124 à 127
BARRILHA	25 à 41	CHAVE CATRACA	149 à 178	COTOVELO 45 GALVANIZADO	77 à 101	ESTOPA PARA POLIMENTO	124 à 127
BASE MISTURADOR	77 à 101	CHAVE COMBINADA	149 à 178	COTOVELO 90 GALVANIZADO	77 à 101	EXTENSÃO CROMADA	78 à 102
BASE REGISTRO PRESSÃO	77 à 101	CHAVE DE BOCA	149 à 178	CRISTALIZADOR DE VIDROS	124 à 127	EXTENSÃO ELÉTRICA	45 à 75
BASE VÁLVULA DESCARGA	77 à 101	CHAVE DE GRIFO	149 à 178	CRUZETA GALVANIZADO	149 à 178	EXTENSOR PARA TORNEIRA	77 à 101
BETUME	138 à 145	CHAVE DE VIRAR FERRO	149 à 178	CUBA	77 à 101	FAÇÃO	25 à 41
BICO DE ESGUICHO P/ MANGUEIRA	25 à 41	CHAVE FENDA	149 à 178	CUMEEIRA	149 à 178	FECHADURAS	114 à 121

ÍNDICE GERAL

FERRO DE SOLDAR	124 à 127	MAÇARICO	149 à 178	RALO CLICK	77 à 101	TESOURA	149 à 178
FERROLHO	114 à 121	MACHADINHA	149 à 178	RALO INVISIVEL	77 à 101	TESOURA CORTA VERGALHÃO	149 à 178
FILTRO DE LINHA	45 à 75	MACHADO	25 à 41	RALO LINEAR	77 à 101	TESOURA GRAMA	25 à 41
FILTRO PARA CAIXA D 'ÁGUA	78 à 101	MANGUEIRA CHUVEIRO	25 à 41	RALO REDONDO	77 à 101	TESOURA PODA	25 à 41
FIO NYLON PARA ROÇADEIRA	25 à 41	MANGUEIRA ENTRADA MAQ. LAVAR	25 à 41	RALO SECO	77 à 101	TESTE DE VOLTAGEM	45 à 75
FITA ANTIDERRAPANTE	06 à 16	MANGUEIRAS ÁGUA	25 à 41	RALO SIFONADO	77 à 101	TUJOLO DE VIDRO	149 à 178
FITA AUTO FUSÃO	06 à 16	MANGUEIRAS GÁS	25 à 41	REAGENTE DE CLORO	25 à 41	TIMER ANALOGICO	46 à 75
FITA CREPE	06 à 16	MANGUEIRAS MAQUINA/TANQUINHO	25 à 41	REAGENTE PH	25 à 41	TIMER DIGITAL	46 à 75
FITA DEMARCAÇÃO	06 à 16	MANTA FITA	06 à 16	REBITE	130 à 134	TINGIDOR	138 à 145
FITA DUPLA FACE	06 à 16	MANTA LIQUIDA	06 à 16	RECEPTACULOS	114 à 121	TINTA EMBORRACHADA	138 à 145
FITA EMBALAGEM	06 à 16	MANTA POLIETILENO	06 à 16	REDUÇÃO EXCENTRICA ESGOTO	77 à 101	TINTA LÁTEX	138 à 145
FITA ISOLANTE	45 à 75	MANTA TÉRMICA	06 à 16	REFIL ELEMENTO FILTRANTE	77 à 101	TINTA PISO	138 à 145
FITA LED	45 à 75	MANUGEIRAS NÍVEL	149 à 178	REFLETOR LED	45 à 75	TOMADA EM BARRAS	45 à 75
FITA METRICA	149 à 178	MARRETA	149 à 178	REGADOR	25 à 41	TOMADA EXTERNA	45 à 75
FITA SILVER TAPE	06 à 16	MARTELO	149 à 178	REGISTRO DUPLO BINÓCULO	77 à 101	TOMADA POLARIZADA	45 à 75
FITA SINALIZAÇÃO	06 à 16	MÁSCARAS	149 à 178	REGISTRO ESFERA	77 à 101	TOMADA SOBREPOR INDUSTRIAL	45 à 75
FITA TESTE PARA PISCINA	25 à 41	MASSA CALAFETAR	138 à 145	REGISTRO ESFERA	77 à 101	TOPMADA PARA RELE	45 à 75
FITA VEDA ROSCA	77 à 101	MASSA EPÓXI	138 à 145	REGISTRO GÁS	149 à 178	TORNEIRA BEBEDOURO	77 à 101
FIXA CUBA	06 à 16	MASSA PARA MADEIRA	138 à 145	REGISTRO GAVETA	77 à 101	TORNEIRA BÓIA	77 à 101
FIXA ESPELHO	06 à 16	MASSA PLASTICA	124 à 127	REGISTRO PARA FILTRO	77 à 101	TORNEIRAS	77 à 101
FOGAREIRO PORTATIL	149 à 178	MECANISMO CAIXA ACOPLADA	78 à 100	REGUA DE PEDREIRO	149 à 178	TORNO Morsa DE BANCADA	149 à 178
FOICE	25 à 41	METRO	149 à 178	REGULADOR DE GÁS	149 à 178	TORQUÉS	149 à 178
FONTE COLMEIA SLIM	45 à 75	MIOLO TOMADA	45 à 75	REJUNTE	19 à 21	TORRADOR DE CAFÉ	25 à 41
FORMÃO	25 à 41	MISTURADOR MONOCOMANDO	77 à 101	RELE FOTOCÉLULA	45 à 75	TRANCA FERROLHO	114 à 121
FRISO VEDANTE PARA PORTA	25 à 41	MISTURADOR TINTAS/ARGAMASSAS	138 à 145	RELE FOTOELÉTRÔNICO	45 à 75	TRANCA PORTEIRA	25 à 41
FUNDO PREPARADOR	138 à 145	MÓDULO 2P+T	45 à 75	REMOVEDOR FERRUGEM	06 à 16	TRANSFORMADOR	45 à 75
FURADEIRA	149 à 178	MÓDULO ANTENA	45 à 75	REMOVEDOR PASTOSO	138 à 145	TRAVA PARAFUSO	06 à 16
GANCHO PARA REDE	114 à 121	MÓDULO CAIXA SOBREPOR	45 à 75	REMOVEDOR DE TINTAS	138 à 145	TREINA FITA MÉTRICA	149 à 178
GANCHO /PITÃO	114 à 121	MÓDULO CAMPAINHA	45 à 75	REPARO PARA VÁLVULA	77 à 101	TRENA	149 à 178
GARFO PARA ROLO	138 à 145	MÓDULO COM FURO	45 à 75	REPARO UNIVERSAL PARA TORNEIRA	77 à 101	TRINCHA	138 à 145
GARRA JACARÉ	27 à 43	MÓDULO DE REDUÇÃO	45 à 75	RESISTÊNCIAS	45 à 75	TUBO DESCIDA CAIXA DESCARGA	77 à 101
GARRAFÃO TÉRMICO	150 à 179	MÓDULO INTERRUPTOR	45 à 75	RETENTOR	77 à 101	TUBO ESGOTO	77 à 101
GESSO RÁPIDO	150 à 179	MÓDULO RJ 45	45 à 75	REVESTIMENTO IMPERMEAVEL	149 à 178	TUBO LIGAÇÃO SANFONADO	77 à 101
GRAFITE SPRAY	125 à 128	MÓDULO TOMADA PARA TELEFONE	45 à 75	RODA PARA CARRINHO	114 à 121	TUBO PARA VÁLVULA DESCARGA	77 à 101
GRAFITE SPRAY SECO	125 à 128	MÓDULO USB	45 à 75	RODEL	149 à 178	TUBO SOLDÁVEL	77 à 101
GRAMPEADOR	150 à 179	MÓDULO VISOR CEGO	45 à 75	RODIZIO GIRATORIO	114 à 121	TUDO LIGAÇÃO AJUSTÁVEL	77 à 101
GRAMPO ATERRAMENTO	47 à 76	MOSQUETÃO	114 à 121	RODO CURRAL	25 à 41	ULTRA COMPLEMENTOS	06 à 16
GRAMPOS	150 à 179	MULTIMETRO	45 à 75	RODO TERREIRO	25 à 41	UNIÃO INTERNO	77 à 101
GRAXA	07 à 17	MULTIMETRO DIGITAL	45 à 75	ROLDANA	45 à 75	UNIÃO PARA MANGUEIRA	77 à 101
GRELHA	78 à 102	MVS REGISTRO	77 à 101	ROLO DE PINTURA	138 à 145	UNIÃO SOLDÁVEL	77 à 101
INTERRUPTORES	47 à 76	MVS TORNEIRA	77 à 101	ROLOS	138 à 145	VÁLVULA ALTERNADORA DE PRESSÃO	77 à 101
IRRIGADOR GIRATÓRIO	27 à 43	NÍPEL ROSCÁVEL	77 à 101	SABONETEIRA	77 à 101	VÁLVULA CLICK	77 à 101
ISOLADOR DE PORCELANA	45 à 75	NIPLE DUPLO GALVANIZADO	77 à 101	SEDE PARA VÁLVULA	25 à 41	VÁLVULA DE RETENÇÃO ESGOTO	77 à 101
ISOLADOR PIMENTÃO OLHAL	45 à 75	NÍVEL	149 à 178	SELA TRINCAS	77 à 101	VÁLVULA DE SUÇÃO	77 à 101
ISOLADRO ROLDANA	45 à 75	OBTURADOR CAIXA ACOPLADA	77 à 101	SENSOR PRESENÇA	06 à 16	VÁLVULA MICTORIO	77 à 101
JOELHO 90	77 à 101	ÓCULOS PROTETOR	149 à 178	SERRA CIRCULAR	45 à 75	VÁLVULA REDUTORA DE PRESSÃO	77 à 101
JOELHO INTERNO	77 à 101	OLEO DE LINHAÇA	149 à 178	SERRA COPO	149 à 178	VÁLVULA RETENÇÃO	77 à 101
JOGO CHAVE ALLEN	149 à 178	ÓLEO LUBRIFICANTE	06 à 16	SERRA MANUAL	149 à 178	VÁLVULAS	77 à 101
JOGO CHAVE CANHÃO	149 à 178	PÁ	25 à 41	SERRA MÁRMORE	149 à 178	VARAL	149 à 178
JOGO CHAVE FENDA/PHILIPS	149 à 178	PAD PARA RECORTE	138 à 145	SERRA TICO TICO	149 à 178	VASELINA	06 à 16
JOGO CHAVE TORX	149 à 178	PALHA DE AÇO	124 à 127	SERROTE	149 à 178	VASSOURA GARI	25 à 41
JOGO DE FERRAMENTAS	149 à 178	PAPELEIRA	77 à 101	SIFÕES	77 à 101	VASSOURA METALICA	25 à 41
JOLEHO 45 SOLDÁVEL	77 à 101	PARAFUSADEIRA/FURADEIRA	149 à 178	SILICONE	06 à 16	VEDA CALHA	06 à 16
JOLEHO 90 ESGOTO	77 à 101	PARAFUSO ASSENTO SANITÁRIO	130 à 134	SISTEMA X	45 à 75	VEDAÇÃO CAIXA ACOPLADA	77 à 101
JUNÇÃO ESGOTO	77 à 101	PARAFUSO VASO SANITÁRIO	130 à 134	SOLVENTES	138 à 145	VEDANTE AÇO	77 à 101
JUNÇÃO Y PARA FILTRO	77 à 101	PARAFUSOS	150 à 179	SOPRADOR E ASPIRADOR	149 à 178	VEDANTE COM PINO	77 à 101
KIT ACIONADOR PARA VÁLVULA	77 à 101	PASSA FIO	45 à 75	SOQUETE LÂMPADA TUBULAR	45 à 75	VELA PARA FILTRO	77 à 101
KIT CONVERSOR PARA HYDRA	77 à 101	PASSARINHEIRA	149 à 178	SOQUETES	45 à 75	VENTILADOR	149 à 178
KIT FÁCIL PARA REGISTRO	77 à 101	PEDRA DE AFIAR	149 à 178	SPOTS	45 à 75	VENTOSA VIDROS E PORCELANATOS	149 à 178
KIT FÁCIL PARA TORNEIRA	77 à 101	PENEIRAS	25 à 41	SPRAY ANTITRESPINGO P/ SOLDA	114 à 121	VERNIZ	138 à 145
KIT FIXAÇÃO /VEDAÇÃO TELHA	114 à 121	PIA	77 à 101	SPRAY EMBORRACHAMENTO	06 à 16	ZARCÃO	138 à 145
KIT PARA BANHEIRO	77 à 101	PICARETA	25 à 41	SPRAY GRAFITE SECO	138 à 145		
KIT PARAFUSOS FIXAÇÃO CX ACOPLADA	130 à 134	PINCEL	137 à 145	SPRAY GRAXA BRANCA	138 à 145		
KIT PONTAS BITS	149 à 178	PINO ENGATE RÁPIDO	25 à 41	SPRAY USO GERAL	06 à 16		
KIT PONTEIRA	149 à 178	PINO FÊMEA 2P	45 à 75	SPUD SANFONADO	77 à 101		
KIT SALVA REGISTRO	77 à 101	PINO MACHO	45 à 75	SULFATO DE ALUMÍNIO	25 à 41		
LÂMINA PARA ESTILETE	149 à 178	PINO POLARIZADO DE PORCELANA	45 à 75	SUPORTE CORTINA	114 à 121		
LÂMINA PARA ROÇADEIRA	25 à 41	PISTOLA DE AR	138 à 145	SUPORTE MICROONDAS	114 à 121		
LÂMPADA BOLINHA	45 à 75	PISTOLA PULVERIZAÇÃO /LIMPEZA	25 à 41	SUPORTE PARA DISCO DE LIXA	114 à 121		
LÂMPADA GELEIDEIRA	45 à 75	PLACA CEGA REDONDA	45 à 75	SUPORTE PARA LAJE	46 à 75		
LÂMPADA HALOGENA	45 à 75	PLACAS 2X2	45 à 75	SUPORTE PARA LIXA	149 à 178		
LÂMPADA LED	45 à 75	PLACAS 4X2	45 à 75	SUPORTE PARA MANGUEIRA	25 à 41		
LANTERNA TÁTICA	45 à 75	PLACAS 4X4	45 à 75	SUPORTE PIA	114 à 121		
LÁPIS CARPINTEIRO	149 à 178	PLAFONS	45 à 75	SUPORTE PRATELEIRA	114 à 121		
LATERNA	45 à 75	PLUG INDUSTRIAL	45 à 75	SUPORTE TRIANGULAR	114 à 121		
LAVATORIO	77 à 101	PLUG ROSCÁVEL	45 à 75	SUPORTE TV	114 à 121		
LED DRIVER	77 à 101	PNEU PARA CARRINHO	114 à 121	TALHADEIRA	25 à 41		
LETRAS E NÚMEROS RESIDENCIAL	149 à 178	PONTEIRO	149 à 178	TAMPA CAIXA DE GORDURA	77 à 101		
LIMA	149 à 178	PORCA SEXTAVADA	130 à 134	TAMPA CAIXA GORDURA	77 à 101		
LIMA ENXADA	149 à 178	PORTA ELETRODO	124 à 127	TAMPA CAIXA PASSAGEM	77 à 101		
LIMPA AR CONDICIONADO	06 à 16	PORTA GRELHA	77 à 101	TAMPA DE CAIXA D 'ÁGUA	77 à 101		
LIMPA BORDA	25 à 41	PORTA SABONETE LIQUIDO	77 à 101	TAMPA PARA LAVATORIO	77 à 101		
LIMPA CONTATO	124 à 127	PORTA SANFONADA	149 à 178	TANQUE	77 à 101		
LIMPA PEDRA/PORCELANATO	25 à 41	PORTA SHAMPOO	77 à 101	TANQUE DE POLIETILENO	77 à 101		
LINHA DE PEDREIRO	149 à 178	PORTA TOALHA	77 à 101	TAPETE DE BANHO	77 à 101		
LUXAS	149 à 178	PORTEIRO ELÉTRÔNICO	45 à 75	TARJETA	77 à 101		
LONAS	25 à 41	PREGOS	130 à 134	TE 90	77 à 101		
LUMINAR LED	45 à 75	PRIMER ASFÁLTICO	19 à 21	TE AZUL SOLDÁVEL	77 à 101		
LUMINARIA EMERGENCIA	45 à 75	PROLONGADOR CAIXA GORDURA	77 à 101	TE GALVANIZADO	77 à 101		
LUMINÁRIAS TARTARUGA	45 à 75	PROLONGADOR CAIXA SIFONADA	77 à 101	TE SOLDA E ROSCA	77 à 101		
LUVA 45 ESGOTO	77 à 101	PROLONGADOR CX PASSAGEM/GORDURA	77 à 101	TEE INTERNO	77 à 101		
LUVA AZUL SOLDÁVEL	77 à 101	PROLONGADOR DE AÇO	77 à 101	TELA GALVANIZADA	25 à 41		
LUVA DE CORRER	77 à 101	PROLONGADOR PARA CAVADEIRA	25 à 41	TELA MINI ESTRUTURANTE	25 à 41		
LUVA DE PRESSAO	77 à 101	PROLONGADOR PARA REGISTRO	77 à 101	TELA MOSQUETEIRO	25 à 41		
LUVA DE PROTEÇÃO	149 à 178	PROTETOR ADESIVO	06 à 16	TELA POLIESTER	25 à 41		
LUVA GALVANIZADO	77 à 101	PROTETOR AURICULAR	149 à 178	TELHAS	149 à 178		
LUVA MACHO E FEMEA GALVANIZADO	77 à 101	PRUMO	149 à 178	TERMINAL DE COMPRESSÃO	46 à 75		
LUVA REDUÇÃO	77 à 101	PULVERIZADOR	25 à 41	TERMINAL PRESSAO	46 à 75		
LUVA SOLDA E ROSCA	77 à 101	PUXADOR	114 à 121	TERMINAL TUBULAR	46 à 75		
LUVA SOLDÁVEL	77 à 101	RALINHO CHINES	77 à 101				

ADESIVOS E QUÍMICOS

ULTRA
ATACADISTA

ULTRA
SELANTES

Solucionando os
problemas do
dia a dia!



**ALTAMENTE
EFICIENTE E
VERSÁTIL**

**ADESIVO PU 40
360G**

7270 | **PRETO**
7294 | **CINZA**
7295 | **BRANCO**

**EXCELENTE
RESISTÊNCIA A
INTEMPÉRIES E ALTA
FLEXIBILIDADE**

**SILICONE 250ML
USO GERAL
7297 | INCOLOR**



**TEK
BOND**

SAINT-GOBAIN

A GENTE COLA COM VOCE

Imagens meramente ilustrativas



Descubra as soluções que a Tekbond oferece em:
TEKBOND.COM.BR    [TEKBONDoficial](https://www.youtube.com/TEKBONDoficial)

SAINT-GOBAIN

ADESIVOS E QUÍMICOS



CÓD. DESCRIÇÃO
7235 ADESIVO INST 200 20G BICO ANTIENTUPIAMENTO



CÓD. DESCRIÇÃO
7236 ADESIVO INST 725 TEKBOND 20G BICO FINO



CÓD. DESCRIÇÃO
5310 ADESIVO INST CIANO 793 TEKBOND 100G



CÓD. DESCRIÇÃO
1116 ADESIVO INSTANTÂNEO 793 CIANO 20G



CÓD. DESCRIÇÃO
1117 ADESIVO INST 2G SUPER COLA BLISTER



CÓD. DESCRIÇÃO
5526 COLA TUDO MULTIUSO 20G BLISTER TEKBOND



CÓD. DESCRIÇÃO
5535 ADESIVO MOVELEIRO 20G INST.



CÓD. DESCRIÇÃO
7728 ADESIVO INSTANTÂNEO COLA GEL 20G

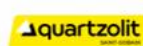

CÓD. DESCRIÇÃO
8328 ADESIVO INSTANTÂNEO CIANO 20G



CÓD. DESCRIÇÃO
6800 ADESIVO INST CIANO ALMASUPER 20G
7716 ADESIVO INST CIANO ALMASUPER 100G



CÓD. DESCRIÇÃO
8787 COLA INSTANTÂNEA SUPER BOND 3G



CÓD. DESCRIÇÃO
4897 COLA CONTATO 200 G TEKBOND
5522 COLA CONTATO 400G TEKBOND



CÓD. DESCRIÇÃO
4898 COLA CONTATO 750 G TEKBOND



CÓD. DESCRIÇÃO
5521 COLA CONTATO 2,8 KG TEKBOND

ADESIVOS E QUÍMICOS



CÓD. DESCRIÇÃO
5604 COLA CONTATO 30 G BLISTER TEK BOND



CÓD. DESCRIÇÃO
8495 COLA CONTATO 75G



CÓD. DESCRIÇÃO
8494 COLA CONTATO 2.7KG



CÓD. DESCRIÇÃO
8493 COLA CONTATO 700G



CÓD. DESCRIÇÃO
8492 COLA CONTATO 200G



CÓD. DESCRIÇÃO
5529 FIX CUBA BLISTER 85G



CÓD. DESCRIÇÃO
5750 COLA TUBO PVC 17G
5751 COLA TUBO PVC 75G
6988 COLA TUBO PVC 175G
6989 COLA TUBO PVC 850G



CÓD. DESCRIÇÃO
6744 COLA TUBO PVC 17G
67456746 COLA TUBO PVC 75G
67467293 COLA TUBO PVC 175G
7293 COLA TUBO PVC 850G



CÓD. DESCRIÇÃO
6895 COLA TUBO CPVC 175G AGUA QUENTE



CÓD. DESCRIÇÃO
8314 COLA TUBO PVC SPRAY ÁGUA FRIA 250ML



CÓD. DESCRIÇÃO
8315 COLA TUBO CPVC SPRAY ÁGUA QUENTE 250ML



CÓD. DESCRIÇÃO
5534 ADESIVO TRAVA PARAFUSOS 120 10G



CÓD. DESCRIÇÃO
5701 ADESIVO TRAVA PARAFUSO ORBIFIX 10 VERMELHO



CÓD. DESCRIÇÃO
3984 COLA BRANCA EXTRA 500G
3985 COLA BRANCA EXTRA 1KG



CÓD. DESCRIÇÃO
7563 COLA BRANCA UNIVERSAL 1 KG
7562 COLA BRANCA UNIVERSAL 500 G

ADESIVOS E QUÍMICOS



CÓD. DESCRIÇÃO
5525 COLA SPRAY REPOSICIONAVEL 340G/500ML



CÓD. DESCRIÇÃO
8087 SPRAY TIRA COLA 100ML



CÓD. DESCRIÇÃO
7934 ADESIVO PU 40 CINZA 400G
7935 ADESIVO PU 40 PRETO 400G
7936 ADESIVO PU 40 BRANCO 400G



CÓD. DESCRIÇÃO
8187 ADESIVO PU 40 FIX BRANCO CONSTRUC. 280ML
8186 ADESIVO PU 40 FIX PRETO CONSTRUC. 280 ML
2992 ADESIVO PU40 FIX CONSTRUC 280ML CZA



CÓD. DESCRIÇÃO
7295 ADESIVO PU 40 BRANCO ULTRA SELANTES 360G
7294 ADESIVO PU 40 CINZA ULTRA SELANTES 360G
7270 ADESIVO PU 40 PRETO ULTRA SELANTES 360G



CÓD. DESCRIÇÃO
8077 ADESIVO DE PU 40 CINZA 360 FLEX
8078 ADESIVO DE PU 40 BRANCO 360 FLEX
8079 ADESIVO DE PU 40 PRETO 360 FLEX



CÓD. DESCRIÇÃO
9027 ADESIVO PU 40 CINZA 80G



CÓD. DESCRIÇÃO
7926 SELA TRINCAS VEDA TRINCA 380GR BRANCO



CÓD. DESCRIÇÃO
8312 SELA TRINCAS 450G BRANCO



CÓD. DESCRIÇÃO
8594 SELA TRINCA UNIPRO BR 400G



CÓD. DESCRIÇÃO
1115 SELA TRINCAS 425G BRANCO



CÓD. DESCRIÇÃO
3127 ESPUMA EXPANSIVA PU 500ML/320G



CÓD. DESCRIÇÃO
8436 ESPUMA EXPANSIVA DE PU 500ML/310G



CÓD. DESCRIÇÃO
1728 SILICONE 270 ML MULT. AC. INCOLOR



CÓD. DESCRIÇÃO
9025 SILICONE 240G ACÉTICO BRANCO
9026 SILICONE 240G ACÉTICO PRETO

ADESIVOS E QUÍMICOS



ULTRA
SOLUÇÕES

CÓD. DESCRIÇÃO
7297 SILICONE 250 ML USO GERAL INCOLOR



Peg & Uze

CÓD. DESCRIÇÃO
8313 SILICONE SPRAY 250ML



quartzolit

CÓD. DESCRIÇÃO
8795 SILICONE 50G ACÉTICO INCOLOR



TEK BOND
SANTO OSÓRIO

CÓD. DESCRIÇÃO
3988 SILICONE SPRAY 300 ML INCOLOR



WD-40

CÓD. DESCRIÇÃO
7441 SILICONE LUB AEROSSOL 420ML WD-40



CIBRA

CÓD. DESCRIÇÃO
7727 SILICONE 50G ACÉTICO INCOLOR



UNIPEGA

CÓD. DESCRIÇÃO
6452 SILICONE 50G INCOLOR



FORTALEZA

CÓD. DESCRIÇÃO
8572 SILICONE 50G ACÉTICO INCOLOR
8573 SILICONE 250G ACÉTICO INCOLOR



TEK BOND
SANTO OSÓRIO

CÓD. DESCRIÇÃO
6503 SILICONE 50 ML MULT. AC. BRANCO



TEK BOND
SANTO OSÓRIO

CÓD. DESCRIÇÃO
5516 SILICONE 50G PRETO BLISTER ALTA TEMP.



TEK BOND
SANTO OSÓRIO

CÓD. DESCRIÇÃO
5517 SILICONE 50G VERMELHO BLISTER ALTA TEMP.



TEK BOND
SANTO OSÓRIO

CÓD. DESCRIÇÃO
1114 SILICONE 50G ACÉTICO TRANSPARENTE



SOLUÇÃO
SANTO OSÓRIO

CÓD. DESCRIÇÃO
7928 FIXA ESPELHO 400GR BCO HÍBRIDO



TEK BOND
SANTO OSÓRIO















CÓD. DESCRIÇÃO
3405 SILICONE 280 ML MULT. AC. BRANCO
3406 SILICONE 280 ML MULT. AC. PRETO



CIBRA

CÓD. DESCRIÇÃO
7726 SILICONE 240G ACÉTICO INCOLOR

ADESIVOS E QUÍMICOS

		
<p>CÓD. DESCRIÇÃO 5514 ARALDITE HOBBY 10 MIN. 23G + TEK BOND INST.</p>	<p>CÓD. DESCRIÇÃO 1431 ARALDITE HOBBY 10MIN. 16G VERMELHA 1430 ARALDITE HOBBY 10MIN. 23G VERMELHA</p>	<p>CÓD. DESCRIÇÃO 7681 ARALDITE RÁPIDO 23G VERDE</p>
		
<p>CÓD. DESCRIÇÃO 7680 ARALDITE PROFISSIONAL 23G AZUL</p>	<p>CÓD. DESCRIÇÃO 5305 MASSA EPOXI 50G ARALDITE 4554 MASSA EPOXI 100G ARALDITE</p>	<p>CÓD. DESCRIÇÃO 8421 MASSA PARA CALAFETAR</p>
		
<p>CÓD. DESCRIÇÃO 1341 VEDA CALHA TEK BOND 280G ALUMINIO</p>	<p>CÓD. DESCRIÇÃO 8670 VEDA CALHA UNIPRO CINZA 400G</p>	<p>CÓD. DESCRIÇÃO 5525 COLA SPRAY REPOSICIONAVEL 340G/500ML</p>
		
<p>CÓD. DESCRIÇÃO 8087 SPRAY TIRA COLA 100ML</p>	<p>CÓD. DESCRIÇÃO 6799 COLA MADEIRA 90G ALMAFLEX</p>	<p>CÓD. DESCRIÇÃO 5523 COLA MADEIRA 100G - TEK BOND 5524 COLA MADEIRA 250G - TEK BOND</p>
		
<p>CÓD. DESCRIÇÃO 7303 DESENGRIPANTE SPRAY 300ML LEVEUZE</p>	<p>CÓD. DESCRIÇÃO 5696 DESENGRIPANTE SPRAY WHITE LUB 300ML/209G</p>	<p>CÓD. DESCRIÇÃO 8188 DESENGRIPANTE SPRAY 250 ML</p>

ADESIVOS E QUÍMICOS



CÓD. DESCRIÇÃO
5647 DESENGRIPANTE SPRAY 300ML WD40
9034 DESENGRIPANTE SPRAY 100ML WD40



CÓD. DESCRIÇÃO
8809 DESENGRIPANTE SPRAY ULTRA LUB 300ML



CÓD. DESCRIÇÃO
6223 VASELINA SOLIDA 100 GR NOVA
6228 VASELINA SOLIDA 400 GR NOVA



CÓD. DESCRIÇÃO
6222 VASELINA LIQUIDA 500 ML NOVA



CÓD. DESCRIÇÃO
6226 GRAXA BRANCA 500G NOVA



CÓD. DESCRIÇÃO
6224 GRAXA CA2 100GR NOVA
6225 GRAXA CA2 500GR NOVA



CÓD. DESCRIÇÃO
5531 GRAXA BRANCA SPRAY 200G/300ML



CÓD. DESCRIÇÃO
3987 LIMPA CONTATO SPRAY 300ML



CÓD. DESCRIÇÃO
5702 LIMPA CONTATOS 300ML/209G



CÓD. DESCRIÇÃO
5530 GRAFITE SPRAY SECO 200ML/100G



CÓD. DESCRIÇÃO
7440 LUBRIFICANTE PMU FLEXTOP AEROSSOL 500ML



CÓD. DESCRIÇÃO
8723 FITA SILVER TAPE REFORÇADA 48MMX5M



CÓD. DESCRIÇÃO
2087 FITA SILVER TAPE PRATA 48 MM X 5 M
65437679 FITA SILVER TAPE AZUL 48 MM X 5M
7679 FITA SILVAR TAPE PRETA 48MMX5M



CÓD. DESCRIÇÃO
4551 FITA DE DEMARCAÇÃO AMARELA 48MMx15M
5527 FITA DE DEMARCAÇÃO VERMELHA 48MMx15M



CÓD. DESCRIÇÃO
1118 FITA CREPE 18 MM X 50M
11191120 FITA CREPE 24 MM X 50M
1120 FITA CREPE 48 MM X 50M

**TEK
BOND**

SAINT-GOBAIN

A GENTE COLA COM VOCÊ

Imagens meramente ilustrativas



Descubra as soluções que a Tekbond oferece em:
TEKBOND.COM.BR [TEKBONDoficial](https://www.facebook.com/TEKBONDoficial)

SAINT-GOBAIN

ADESIVOS E QUÍMICOS



3M

CÓD.	DESCRIÇÃO
4305	FITA CREPE 18MM X 50MM 101LA
43064307	FITA CREPE 24MM X 50MM 101LA
4307	FITA CREPE 48MM X 50MM 101LA



adelbras

CÓD.	DESCRIÇÃO
7691	FITA CREPE ADELBRAS 18MM X 40M
7692	FITA CREPE ADELBRAS 24MM X 40M
7693	FITA CREPE ADELBRAS 48MM X 40M



adelbras

CÓD.	DESCRIÇÃO
8619	FITA CREPE ADELBRAS 710 18MM X 50M
8620	FITA CREPE ADELBRAS 710 24MM X 50M
8621	FITA CREPE ADELBRAS 710 48MM X 50M



adelbras

CÓD.	DESCRIÇÃO
8616	FITA CREPE AZUL 722 IMOBILIARIA 18MMX50M
8617	FITA CREPE AZUL 722 IMOBILIARIA 24MMX50M
8618	FITA CREPE AZUL 722 IMOBILIARIA 48MMX50M



TEK BOND

CÓD.	DESCRIÇÃO
7392	FITA P/ EMBALAGEM TRANSP 48MM X 40M



TEK BOND

CÓD.	DESCRIÇÃO
7676	FITA PARA EMBALAGEM MARRON 48MM X 40M



alltape

CÓD.	DESCRIÇÃO
7228	FITA P/ EMBALAGEM MARRON 45MM X 45M
7227	FITA P/ EMBALAGEM TRANSPARENTE 45MM X 45M



BOMVINK

CÓD.	DESCRIÇÃO
8413	FITA SILVER TAPE PRATA 45MMX5M



3M

CÓD.	DESCRIÇÃO
4303	FITA P/ EMBALAGEM TRANSPARENTE 48MM X 50M
4304	FITA P/ EMBALAGEM MARRON 45MM X 45M



adelbras

CÓD.	DESCRIÇÃO
8623	FITA P/ EMBALAGEM MARRON 48MM X 40M
8622	FITA P/ EMBALAGEM TRANSP. 48MM X 40M



3M

CÓD.	DESCRIÇÃO
4447	FITA DUPLA FACE 12MM X 3M AUTOMOTIVA



3M

CÓD.	DESCRIÇÃO
7721	FITA DUPLA FACE 12MM X 20 METROS 3M



3M

CÓD.	DESCRIÇÃO
4445	FITA DUPLA FACE 24MM X 2M EXTREME FIXA FORTE



3M

CÓD.	DESCRIÇÃO
4302	FITA DUPLA FACE 12MM X 2M FIXA FORTE
4446	FITA DUPLA FACE 19MM X 2M FIXA FORTE
4397	FITA DUPLA FACE 12MM X 1.5M FIXA FORTE USO INT
4398	FITA DUPLA FACE 24MM X 1.5M FIXA FORTE USO INT



TEK BOND

CÓD.	DESCRIÇÃO
4552	FITA DUPLA FACE 12MM x 2M BLISTER TEKBOND
4553	FITA DUPLA FACE 19MM x 2M BLISTER TEKBOND

ADESIVOS E QUÍMICOS



Bestfer

CÓD. DESCRIÇÃO
7815 FITA ZEBRADA ADVERTÊNCIA AMARELA/PRETA 100M



SEAL TAPE

CÓD. DESCRIÇÃO
1097 FITA ZEBRADA PT/AM 70 MM X 160 M



ATLAS

CÓD. DESCRIÇÃO
5357 PROTETOR ADESIVO 10X20CM FELTRO C/DUPLA FACE



ATLAS

CÓD. DESCRIÇÃO
5356 ADESIVO ANTI IMPACTO 0,8CM COM 28 PEÇAS PVC



ATLAS

CÓD. DESCRIÇÃO
5361 PROTETOR ADESIVO 10X10 CM EVA PRETO



TEK BOND

CÓD. DESCRIÇÃO
3989 FITA ANTIDERRAPANTE PRETA(5 CM X 5 M)
3990 FITA ANTIDERRAPANTE TRANSPARENTE (5 CM X 5 M)



3M

CÓD. DESCRIÇÃO
7790 FITA DUPLA FACE 12MM X 5 METROS 3M ESTOJO



DOUBLE TAPE

CÓD. DESCRIÇÃO
5567 FITA DUPLA FACE 12MM X 1M D.T. ULTRA EX. FORTE
5566 FITA DUPLA FACE 15MM X 1,5M D.T. ULTRA EX. FORTE



adebras

CÓD. DESCRIÇÃO
8624 FITA DUPLA FACE 12MM X02M VERDE
8627 FITA DUPLA FACE 12MM X20M VERDE
8625 FITA DUPLA FACE 19MM X02M VERDE
8626 FITA DUPLA FACE 24MM X 02M VERDE



TEK BOND

CÓD. DESCRIÇÃO
5528 FITA DUPLA FACE ESPUMA 19MMX1,5M TEKBOND

IMPERMEABILIZANTES

ULTRA
/// ATACADISTA

Nova

TINTAS E IMPERMEABILIZANTES















*Você conhece,
você confia!*

Pra que arriscar se
você pode **acertar
de primeira?**















Invista nas melhores
soluções para sua obra
com a **Nova Tintas e
Impermeabilizantes**



IMPERMEABILIZANTES

		
<p>CÓD. DESCRIÇÃO</p> <p>6214 NOVAPREN PRETO 18L MANTA LIQUIDA LAJE 621562 NOVAPREN PRETO 3,6L MANTA LIQUIDA LAJE 621862 NOVAPREN BRANCO 18KG MANTA LIQUIDA LAJE 6219 NOVAPREN BRANCO 3,6 KG MANTA LIQUIDA LAJE</p>	<p>CÓD. DESCRIÇÃO</p> <p>6216 NOVAPREN PAREDE 18L 6217 NOVAPREN PAREDE 3,6L</p>	<p>CÓD. DESCRIÇÃO</p> <p>4465 NOVAFIX/CHAPISCO 1L (FARDO C/ 06 UN) 44664467 NOVAFIX/CHAPISCO 3,6L (FARDO C/ 04 UN) 4467 NOVAFIX/CHAPISCO 18L</p>
		
<p>CÓD. DESCRIÇÃO</p> <p>4468 NOVAMASSA 1L (VEDACIT) FARDO C/ 06 UN 44694470 NOVAMASSA 3,6L (VEDACIT) FARDO C/ 04 UN 4470 NOVAMASSA 18L (VEDACIT)</p>	<p>CÓD. DESCRIÇÃO</p> <p>4475 NOVALIGA 1L (VEDALIT) FARDO C/ 06 UN 44764477 NOVALIGA 3,6L (VEDALIT) FARDO C/ 04 UN 4477 NOVALIGA 18L (VEDALIT)</p>	<p>CÓD. DESCRIÇÃO</p> <p>4473 NOVATROL 18L</p>
		
<p>CÓD. DESCRIÇÃO</p> <p>4472 NOVATROL 3,6L (FARDO C/04)</p>	<p>CÓD. DESCRIÇÃO</p> <p>4471 NOVATROL 1L (FARDO C/06)</p>	<p>CÓD. DESCRIÇÃO</p> <p>4474 NOVATOP ARGAMASSA POLIMERICA 18KG</p>
		
<p>CÓD. DESCRIÇÃO</p> <p>1474 VEDAPREN PRETO 3,6 L 1364 VEDAPREN PRETO 18 L</p>	<p>CÓD. DESCRIÇÃO</p> <p>5682 VEDAPREN PAREDE 18 L 5680 VEDAPREN PAREDE 3,6 KG</p>	<p>CÓD. DESCRIÇÃO</p> <p>5678 VEDAPREN BRANCO 4,5 KG 5681 VEDAPREN BRANCO 18 KG</p>
		
<p>CÓD. DESCRIÇÃO</p> <p>1266 VEDACIT 900 ML 12651255 VEDACIT GL 3,6L 1255 VEDACIT 18L BALDE</p>	<p>CÓD. DESCRIÇÃO</p> <p>1260 BIANCO 1 L POTE 12591258 BIANCO 3,6 L GL 1258 BIANCO 18 L BALDE</p>	<p>CÓD. DESCRIÇÃO</p> <p>1761 NEUTROL ACQUA 3,6 L 17601759 NEUTROL ACQUA 900 ML 1759 NEUTROL ACQUA 18 L BALDE</p>

IMPERMEABILIZANTES

																										
<table border="1"> <thead> <tr> <th>CÓD.</th> <th>DESCRIÇÃO</th> </tr> </thead> <tbody> <tr> <td>2582</td> <td>VEDALIT 900 ML</td> </tr> <tr> <td>26403288</td> <td>VEDALIT 3,6 L</td> </tr> <tr> <td>3288</td> <td>VEDALIT 18 L</td> </tr> </tbody> </table>	CÓD.	DESCRIÇÃO	2582	VEDALIT 900 ML	26403288	VEDALIT 3,6 L	3288	VEDALIT 18 L	<table border="1"> <thead> <tr> <th>CÓD.</th> <th>DESCRIÇÃO</th> </tr> </thead> <tbody> <tr> <td>5675</td> <td>PRIMER ASFALTO BASE ÁGUA 3,6 L</td> </tr> <tr> <td>5677</td> <td>PRIMER ASFALTO BASE ÁGUA 1 L</td> </tr> </tbody> </table>	CÓD.	DESCRIÇÃO	5675	PRIMER ASFALTO BASE ÁGUA 3,6 L	5677	PRIMER ASFALTO BASE ÁGUA 1 L	<table border="1"> <thead> <tr> <th>CÓD.</th> <th>DESCRIÇÃO</th> </tr> </thead> <tbody> <tr> <td>1264</td> <td>NEUTROL 900 ML</td> </tr> <tr> <td>12611256</td> <td>NEUTROL 3,6 L LATA</td> </tr> <tr> <td>1256</td> <td>NEUTROL 18 L LATA</td> </tr> </tbody> </table>	CÓD.	DESCRIÇÃO	1264	NEUTROL 900 ML	12611256	NEUTROL 3,6 L LATA	1256	NEUTROL 18 L LATA		
CÓD.	DESCRIÇÃO																									
2582	VEDALIT 900 ML																									
26403288	VEDALIT 3,6 L																									
3288	VEDALIT 18 L																									
CÓD.	DESCRIÇÃO																									
5675	PRIMER ASFALTO BASE ÁGUA 3,6 L																									
5677	PRIMER ASFALTO BASE ÁGUA 1 L																									
CÓD.	DESCRIÇÃO																									
1264	NEUTROL 900 ML																									
12611256	NEUTROL 3,6 L LATA																									
1256	NEUTROL 18 L LATA																									
																										
<table border="1"> <thead> <tr> <th>CÓD.</th> <th>DESCRIÇÃO</th> </tr> </thead> <tbody> <tr> <td>7999</td> <td>MANTA FITA ALUMÍNIO VEDATUDO 30 CM</td> </tr> <tr> <td>8000</td> <td>MANTA FITA ALUMÍNIO VEDATUDO 10 CM</td> </tr> <tr> <td>8001</td> <td>MANTA FITA ALUMÍNIO VEDATUDO 20 CM</td> </tr> </tbody> </table>	CÓD.	DESCRIÇÃO	7999	MANTA FITA ALUMÍNIO VEDATUDO 30 CM	8000	MANTA FITA ALUMÍNIO VEDATUDO 10 CM	8001	MANTA FITA ALUMÍNIO VEDATUDO 20 CM	<table border="1"> <thead> <tr> <th>CÓD.</th> <th>DESCRIÇÃO</th> </tr> </thead> <tbody> <tr> <td>3128</td> <td>MANTA FITA ALUMINIO 30 CM</td> </tr> </tbody> </table>	CÓD.	DESCRIÇÃO	3128	MANTA FITA ALUMINIO 30 CM	<table border="1"> <thead> <tr> <th>CÓD.</th> <th>DESCRIÇÃO</th> </tr> </thead> <tbody> <tr> <td>5673</td> <td>TELA POLIESTER RL 49 CM X 50 M VEDACIT</td> </tr> </tbody> </table>	CÓD.	DESCRIÇÃO	5673	TELA POLIESTER RL 49 CM X 50 M VEDACIT								
CÓD.	DESCRIÇÃO																									
7999	MANTA FITA ALUMÍNIO VEDATUDO 30 CM																									
8000	MANTA FITA ALUMÍNIO VEDATUDO 10 CM																									
8001	MANTA FITA ALUMÍNIO VEDATUDO 20 CM																									
CÓD.	DESCRIÇÃO																									
3128	MANTA FITA ALUMINIO 30 CM																									
CÓD.	DESCRIÇÃO																									
5673	TELA POLIESTER RL 49 CM X 50 M VEDACIT																									
																										
<table border="1"> <thead> <tr> <th>CÓD.</th> <th>DESCRIÇÃO</th> </tr> </thead> <tbody> <tr> <td>1823</td> <td>VEDATOP CAIXA 3KG MONOCOMPONENTE</td> </tr> </tbody> </table>	CÓD.	DESCRIÇÃO	1823	VEDATOP CAIXA 3KG MONOCOMPONENTE	<table border="1"> <thead> <tr> <th>CÓD.</th> <th>DESCRIÇÃO</th> </tr> </thead> <tbody> <tr> <td>5674</td> <td>COMPOUND ADESIVO EPOXI 1 KG VEDACIT</td> </tr> </tbody> </table>	CÓD.	DESCRIÇÃO	5674	COMPOUND ADESIVO EPOXI 1 KG VEDACIT	<table border="1"> <thead> <tr> <th>CÓD.</th> <th>DESCRIÇÃO</th> </tr> </thead> <tbody> <tr> <td>7210</td> <td>PINTURA ASFALTICA ACQUA QUARTZOLIT 1L</td> </tr> <tr> <td>7206</td> <td>PINTURA ASFALTICA ACQUA QUARTZOLIT 3,6L</td> </tr> <tr> <td>7239</td> <td>PINTURA ASFALTICA ACQUA QUARTZOLIT 18 L</td> </tr> </tbody> </table>	CÓD.	DESCRIÇÃO	7210	PINTURA ASFALTICA ACQUA QUARTZOLIT 1L	7206	PINTURA ASFALTICA ACQUA QUARTZOLIT 3,6L	7239	PINTURA ASFALTICA ACQUA QUARTZOLIT 18 L								
CÓD.	DESCRIÇÃO																									
1823	VEDATOP CAIXA 3KG MONOCOMPONENTE																									
CÓD.	DESCRIÇÃO																									
5674	COMPOUND ADESIVO EPOXI 1 KG VEDACIT																									
CÓD.	DESCRIÇÃO																									
7210	PINTURA ASFALTICA ACQUA QUARTZOLIT 1L																									
7206	PINTURA ASFALTICA ACQUA QUARTZOLIT 3,6L																									
7239	PINTURA ASFALTICA ACQUA QUARTZOLIT 18 L																									
																										
<table border="1"> <thead> <tr> <th>CÓD.</th> <th>DESCRIÇÃO</th> </tr> </thead> <tbody> <tr> <td>7201</td> <td>PINTURA EMBORR. PAREDE QUARTZOLIT 3,6KG</td> </tr> <tr> <td>7238</td> <td>PINTURA EMBORR. PAREDE QUARTZOLIT 18 KG</td> </tr> </tbody> </table>	CÓD.	DESCRIÇÃO	7201	PINTURA EMBORR. PAREDE QUARTZOLIT 3,6KG	7238	PINTURA EMBORR. PAREDE QUARTZOLIT 18 KG	<table border="1"> <thead> <tr> <th>CÓD.</th> <th>DESCRIÇÃO</th> </tr> </thead> <tbody> <tr> <td>7586</td> <td>MANTA LÍQUIDA PRETA 3,6KG</td> </tr> <tr> <td>7585</td> <td>MANTA LÍQUIDA PRETA 18KG</td> </tr> <tr> <td>7587</td> <td>MANTA LÍQUIDA BRANCA 4,5KG</td> </tr> <tr> <td>7584</td> <td>MANTA LÍQUIDA BRANCA 18KG</td> </tr> </tbody> </table>	CÓD.	DESCRIÇÃO	7586	MANTA LÍQUIDA PRETA 3,6KG	7585	MANTA LÍQUIDA PRETA 18KG	7587	MANTA LÍQUIDA BRANCA 4,5KG	7584	MANTA LÍQUIDA BRANCA 18KG	<table border="1"> <thead> <tr> <th>CÓD.</th> <th>DESCRIÇÃO</th> </tr> </thead> <tbody> <tr> <td>7197</td> <td>ADITIVO PLASTIFICANTE QUARTZOLIT 18L BALDE</td> </tr> <tr> <td>7199</td> <td>ADITIVO PLASTIFICANTE QUARTZOLIT 3,6L</td> </tr> <tr> <td>7200</td> <td>ADITIVO PLASTIFICANTE QUARTZOLIT 1 L</td> </tr> </tbody> </table>	CÓD.	DESCRIÇÃO	7197	ADITIVO PLASTIFICANTE QUARTZOLIT 18L BALDE	7199	ADITIVO PLASTIFICANTE QUARTZOLIT 3,6L	7200	ADITIVO PLASTIFICANTE QUARTZOLIT 1 L
CÓD.	DESCRIÇÃO																									
7201	PINTURA EMBORR. PAREDE QUARTZOLIT 3,6KG																									
7238	PINTURA EMBORR. PAREDE QUARTZOLIT 18 KG																									
CÓD.	DESCRIÇÃO																									
7586	MANTA LÍQUIDA PRETA 3,6KG																									
7585	MANTA LÍQUIDA PRETA 18KG																									
7587	MANTA LÍQUIDA BRANCA 4,5KG																									
7584	MANTA LÍQUIDA BRANCA 18KG																									
CÓD.	DESCRIÇÃO																									
7197	ADITIVO PLASTIFICANTE QUARTZOLIT 18L BALDE																									
7199	ADITIVO PLASTIFICANTE QUARTZOLIT 3,6L																									
7200	ADITIVO PLASTIFICANTE QUARTZOLIT 1 L																									
																										
<table border="1"> <thead> <tr> <th>CÓD.</th> <th>DESCRIÇÃO</th> </tr> </thead> <tbody> <tr> <td>7205</td> <td>TECPLUS TOP QUARTZOLIT 18KG</td> </tr> </tbody> </table>	CÓD.	DESCRIÇÃO	7205	TECPLUS TOP QUARTZOLIT 18KG	<table border="1"> <thead> <tr> <th>CÓD.</th> <th>DESCRIÇÃO</th> </tr> </thead> <tbody> <tr> <td>7207</td> <td>TECPLUS 1 QUARTZOLIT 1L</td> </tr> <tr> <td>7208</td> <td>TECPLUS 1 QUARTZOLIT 3,6L</td> </tr> <tr> <td>7229</td> <td>TECPLUS 1 QUARTZOLIT BD 18L</td> </tr> </tbody> </table>	CÓD.	DESCRIÇÃO	7207	TECPLUS 1 QUARTZOLIT 1L	7208	TECPLUS 1 QUARTZOLIT 3,6L	7229	TECPLUS 1 QUARTZOLIT BD 18L	<table border="1"> <thead> <tr> <th>CÓD.</th> <th>DESCRIÇÃO</th> </tr> </thead> <tbody> <tr> <td>7198</td> <td>CHAPIX BLANCO QUARTZOLIT 1 L</td> </tr> <tr> <td>7209</td> <td>CHAPIX BLANCO QUARTZOLIT - GL 3,6L</td> </tr> <tr> <td>7230</td> <td>CHAPIX BLANCO QUARTZOLIT - BD 18L</td> </tr> </tbody> </table>	CÓD.	DESCRIÇÃO	7198	CHAPIX BLANCO QUARTZOLIT 1 L	7209	CHAPIX BLANCO QUARTZOLIT - GL 3,6L	7230	CHAPIX BLANCO QUARTZOLIT - BD 18L				
CÓD.	DESCRIÇÃO																									
7205	TECPLUS TOP QUARTZOLIT 18KG																									
CÓD.	DESCRIÇÃO																									
7207	TECPLUS 1 QUARTZOLIT 1L																									
7208	TECPLUS 1 QUARTZOLIT 3,6L																									
7229	TECPLUS 1 QUARTZOLIT BD 18L																									
CÓD.	DESCRIÇÃO																									
7198	CHAPIX BLANCO QUARTZOLIT 1 L																									
7209	CHAPIX BLANCO QUARTZOLIT - GL 3,6L																									
7230	CHAPIX BLANCO QUARTZOLIT - BD 18L																									

IMPERMEABILIZANTES



quartzolit

CÓD.	DESCRIÇÃO
8636	REJUNTE PORCELANATOS BRANCO 1KG
8640	REJUNTE PORCELANATOS CINZA ÁRTICO 1KG
8639	REJUNTE PORCELANATOS CINZA OUTONO 1KG
8638	REJUNTE PORCELANATOS CINZA PLATINA 1KG
8637	REJUNTE PORCELANATOS MARFIM 1KG
8641	REJUNTE PORCELANATOS MARRON CAFÉ 1KG
8642	REJUNTE PORCELANATOS MARRON TABACO 1KG
8643	REJUNTE PORCELANATOS PRETO GRAFITE 1KG



quartzolit

CÓD.	DESCRIÇÃO
7193	REJUNTE CERAMICAS BEGE 1KG
7194	REJUNTE CERAMICAS BRANCO 1KG
7195	REJUNTE CERAMICAS CINZA PLATINA 1KG
7196	REJUNTE CERAMICAS CINZA ARTICO 1KG
7202	REJUNTE CERAMICAS PRETO GRAFITE 1KG
7203	REJUNTE CERAMICAS MARROM CAFE 1KG
7204	REJUNTE CERAMICAS CINZA OUTONO 1KG
7248	REJUNTE CERAMICAS CORDA 1KG
7588	REJUNTE CERAMICAS MARRON TABACO 1KG
7589	REJUNTE CERAMICAS PALHA 1KG



quartzolit

CÓD.	DESCRIÇÃO
8650	REJUNTE CERAMICAS BEGE 5KG
8644	REJUNTE CERAMICAS BRANCO 5KG
8649	REJUNTE CERAMICAS CINZA ARTICO 5KG
8648	REJUNTE CERAMICAS CINZA OUTONO 5KG
8645	REJUNTE CERAMICAS CINZA PLATINA 5KG
8646	REJUNTE CERAMICAS MARRON TABACO 5KG
8647	REJUNTE CERAMICAS PRETO GRAFITE 5KG



quartzolit

CÓD.	DESCRIÇÃO
7961	TELA MINI ESTRUTURANTE 21 CM X 5 METROS



brasilit

CÓD.	DESCRIÇÃO
7187	MANTA FITA ALUMINIO 10 CM BRASILIT (10 MT)
7188	MANTA FITA ALUMINIO 15 CM BRASILIT (10 MT)
7189	MANTA FITA ALUMINIO 20 CM BRASILIT (10 MT)
7190	MANTA FITA ALUMINIO 30 CM BRASILIT (10 MT)
7191	MANTA FITA ALUMINIO 45 CM BRASILIT (10 MT)
7564	MANTA FITA ALUMÍNIO 60CM BRASILIT (10MT)
7192	MANTA FITA ALUMINIO 90 CM BRASILIT (10 MT)

QUANDO ESSA SELEÇÃO ENTRA SUA LOJA SÓ FATURA!

NOVALIGA ADITIVO PLASTIFICANTE PARA ARGAMASSAS

NOVAMASSA ADITIVO IMPERMEABILIZANTE PARA CONCRETOS E ARGAMASSAS

NOVATROL ASFALTO LÍQUIDO IMPERMEABILIZANTE ALVENARIA - MADEIRA - METAL

NOVAFIX CHAPISCO ADESIVO PARA CHAPISCO E ARGAMASSAS

NOVATOP ARGAMASSA DE PORTA-FECHAMENTO IMPERMEABILIZANTE PARA LAJE

NOVAPREN PAREDE

NOVAPREN BRANCO

NOVAPREN

Nova
TINTAS E IMPERMEABILIZANTES

AGROPECUÁRIA

ULTRA
/// ATACADISTA

ULTRA

LINHA AGROPECUÁRIA

ARAME FARPADO 1,60MM

6664	100M
6665	250M
6666	500M



7373 - ARAME OVALADO 2,2X2,7MM 1000M



MANGUEIRA AMARELA 1/2 SILICONE

3086	100M
3012	200M
3011	300M



MANGUEIRA LARANJA 1/2 SILICONE

3009	100M
4315	200M
3010	300M



7036 - LÂMINA PARA ROÇADEIRA 350 X 1,8 FURO 20MM

7015 - PÁ DE BICO N4 COM CABO Y



7018 - CAVADEIRA ARTICULADA COM CABO 1,25M



1065 - CABO ENXADA CAIPIRA



7010 - ENXADA LARGA 2,5LB COM CABO 1,50M



ULTRA

/// TELAS

ULTRA
TELA HEXAGONAL
VIVEIRO

MALHA TIPO
1/2
COMPRIMENTO
50M
ALTURA
1,50M
DIÂMETRO DO FIO
BWG26



ULTRA
TELA HEXAGONAL
GALINHEIRO

MALHA TIPO
2
COMPRIMENTO
50M
ALTURA
1,50M
DIÂMETRO DO FIO
BWG23



ULTRA
TELA HEXAGONAL
PINTEIRO

MALHA TIPO
1
COMPRIMENTO
50M
ALTURA
1,50M
DIÂMETRO DO FIO
BWG22



ULTRA
TELA HEXAGONAL
MANGUEIRÃO

MALHA TIPO
3
COMPRIMENTO
50M
ALTURA
1,50M
DIÂMETRO DO FIO
BWG18



**Telas produzidas
com qualidade
reforçadas e
com menor preço.
Veja os códigos
na página 37 e
solicite
orçamento.**



THOMPSON

CÓD. DESCRIÇÃO
5129 MACHADINHA C/ CABO FIBRA DE VIDRO 600G



São Romão

CÓD. DESCRIÇÃO
1369 MACHADINHA CABO MADEIRA SÃO ROMÃO



São Romão

CÓD. DESCRIÇÃO
1340 MACHADINHA MARTELO UNHA



BOMVINK

CÓD. DESCRIÇÃO
8246 MACHADINHA TÁTICO MARTELO UNHA 3 EM 1



TRAMONTINA

CÓD. DESCRIÇÃO
4633 PICARETA CHIBANCA C/ CABO
4641 PICARETA CHIBANCA S/ CABO



TRAMONTINA

CÓD. DESCRIÇÃO
6200 PICARETA ALVIAO C/ CABO
4638 PICARETA ALVIAO S/ CABO



TRAMONTINA

CÓD. DESCRIÇÃO
4642 PICARETA ESTREITA S/ CABO
7706 PICARETA ESTREITA COM CABO



MINASUL

CÓD. DESCRIÇÃO
1557 PICARETA CHIBANCA C/ CABO
1556 PICARETA CHIBANCA S/ CABO



MINASUL

CÓD. DESCRIÇÃO
4151 PICARETA ALVIÃO C/ CABO
4154 PICARETA ALVIÃO S/ CABO



TRAMONTINA

CÓD. DESCRIÇÃO
4634 SACHO 2 PONTAS C/CABO



TRAMONTINA

CÓD. DESCRIÇÃO
4636 SACHO 1 PONTA C/CABO



MINASUL

CÓD. DESCRIÇÃO
4152 PICARETA PÁ E PONTA C/ CABO
4153 PICARETA PÁ E PONTA S/ CABO



TRAMONTINA

CÓD. DESCRIÇÃO
4647 CONJ. P/ JARDIM 3 PC MET. C/CAB. MAD.



Bestfer

CÓD. DESCRIÇÃO
7641 KIT FERRAMENTAS PARA JARDINAGEM KIT 3 PEÇAS



BOMVINK

CÓD. DESCRIÇÃO
8253 KIT FERRAMENTAS PARA JARDINAGEM KIT 3 PEÇAS

AGROPECUÁRIA



TRAMONTINA

CÓD. 4648
 DESCRIÇÃO TESOURA GRAMA CERCA-VIVA



CÓD. 6929
 DESCRIÇÃO FAÇÃO CANA PEITO DE POMBA 14 POLEGADAS DUAS CARAS



THOMPSON

CÓD. 1801
 1802
 DESCRIÇÃO TESOURA PODA 7"
 TESOURA PODA 8"



TRAMONTINA

CÓD. 4646
 DESCRIÇÃO TESOURA PODA BYPASS TRAMONTINA



BOMVINK

CÓD. 8438
 DESCRIÇÃO TESOURA GRAMA - CERCA VIVA



BOMVINK

CÓD. 8330
 DESCRIÇÃO TESOURA PODA BYPASS



CÓD. 7155
 10231022
 10221571
 1571
 DESCRIÇÃO CHAVE DE VIRAR FERRO 1/4
 CHAVE DE VIRAR FERRO 1/2
 CHAVE DE VIRAR FERRO 3/8
 CHAVE DE VIRAR FERRO 5/16



CÓD. 8422
 2816
 DESCRIÇÃO PÉ DE CABRA AÇO LISO 50CM
 PÉ DE CABRA AÇO LISO 60 CM



CÓD. 5916
 5917
 DESCRIÇÃO ALAVANCA ACO LISO 1" X 1.50M SAO ROMAO
 ALAVANCA ACO LISO 7/8 X 1.50M SAO ROMAO



CÓD. 1564
 DESCRIÇÃO CAVADEIRA MOURAO RETA C/ SOCADOR TUBULAR



CÓD. 3293
 DESCRIÇÃO PROLONGADOR P/ CAVADEIRA TRADO 3/4



CÓD. 1565
 1563
 DESCRIÇÃO CAVADEIRA RETA C/CABO 1,5M MADEIRA
 CAVADEIRA MOURAO RETA S/CABO



TRAMONTINA

CÓD. 4644
 DESCRIÇÃO CAVADEIRA RETA S/ CABO

















CÓD. 1562
 15614591
 45914592
 4592
 DESCRIÇÃO CAVADEIRA ART. N2 C/CABO 1,5M
 CAVADEIRA ART. STANDARD C/ CABO 1,2M
 CAVADEIRA ART. LIGHT C/CABO 1,8M
 CAV. ART. LIGHT TUCANO C/CABO 1,8M

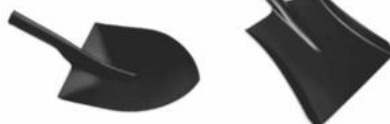

CÓD. 3291
 3292
 DESCRIÇÃO CAVADEIRA TRADO C/ CABO TUBO N08
 CAVADEIRA TRADO C/ CABO TUBO N10

AGROPECUÁRIA

 <p>MINASUL</p>	 <p>TRAMONTINA</p>	 <p>PACETTA QUALIDADE EM FERRAMENTAS</p>
<p>CÓD. DESCRIÇÃO 7711 CABO PARA PICARETA COM CUNHA POLIETILENO</p>	<p>CÓD. DESCRIÇÃO 4630 CAVADEIRA ART. C/CABO 110CM</p>	<p>CÓD. DESCRIÇÃO 2178 CAVADEIRA ART. C/CABO PACETTA</p>
 <p>TRAMONTINA</p>	 <p>INDUSTRIA FERRAMENTAS</p>	 <p>FERRAMENTAS São Romão</p>
<p>CÓD. DESCRIÇÃO 4629 FOICE ROÇADEIRA C/ CABO 4639 FOICE ROÇADEIRA S/ CABO</p>	<p>CÓD. DESCRIÇÃO 6922 CAVADEIRA ARTICULADA 1,2M SERVENTE</p>	<p>CÓD. DESCRIÇÃO 5919 CAVADEIRA ARTICULADA C/CABO SAO ROMAO</p>
 <p>ULTRA</p>	 <p>TRAMONTINA</p>	 <p>TRAMONTINA</p>
<p>CÓD. DESCRIÇÃO 7018 CAVADEIRA ARTICULADA COM CABO 1,25m</p>	<p>CÓD. DESCRIÇÃO 6638 MACHADO SOLDADO TAMANHO 3.5 COM CABO</p>	<p>CÓD. DESCRIÇÃO 4643 MACHADO SOLDADO 3.5 S/ CABO TRAMONTINA</p>
 <p>MINASUL</p>	 <p>MINASUL</p>	 <p>TRAMONTINA</p>
<p>CÓD. DESCRIÇÃO 1569 PA QUADRADA N4 C/ CABO Y 1570 PA DE BICO N4 C/ CABO RETO</p>	<p>CÓD. DESCRIÇÃO 1566 PA DE BICO N4 S/ CABO 1567 PA QUADRADA N4 S/ CABO</p>	<p>CÓD. DESCRIÇÃO 6518 PA DE BICO C/ CABO Y N4 7063 PA DE BICO C/ CABO Y N3</p>
 <p>MAX FERRAMENTAS</p>	 <p>ULTRA</p>	 <p>TRAMONTINA</p>
<p>CÓD. DESCRIÇÃO 8929 PA DE BICO N4 C/ CABO Y</p>	<p>CÓD. DESCRIÇÃO 7015 PA DE BICO COM N4 COM CABO Y</p>	<p>CÓD. DESCRIÇÃO 4631 PA QUADRADA C/ CABO Y</p>



PACETTA

CÓD.	DESCRIÇÃO
2177	MACHADO JS 334 R.C. S/CABO PACETTA
4882	MACHADO JS 334 R.C. C/CABO PACETTA



TRAMONTINA

CÓD.	DESCRIÇÃO
5141	PA DE BICO S/ CABO N4



ULTRA

CÓD.	DESCRIÇÃO
7007	CABO PARA PA Y 72 CM



MINASUL

CÓD.	DESCRIÇÃO
5081	CABO PARA MACHADO 0,95 METROS
5082	CABO PÁ RETO 1,20 METROS
5083	CABO PARA PÁ Y
5084	CABO PARA PICARETA 0,95 METROS



PACETTA

CÓD.	DESCRIÇÃO
2846	ENXADA LARGA S/ CABO 2.5 PACETTA
2845	ENXADA LARGA COM CABO 2.5 PACETTA



ULTRA

CÓD.	DESCRIÇÃO
7012	ENXADA LARGA 2,5 LIBRAS SEM CABO



MINASUL

CÓD.	DESCRIÇÃO
1821	ENXADA LARGA S/ CABO 300X250 MINASUL
2186	ENXADA LARGA GOIVADA 2,5 LB COM CABO 1.50M



TRAMONTINA

CÓD.	DESCRIÇÃO
4635	ENXADAO ESTREITO 2,5 LB S/CABO TRAMONTINA
46264637	ENXADAO LARGO 2,5 LB C/CABO TRAMONTINA
4637	ENXADAO LARGO 2,5 LB S/CABO TRAMONTINA



MINASUL

CÓD.	DESCRIÇÃO
1822	ENXADAO LARGO S/ CABO 280X140MM MINASUL
2187	ENXADAO LARGO COM CABO 280X140MM MINASUL



TRAMONTINA

CÓD.	DESCRIÇÃO
4627	ENXADA ESTREITA 2,5 LB C/ CABO
4628	ENXADA LARGA 2,5 LB C/CABO GOIVADA



INDUSTRIA PEGARRI

CÓD.	DESCRIÇÃO
6908	ENXADÃO ESTREITO 3,0 LB ALPE



INDUSTRIA PEGARRI

CÓD.	DESCRIÇÃO
6921	ENXADAO LARGO 2,5 LB SERVENTE



INDUSTRIA PEGARRI

CÓD.	DESCRIÇÃO
6909	ENXADAO LARGO 3,0 LB ALPE



INDUSTRIA PEGARRI

CÓD.	DESCRIÇÃO
6927	ENXADÃO ESTREITO 3,0 LB DUAS CARAS



INDUSTRIA PEGARRI

CÓD.	DESCRIÇÃO
6928	ENXADÃO LARGO 3,0 LB DUAS CARAS



CÓD. DESCRIÇÃO
6916 ENXADA ALPE MINI 15CM COM CABO



CÓD. DESCRIÇÃO
6915 ENXADA ALPE MINI 15CM SEM CABO



CÓD. DESCRIÇÃO
6924 ENXADA LARGA GOIVADA DUAS CARAS - 1,5 LB
6925 ENXADA LARGA GOIVADA DUAS CARAS - 2,0 LB
6926 ENXADA LARGA GOIVADA DUAS CARAS - 2,5 LB



CÓD. DESCRIÇÃO
8920 ENXADA LARGA 2.5 COM CABO DE 1,5M



CÓD. DESCRIÇÃO
6910 ENXADA LARGA GOIVADA NOVA ALPE - 1,5 LB
6911 ENXADA LARGA GOIVADA NOVA ALPE - 2,0 LB
6912 ENXADA LARGA GOIVADA NOVA ALPE - 2,5 LB
6913 ENXADA LARGA GOIVADA NOVA ALPE - 3,0 LB



CÓD. DESCRIÇÃO
6904 ENXADA LARGA GOIVADA ALPE 1,5 LB
6905 ENXADA LARGA GOIVADA ALPE 2,0 LB
6906 ENXADA LARGA GOIVADA ALPE 2,5 LB
6907 ENXADA LARGA GOIVADA ALPE 3,0 LB



CÓD. DESCRIÇÃO
6923 ENXADA ESTREITA GOIVADA 2,5 LB DUAS CARAS
6914 ENXADA ESTREITA GOIVADA 2,5 LB NOVA ALPE



CÓD. DESCRIÇÃO
6920 ENXADA LARGA GOIVADA 2,5 LB SERVENTE



CÓD. DESCRIÇÃO
7029 ENXADA VALERIA 3,0 ALPE



CÓD. DESCRIÇÃO
6919 ENXADA ESTREITA 2,5 LB SERVENTE



CÓD. DESCRIÇÃO
6903 ENXADA ESTREITA GOIVADA 2,5 LB ALPE



CÓD. DESCRIÇÃO
6819 ENXADA MINI S/ CABO 150X150



CÓD. DESCRIÇÃO
4640 ENXADA LARGA 2,5 LB S/CABO GOIVADA



CÓD. DESCRIÇÃO
6918 RODO TERREIRO 45 CM ALPE



CÓD. DESCRIÇÃO
6917 RODO CURRAL 2,5 LB ALPE



ULTRA

CÓD.	DESCRIÇÃO
3009	MANGUEIRA 100 MT JARD. LARANJA 1/2X2 SILIC.
308643	MANGUEIRA 100 MT JARD. AMARELA 1/2X2 SILIC.
431530	MANGUEIRA 200 MT JARD. LARANJA 1/2 SILIC.
301230	MANGUEIRA 200 MT JARD. AMARELA 1/2 SILIC.
301030	MANGUEIRA 300 MT JARD. LARANJA 1/2X2 SILIC.
3011	MANGUEIRA 300 MT JARD. AMARELA 1/2X2 SILIC.



TRAMONTINA

CÓD.	DESCRIÇÃO
6630	MANGUEIRA 100 MT JARD VERDE 1/2X2.3 SIL
663166	MANGUEIRA 200 MT JARD VERDE 1/2X2.3 SIL
6632	MANGUEIRA 300 MT JARD VERDE 1/2X2.3 SIL



Mantac
Tecnologia em Mangueiras, Tórcas e Reservas

CÓD.	DESCRIÇÃO
6163	MANGUEIRA CONJ. JARDIM TRANC. VERDE 10M
61646165	MANGUEIRA CONJ. JARDIM TRANC. VERDE 15M
6165	MANGUEIRA CONJ. JARDIM TRANC. VERDE 20M



ULTRA

CÓD.	DESCRIÇÃO
7787	MANGUEIRA PT-300 100M AR/ÁGUA PRETA 1/2X3,3
7788	MANGUEIRA PT-300 50M AR/ÁGUA PRETA 1/2X3,3



FAMA MANGUEIRAS

CÓD.	DESCRIÇÃO
7628	MANGUEIRA FAMA PLUS 200 MT VERDE 1/2X2.0 SIL
7629	MANGUEIRA FAMA PLUS 300 MT VERDE 1/2X2.0 SIL
7630	MANGUEIRA FAMA PLUS 100 MT VERDE 1/2X2.0 SIL



RODADO FORCE

CÓD.	DESCRIÇÃO
5685	MANGUEIRA FORCELIN 100 MT PT-300 PRETA AGUA/AR 1



DTG

CÓD.	DESCRIÇÃO
5771	MANG POLIETILENO PRETA 1/2 X 1.5MM 100MT
5772	MANG POLIETILENO PRETA 3/4 X 2.0MM 100MT
5773	MANG POLIETILENO PRETA 1 X 2.0MM 100MT



UNIFORTE

CÓD.	DESCRIÇÃO
7725	MANGUEIRA CRISTAL NÍVEL 5/16 SILIC. 50M



COMETALUX

CÓD.	DESCRIÇÃO
1535	MANG. CHUVEIRO 5/16 X 1 BRANCA ROLO 50 M



TRAMONTINA

CÓD.	DESCRIÇÃO
6628	MANGUEIRA CRISTAL NÍVEL 5/16 SILIC. 50M



FAMA MANGUEIRAS

CÓD.	DESCRIÇÃO
7349	MANGUEIRA CRISTAL NÍVEL 5/16 SILIC. 50M



Blukit

CÓD.	DESCRIÇÃO
5785	MANG. SAIDA DE MAQUINA EXTENSIVA 2.20M



Blukit

CÓD.	DESCRIÇÃO
3717	MANGUEIRA ENTRADA DE MAQUINA DE LAVAR

















Mantac

CÓD.	DESCRIÇÃO
6171	MANGUEIRA ENTRADA DE TANQUINHO 1.20M



FAMA MANGUEIRAS

CÓD.	DESCRIÇÃO
7724	MANGUEIRA ENTRADA MAQUINA LAVAR 1.40M

 <p>Mantac</p>	 <p>VALEPLAST</p>	 <p>UNIFORTE</p>
<p>CÓD. 6172</p> <p>DESCRIÇÃO MANGUEIRA SAÍDA DE TANQUINHO 1,10M</p>	<p>CÓD. 7869</p> <p>DESCRIÇÃO MANGUEIRA SAÍDA TANQUINHO 1,10M CZ</p>	<p>CÓD. 7723</p> <p>DESCRIÇÃO MANGUEIRA GÁS TRANCADA CRISTAL 1.20MM</p>
 <p>Mantac</p>	 <p>UNIFORTE</p>	 <p>TRAMONTINA</p>
<p>CÓD. 6170</p> <p>DESCRIÇÃO MANGUEIRA GAS TRANCADA CRISTAL 1.20M</p>	<p>CÓD. 7827</p> <p>DESCRIÇÃO MANGUEIRA GÁS MULTI CRISTAL 3/8X3.0X50M</p>	<p>CÓD. 6629</p> <p>DESCRIÇÃO MANGUEIRA GAS MULTI CRISTAL 3/8X3.0X50M</p>
 <p>FAMA MANGUEIRAS</p>	 <p>Garden</p>	 <p>TRAMONTINA</p>
<p>CÓD. 7627</p> <p>DESCRIÇÃO MANGUEIRA PT-300 PRETA 200 MT 1/2 ÁGUA</p> <p>7689 MANGUEIRA PT-300 PRETA 100 MT 1/2 ÁGUA</p> <p>7690 MANGUEIRA PT-300 PRETA 300 MT 1/2 ÁGUA</p> <p>7789 MANGUEIRA PT-300 PRETA 50 MT 1/2 ÁGUA</p>	<p>CÓD. 2772</p> <p>DESCRIÇÃO ESGUICHO JET 1/2"</p>	<p>CÓD. 4665</p> <p>DESCRIÇÃO ESGUICHO RETO 1/2 P/ENG RAP PLAST</p> <p>4666 ESGUICHO RETO 1/2 P/ENG ROS. PLAST</p>
 <p>Garden</p>	 <p>Garden</p>	 <p>Garden</p>
<p>CÓD. 2773</p> <p>DESCRIÇÃO ESGUICHO TIPO MIGNON 1/2"</p>	<p>CÓD. 7775</p> <p>DESCRIÇÃO ESGUICHO TIPO ECLIPSE 1/2</p>	<p>CÓD. 5177</p> <p>DESCRIÇÃO PISTOLA DE PULVERIZAÇÃO 1/4"</p>
 <p>Garden</p>	 <p>ATLAS</p>	 <p>Garden</p>
<p>CÓD. 5176</p> <p>DESCRIÇÃO PISTOLA DE LIMPEZA 1/4"</p>	<p>CÓD. 5364</p> <p>DESCRIÇÃO ESGUICHO KIT 4 PECAS PLASTICO AZUL</p>	<p>CÓD. 2774</p> <p>DESCRIÇÃO ESGUICHO REVOLVER 1/2" TRADICIONAL PRATA</p> <p>2775 ESGUICHO REVOLVER 3/4" TRADICIONAL PRATA</p>

AGROPECUÁRIA



Garden

CÓD. DESCRIÇÃO
8938 ESGUICHO REV. TRADICIONAL P/ ENGATE RAP. PRATA



Garden

CÓD. DESCRIÇÃO
8939 ESGUICHO REVOLVER PLÁSTICO C/ PINO P/ ENGATE



Garden

CÓD. DESCRIÇÃO
2776 ESGUICHO REVOLVER 1/2 PLÁSTICO



Garden

CÓD. DESCRIÇÃO
8940 KIT ESGUICHO REV. PLAST. C/ 2 ENGATES RAP. PRATA



Garden

CÓD. DESCRIÇÃO
8937 ESGUICHO RETO PLÁSTICO PARA ENGATE RÁPIDO



Garden

CÓD. DESCRIÇÃO
8941 KIT ESGUICHO RETO PLAST. C/ 2 ENGATES RAP+BICO



BOMVINK

CÓD. DESCRIÇÃO
8270 ESGUICHO ALTA PRESSÃO 3 EM 1



TRAMONTINA

CÓD. DESCRIÇÃO
7920 ESGUICHO RETO 1/2 P/ENG RAP PLÁSTICO



TRAMONTINA

CÓD. DESCRIÇÃO
7943 ADAPTADOR 3/4 E 1/2 ROSQUEADO



TRAMONTINA

CÓD. DESCRIÇÃO
6685 ADAPTADOR 3/4 E 1/2 ROSQUEADO



TRAMONTINA

CÓD. DESCRIÇÃO
7998 UNIÃO MANGUEIRA 1/2



TRAMONTINA

CÓD. DESCRIÇÃO
4667 UNIAO MANGUEIRA 1/2



TRAMONTINA

CÓD. DESCRIÇÃO
7916 ADAPTADOR 3/4 E 1/2 ROSQUEADO



TRAMONTINA

CÓD. DESCRIÇÃO
4668 ADAPTADOR FEMEA 3/4 E 1/2 ROSQUEADO



TRAMONTINA

CÓD. DESCRIÇÃO
7937 ENGATE RÁPIDO 1/2 PARA MANGUEIRA



TRAMONTINA

CÓD. DESCRIÇÃO
4669 ENGATE RÁPIDO 1/2 PARA MANGUEIRA



UNIFORTE

CÓD. DESCRIÇÃO
7906 ADAPTADOR 3/4 E 1/2



REBOUÇAS

CÓD. DESCRIÇÃO
9019 ADAPTADOR C/ ROSCA INTERNA 1/2 AD59N
9020 ADAPTADOR C/ ROSCA INTERNA 3/4 AD60N



Garden

CÓD. DESCRIÇÃO
2779 BICO TORNEIRA ZAMAC 1/2 X 1/2
27802781 BICO TORNEIRA ZAMAC 3/4 X 1/2
2781 BICO TORNEIRA ZAMAC 3/4 X 3/4



Garden

CÓD. DESCRIÇÃO
6735 EMENDA MANGUEIRA 1/2 METAL GARDEN



ATLAS

CÓD. DESCRIÇÃO
3974 IRRIGADOR GIRATÓRIO RAP PLAST AZ PR6814



BOMVINK

CÓD. DESCRIÇÃO
8364 IRRIGADOR GIRATÓRIO ASPERSÃO



Garden

CÓD. DESCRIÇÃO
5178 IRRIGADOR GIRATÓRIO 1/2" 2 HASTES ALUMÍNIO



UNIFORTE

CÓD. DESCRIÇÃO
7905 SUPORTE PARA MANGUEIRA PVC



TRAMONTINA

CÓD. DESCRIÇÃO
4670 SUP. PARA MANGUEIRA PVC ATÉ 35 MT



THOMPSON

CÓD. DESCRIÇÃO
8095 PULVERIZADOR 500ML MANUAL



ATLAS

CÓD. DESCRIÇÃO
5359 PULVERIZADOR 580ML PLÁSTICO AZUL



TRAMONTINA

CÓD. DESCRIÇÃO
7150 PULVERIZADOR COSTAL 12L
7151 PULVERIZADOR COSTAL 20L



TRAMONTINA

CÓD. DESCRIÇÃO
7152 PULVERIZADOR COMPRESSÃO PREVIA 2L



Titanium

CÓD. DESCRIÇÃO
8801 PULVERIZADOR COMPRESSÃO PREVIA 2L



Bestfer

CÓD. DESCRIÇÃO
7559 PULVERIZADOR MANUAL DE PLÁSTICO 350ML



CÓD. DESCRIÇÃO
1313 REGADOR PLAST 10 L AZUL UNIV.
13144751 REGADOR PLAST 10 L VERDE UNIV.
47514752 REGADOR PLAST 10 L VERMELHO UNIV.
4752 REGADOR PLAST 10 L PRETO UNIV.



ATLAS
PRELIMINAR

CÓD. DESCRIÇÃO
5358 REGADOR 7L PLASTICO CINZA PRIMA FER



TRAMONTINA

CÓD. DESCRIÇÃO
4625 VASSOURA METALICA 22D C/CABO
46714672 VASSOURA PLAST 22D C/CABO LARANJ
4672 VASSOURA PLAST 18D C/CABO PRETA



THOMPSON

CÓD. DESCRIÇÃO
1948 VASSOURA 22D C/ CABO



MAX
FERRAMENTAS

CÓD. DESCRIÇÃO
8930 VASSOURA JARDIM METÁLICA REG 22D C/ CABO



BOMVINK

CÓD. DESCRIÇÃO
8139 CORRENTE PLÁSTICA 10 METROS 6MM



CÓD. DESCRIÇÃO
4061 CORRENTE PLÁSTICA 8MM PRETA (10 METROS)



THOMPSON

CÓD. DESCRIÇÃO
5844 CORRENTE GALVANIZADA 3,0MM 12,5KG
58455846 CORRENTE GALVANIZADA 3,5MM 12,5KG
58465848 CORRENTE GALVANIZADA 4,0MM 12,5KG
58475848 CORRENTE GALVANIZADA 4,5MM 12,5KG
58485848 CORRENTE GALVANIZADA 5,0MM 25KG
58495850 CORRENTE GALVANIZADA 5,5MM 25KG
58505850 CORRENTE GALVANIZADA 6,0MM 25KG
58515852 CORRENTE GALVANIZADA 6,5MM 25KG
58525856 CORRENTE GALVANIZADA 8,0MM 25KG
58535856 CORRENTE GALVANIZADA 9,5MM 25KG
5854 CORRENTE GALVANIZADA 12,0MM 25KG



ROBUSFER
ULTRA

CÓD. DESCRIÇÃO
6664 ARAME FARPADO 100M ULTRA 1,6MM
6665 ARAME FARPADO 250M ULTRA 1,6MM
6666 ARAME FARPADO 500M ULTRA 1,6MM



GO GERDAU

CÓD. DESCRIÇÃO
8099 ARAME FARPADO 500M GIR 1,6MM
8540 ARAME FARPADO 100M GIR 1,6MM
8672 ARAME FARPADO 250M GIR 1.6MM



Comep

CÓD. DESCRIÇÃO
6761 ARAME FARPADO 500M RAPTOR 1,6MM



GO GERDAU

CÓD. DESCRIÇÃO
7249 ARAME FARPADO 400M 2,2MM



CAÇULA

CÓD. DESCRIÇÃO
8504 CATRACA PARA CERCA ARAME LISO



CAÇULA

CÓD. DESCRIÇÃO
8505 ARGOLA PARA LAÇO

AGROPECUÁRIA



CAÇULA

CÓD.	DESCRIÇÃO
8506	MAÇARICO LANÇA CHAMAS A GÁS C/ MANG. 1M
8507	MAÇARICO LANÇA CHAMAS A GÁS C/ MANG. 2M



BOMVINK

CÓD.	DESCRIÇÃO
8488	CORDA ELÁSTICA PARA BAGAGEIRO



Bestfer

CÓD.	DESCRIÇÃO
7632	CINTA E CATRACA 1 PC. 200KG 2.5CM X 4.5M
7633	CINTA E CATRACA 2 PC. 200KG 2.5CM X 4.5M



Starrett

CÓD.	DESCRIÇÃO
4991	LIMA ENXADA STARRETT 08 L411-208



THOMPSON

CÓD.	DESCRIÇÃO
1813	LIMA THOMPSON C ENXADA 08
1814	LIMA D TRIÂNGULO/SERROTE 04



CÓD.	DESCRIÇÃO
6938	LIMA PARA ENXADA 8 POL. DUAS CARAS C/ CABO
6937	LIMA PARA ENXADA 8 POL. DUAS CARAS S/ CABO



ALPE

CÓD.	DESCRIÇÃO
7712	LIMA ENXADA COM CABO



CÓD.	DESCRIÇÃO
6940	LÂMINA PARA ROÇADEIRA 350 X 1,6 FURO 1 POL
6939	LÂMINA PARA ROÇADEIRA 350 X 1,6 FURO 20 MM



ULTRA

CÓD.	DESCRIÇÃO
7226	LAMINA P/ ROÇADEIRA 350 FURO 1" (25,4MM)
7036	LAMINA P/ ROÇADEIRA 350 FURO 20MM



THOMPSON

CÓD.	DESCRIÇÃO
1800	LÂMINA P/ ROÇADEIRA HÉLICE



THOMPSON

CÓD.	DESCRIÇÃO
3362	FACAO MATO 10" CABO PLASTICO
33633364	FACAO MATO 12" CABO PLASTICO
33642398	FACAO MATO 14" CABO PLASTICO
23982399	FACAO MATO 16" CABO PLASTICO
23992400	FACAO MATO 18" CABO PLASTICO
2400	FACAO MATO 20" CABO PLASTICO



CÓD.	DESCRIÇÃO
6930	FACÃO MATO CABO PLÁSTICO DUAS CARAS 10"
69316931	FACÃO MATO CABO PLÁSTICO DUAS CARAS 12"
69326932	FACÃO MATO CABO PLÁSTICO DUAS CARAS 14"
69336933	FACÃO MATO CABO PLÁSTICO DUAS CARAS 16"
69346934	FACÃO MATO CABO PLÁSTICO DUAS CARAS 18"
69356935	FACÃO MATO CABO PLÁSTICO DUAS CARAS 20"
6936	FACÃO MATO CABO PLÁSTICO DUAS CARAS 22"



ULTRA
TELAS

CÓD.	DESCRIÇÃO
8519	TELA VIVEIRO 1,00M X 50M FIO 24
8513	TELA VIVEIRO 1,50M X 50M FIO 26



ULTRA
TELAS

CÓD.	DESCRIÇÃO
8521	TELA GALINHEIRO 1,50M X 50M FIO 22
8514	TELA GALINHEIRO 1,50M X 50M FIO 23
8919	TELA GALINHEIRO 1,50M X 50M FIO 18



ULTRA
TELAS

CÓD.	DESCRIÇÃO
8515	TELA PINTEIRO 1,50M X 50M FIO 22
8518	TELA PINTEIRO 1,50M X 50M FIO 24



ULTRA
TELAS

CÓD.	DESCRIÇÃO
8517	TELA MANGUEIRÃO 1,50M X 50M FIO 16
85168520	TELA MANGUEIRÃO 1,50M X 50M FIO 18
8520	TELA MANGUEIRÃO 1,80M X 50M FIO 16



ROBUSFER

CÓD.	DESCRIÇÃO
6751	TELA VIVEIRO 1,00M X 50M FIO 24
68076809	TELA VIVEIRO 1,00M X 50M FIO 26
68096753	TELA PINTEIRO 1,00 X 50M FIO 24
6753	TELA PINTEIRO 1,50 X 50M FIO 22



ROBUSFER

CÓD.	DESCRIÇÃO
6900	TELA MANGUEIRÃO 1,80M X 50M FIO 16
68996897	TELA MANGUEIRÃO 1,50M X 50M FIO 16
6897	TELA MANGUEIRÃO 1,00 X 50M FIO 16
6755	TELA GALINHEIRO 1,80M X 50M FIO 22
68056863	TELA GALINHEIRO 1,80M X 50M FIO 23
6863	TELA GALINHEIRO 1,50M X 50M FIO 18



Comep

CÓD.	DESCRIÇÃO
6752	TELA PINTEIRO 1,00M X 50M FIO 22 - TIPO 1
67536810	TELA PINTEIRO 1,50M X 50M FIO 22 - TIPO 1
6810	TELA PINTEIRO 1,50M X 50M FIO 24 TIPO 1



Comep

CÓD.	DESCRIÇÃO
6863	TELA GALINHEIRO 1,50M X 50M FIO 18 - TIPO 2
67546808	TELA GALINHEIRO 1,50M X 50M FIO 22 - TIPO 2
68047509	TELA GALINHEIRO 1,50M X 50M FIO 23 - TIPO 2
7509	TELA GALINHEIRO 1,80M X 50M FIO 18



Comep

CÓD.	DESCRIÇÃO
6751	TELA VIVEIRO 1,00M X 50M FIO 24 - TIPO 1/2
68076808	TELA VIVEIRO 1,00M X 50M FIO 26 - TIPO 1/2
6808	TELA VIVEIRO 1,50M X 50M FIO 26 - TIPO 1/2

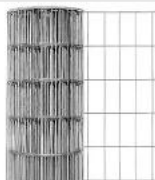

Comep

CÓD.	DESCRIÇÃO
7382	TELA SOLD. ALAMBRADO 1,20M X 25M FIO 1,9MM
7383	TELA SOLD. ALAMBRADO 1,50M X 25M FIO 1,9MM
7391	TELA SOLD. ALAMBRADO 1,80M X 25M FIO 1,9MM
7384	TELA SOLD. ALAMBRADO 1,20M X 25M FIO 2,3MM
7385	TELA SOLD. ALAMBRADO 1,50M X 25M FIO 2,3MM
7386	TELA SOLD. ALAMBRADO 1,80M X 25M FIO 2,3MM
7387	TELA SOLD. P/ REVEST. 0,50M X 25M FIO 1,24M
7388	TELA SOLD. P/ REVEST. 1,00M X 25M FIO 1,24M



Comep

CÓD.	DESCRIÇÃO
7730	TELA MOSQUITEIRO BRANCA 1,2M X 50M
7731	TELA MOSQUITEIRO VERDE 1,2M X 50M
7732	TELA MOSQUITEIRO BRANCA 1,5M X 50M
7733	TELA MOSQUITEIRO VERDE 1,5M X 50M
7734	TELA MOSQUITEIRO BRANCA 1,0M X 50M
7735	TELA MOSQUITEIRO VERDE 1,0M X 50M



ATLAS
MOSQUITO

CÓD.	DESCRIÇÃO
6539	TELA MOSQUITEIRO 1,25X1,65M POLIESTER BR



EMBATELAS

CÓD.	DESCRIÇÃO
8972	TELA MOSQUITEIRO BRANCA 1,0M X 50M
8973	TELA MOSQUITEIRO PRATA 1,0M X 50M
8974	TELA MOSQUITEIRO VERDE 1,0M X 50M
8975	TELA MOSQUITEIRO BRANCA 1,2M X 50M
8976	TELA MOSQUITEIRO PRATA 1,2M X 50M
8977	TELA MOSQUITEIRO VERDE 1,2M X 50M
8978	TELA MOSQUITEIRO BRANCA 1,5MX50M
8979	TELA MOSQUITEIRO PRATA 1,5MX50M
8980	TELA MOSQUITEIRO VERDE 1,5MX50M



ULTRA

CÓD.	DESCRIÇÃO
1065	CABO ENXADA CAIPIRA



Comep
JOMARCA
ULTRA

CÓD.	DESCRIÇÃO
4179	ARAME TORCIDO RECOZIDO 1KG N18
8721	ARAME TORCIDO RECOZIDO 1KG N18
4178	ARAME RECOZIDO 1KG BWG 14 LISO
3545	ARAME LISO RECOZIDO 1KG N18
3546	ARAME RECOZIDO 1KG BWG 16 LISO



GO
GERDAU

CÓD.	DESCRIÇÃO
7258	ARAME GALV 12 BWG 1KG GERDAU
7256	ARAME GALV 14 BWG 1KG GERDAU
7257	ARAME GALV 16 BWG 1KG GERDAU
7290	ARAME GALV 18 BWG 1KG GERDAU



GENERAL

CÓD.	DESCRIÇÃO
3551	ARAME GAL 16 BWG 1,65 MM ROLO COM 5M
3552	ARAME GAL 18 BWG 1,24 MM ROLO COM 5M
3548	ARAME GAL 22 BWG 0,71 MM ROLO COM 5M



ROBUSFER
ULTRA

CÓD.	DESCRIÇÃO
7374	ARAME GALV 12 BWG 1KG
8508	ARAME GALV 14 BWG 1KG
8509	ARAME GALV 16 BWG 1KG
8510	ARAME GALV 18 BWG 1KG
8511	ARAME GALV 20 BWG 1KG
7379	ARAME GALV 22 BWG 1KG



CÓD.	DESCRIÇÃO
7348	ARAME OVALADO 16X14 700KGF 1000M



CÓD.	DESCRIÇÃO
8512	ARAME OVALADO 16X14 - 700 KGF - 1000M



CÓD.	DESCRIÇÃO
7751	BOTINA DE ELÁSTICO N35 PRETA MOD 001
7752	BOTINA DE ELÁSTICO N36 PRETA MOD 001
7753	BOTINA DE ELÁSTICO N37 PRETA MOD 001
7271	BOTINA DE ELASTICO N38 PRETA MOD 001
7272	BOTINA DE ELASTICO N39 PRETA MOD 001
7273	BOTINA DE ELASTICO N40 PRETA MOD 001
7274	BOTINA DE ELÁSTICO N41 PRETA MOD 001
7275	BOTINA DE ELASTICO N42 PRETA MOD 001
7276	BOTINA DE ELASTICO N43 PRETA MOD 001
7277	BOTINA DE ELASTICO N44 PRETA MOD 001



CÓD.	DESCRIÇÃO
7278	BOTA PVC N38 PRETA MOD 203 CRIVAL
7279	BOTA PVC N39 PRETA MOD 203 CRIVAL
7280	BOTA PVC N40 PRETA MOD 203 CRIVAL
7281	BOTA PVC N41 PRETA MOD 203 CRIVAL
7282	BOTA PVC N42 PRETA MOD 203 CRIVAL
7283	BOTA PVC N43 PRETA MOD 203 CRIVAL
7284	BOTA PVC N44/45 PRETA MOD 203 CRIVAL



CÓD.	DESCRIÇÃO
7992	BOTA PVC N35/36 PRETA MOD 203
7993	BOTA PVC N37 PRETA MOD 203



CÓD.	DESCRIÇÃO
7830	DOBRADIÇA PORTEIRA N.00 PINTADA
7831	DOBRADIÇA PORTEIRA N.01 PINTADA
7832	DOBRADIÇA PORTEIRA N.02 PINTADA
7833	DOBRADIÇA PORTEIRA N.03 PINTADA
7834	DOBRADIÇA PORTEIRA N.04 PINTADA



CÓD.	DESCRIÇÃO
1010	DOBRADIÇA PORTEIRA C.00
10111012	DOBRADIÇA PORTEIRA C.01
10121013	DOBRADIÇA PORTEIRA C.02
10132699	DOBRADIÇA PORTEIRA C.03
26993018	DOBRADIÇA PORTEIRA C.04
30183019	DOBRADIÇA PORTEIRA C.06
3019	DOBRADIÇA PORTEIRA C.08



CÓD.	DESCRIÇÃO
7153	TRANCA FERROLHO



CÓD.	DESCRIÇÃO
1339	TRANCA PORTEIRA



CÓD.	DESCRIÇÃO
7835	TRANCA PORTEIRA 300 MM



CÓD.	DESCRIÇÃO
7597	TELHA COLONIAL PLAN PVC 2.42 X 0.88
7925	CUMEEIRA CENTRAL ART PLAN PVC TERRACOTA
7596	KIT VEDAÇÃO FIX COLONIAL 20UN.



CÓD.	DESCRIÇÃO
1726	TELHA TRANSLUCIDA 1,53 x 1,10 - AFORT
17251723	TELHA TRANSLUCIDA 1,83 x 1,10 - AFORT
17231724	TELHA TRANSLUCIDA 2,44 x 0,50 - AFORT
1724	TELHA TRANSLUCIDA 2,44 x 1,10 - AFORT



CÓD.	DESCRIÇÃO
3396	CORDA CARRETEL COLORIDO 14MM - 70 M
33913389	CORDA CARRETEL COLORIDO 05MM - 155 M
3389	CORDA CARRETEL COLORIDO 03MM - 400 M



CÓD.	DESCRIÇÃO
7401	CORDA PP 03MM MULTICOR TROPICAL 25M TR.
7402	CORDA PP 04MM MULTICOR TROPICAL 360M TR.
7403	CORDA PP 05MM MULTICOR TROPICAL 250M TR.
7404	CORDA PP 06MM MULTICOR TROPICAL 165M TR.
7405	CORDA PP 08MM MULTICOR TROPICAL 258M TR.
7406	CORDA PP 10MM MULTICOR TROPICAL 190M TR.
7407	CORDA PP 12MM MULTICOR TROPICAL 140M TR.
7411	CORDA PP 14MM MULTICOR TROPICAL 110M TR.

AGROPECUÁRIA



CÓD.	DESCRIÇÃO
8435	TELHA COLONIAL PLAN PVC 2.42 X 0.88
8434	CUMEEIRA CENTRAL ARTIC PLAN PVC MARFIM
8433	KIT VEDAÇÃO FIX COLONIAL 20UN.

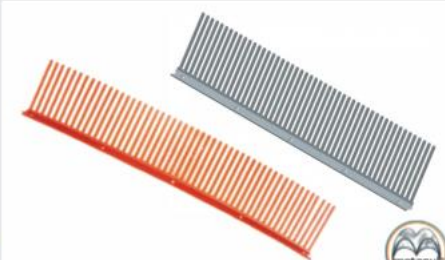

CÓD.	DESCRIÇÃO
1311	PASSARINHEIRA PLAST UNIVERSAL CERAMICA
1312	PASSARINHEIRA PLAST UNIVERSAL CINZA



CÓD.	DESCRIÇÃO
3294	ROLDANA N10
32953296	ROLDANA N12
32963297	ROLDANA N14
32974150	ROLDANA N16
41505080	ROLDANA N18
5080	ROLDANA N20



CÓD.	DESCRIÇÃO
4593	TORRADOR DE CAFÉ Nº 4 CAP. 4L

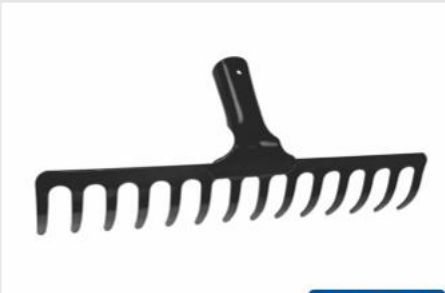

CÓD.	DESCRIÇÃO
4645	ANCINHO METÁLICO 14 DENTES S/CABO



CÓD.	DESCRIÇÃO
4649	COLHEDOR DE FRUTAS MÉDIO



CÓD.	DESCRIÇÃO
4901	CUPINICIDA 900 ML EXTERMINADOR DE CUPINS



CÓD.	DESCRIÇÃO
8289	EXTERMINADOR DE CUPIM 900ML
8290	EXTERMINADOR DE CUPIM 400ML



CÓD.	DESCRIÇÃO
7367	RATOEIRA ADESIVA COLA RATO C/AROMA DE AMENDOIM 22



CÓD.	DESCRIÇÃO
6878	CLORO ATCLLORO 3 EM 1 10 KG
6877	CLORO 3 EM 1 ATCLLORO 1KG



CÓD.	DESCRIÇÃO
6722	TABLETE 3 EM 1 MULTIPLA ACAA 200 G



CÓD.	DESCRIÇÃO
7442	TABLETE PASTILHA 200G ULTRA CLOR



CÓD.	DESCRIÇÃO
6728	ALGICIDA DE MANUTENCAO 1 L



CÓD.	DESCRIÇÃO
6879	ESTABILIZANTE DE PH ATPH ESTAVEL 2KG



CÓD.	DESCRIÇÃO
6723	TABLETE GENCLOR 200G T-200 GENCO



GENCO

CÓD. DESCRIÇÃO
8600 ELEVADOR DE PH LIQUIDO 1L PH MAIS
8599 REDUTOR DE PH ALCALINO 1L PH MENOS



GENCO

CÓD. DESCRIÇÃO
6726 CLORO 3 EM 1 MULTIPLA ACAA 1 KG



GENCO

CÓD. DESCRIÇÃO
6725 CLORO 3 EM 1 MULTIPLA ACAA 2,5KG
6724 CLORO 3 EM 1 MULTIPLA ACAA 10KG



GENCO

CÓD. DESCRIÇÃO
8653 CLORO ESTABILIZADOR GENCLOR 10KG



ULTRACLOR

CÓD. DESCRIÇÃO
7443 ALGICIDA DE MANUTENCAO 1L



Atcllor

CÓD. DESCRIÇÃO
6875 ALGICIDA DE MANUTENCAO 1 LT



Atcllor

CÓD. DESCRIÇÃO
6872 LIMPA BORDA 1LT



Atcllor

CÓD. DESCRIÇÃO
6873 ALGICIDA DE CHOQUE 1 LT



Atcllor

CÓD. DESCRIÇÃO
6874 CLARIFICANTE FLOC 1 LT



Atcllor

CÓD. DESCRIÇÃO
6876 ALGICIDA DE METAIS 1LT



ULTRACLOR

CÓD. DESCRIÇÃO
7446 SULFATO DE ALUMINIO DECANTADOR 2KG



Atcllor

CÓD. DESCRIÇÃO
6881 SULFATO DE ALUMINIO DECANTADOR ATSULF 2KG



GENCO

CÓD. DESCRIÇÃO
6727 CLARIFICANTE GENFLOC 1 L



GENCO

CÓD. DESCRIÇÃO
6730 BARRILHA 2KG



Atcllor

CÓD. DESCRIÇÃO
6880 BARRILHA ATCLLOR ATPH+ 2KG

AGROPECUÁRIA



ULTRACLOR

CÓD. 7444 DESCRIÇÃO ALGICIDA DE CHOQUE ULTRACLOR 1L



GENCO

CÓD. 6812 DESCRIÇÃO ESTABILIZANTE DE PH GENCO PH CERTO 2KG



GENCO

CÓD. 6731 DESCRIÇÃO SULFATO DE ALUMÍNIO DECAN- TADOR CLARIFIC 2KG



GENCO

CÓD. 6811 DESCRIÇÃO ALGICIDA DE CHOQUE - 1L



BRÜSTEC

CÓD. 8531 DESCRIÇÃO ASPIRADOR 8 RODAS



ATclor

CÓD. 6870 DESCRIÇÃO ASPIRADOR ASA DELTA



BRÜSTEC

CÓD. 8538 DESCRIÇÃO CABO ALUMÍNIO P/ LIMPEZA PISCINA 3M TELESC.
8539 CABO ALUMÍNIO P/ LIMPEZA PISCINA 4M TELESC.



BRÜSTEC

CÓD. 8535 DESCRIÇÃO CLORADOR FLUTUADOR MARG. GRANDE
8534 CLORADOR FLUTUADOR MARG. MÉDIO



BRÜSTEC

CÓD. 8532 DESCRIÇÃO ESCOVA DE PISCINA NYLON CURVA 45 CM



BRÜSTEC

CÓD. 8533 DESCRIÇÃO ESCOVA PISCINA NYLON RETA 30 CM



BRÜSTEC

CÓD. 8536 DESCRIÇÃO PENEIRA PISCINA COM PA METÁLICA
8537 PENEIRA PISCINA COM PA PLÁSTICA



BOMVINK

CÓD. 8487 DESCRIÇÃO APARELHO MEDIDOR DE PH DIGITAL



ATclor

CÓD. 6884 DESCRIÇÃO ESTOJO ANÁLISE 4 EM 1



GENCO

CÓD. 6732 DESCRIÇÃO ESTOJO DE ANÁLISES CLORO/PH



GENCO

CÓD. 6733 DESCRIÇÃO REAGENTE DE CLORO OT 23 ML



CÓD.	DESCRIÇÃO
6885	REAGENTE DE CLORO 23ML



CÓD.	DESCRIÇÃO
6886	REAGENTE DE PH 23 ML



CÓD.	DESCRIÇÃO
6734	REAGENTE DE PH 23 ML



CINZA CLARO



CÓD.	DESCRIÇÃO
8525	GARRAFA TÉRMICA 4L PRETA
8526	GARRAFA TÉRMICA 4L VERMELHA
8523	GARRAFA TÉRMICA 4L CINZA CLARO



CÓD.	DESCRIÇÃO
8527	GARRAFA TÉRMICA 1L PRETA
8528	GARRAFA TÉRMICA 1L AZUL
8529	GARRAFA TÉRMICA 1L CINZA



CÓD.	DESCRIÇÃO
5758	GARRAFAO TÉRMICO 4L COM TORNEIRA - AZUL
5759	GARRAFAO TÉRMICO 4L COM TORNEIRA - VERM.
5760	GARRAFAO TÉRMICO 8L COM TORNEIRA - AZUL
5762	GARRAFAO TÉRMICO 12L COM TORNEIRA - AZUL



CÓD.	DESCRIÇÃO
8522	GARRAFAO TÉRMICO OASIS 5L PRETO
8523	GARRAFAO TÉRMICO OASIS 5L AZUL
8524	GARRAFAO TÉRMICO OASIS 5L VERMELHO



CÓD.	DESCRIÇÃO
8606	LONA 4X100 PRETA 28 MICRAS C/ 10KG RB
8607	LONA 4X100 PRETA 41 MICRAS C/ 15KG RB
8608	LONA 4X100 PRETA 68 MICRAS C/ 25KG RB
8609	LONA 4X100 PRETA 97 MICRAS C/ 35KG RB
8610	LONA 6X100 PRETA 33 MICRAS C/ 18KG RB
8611	LONA 6X100 PRETA 55 MICRAS C/ 30KG RB
8612	LONA 6X100 PRETA 74 MICRAS C/ 40KG RB
8613	LONA 8X100 PRETA 42 MICRAS C/ 30KG RB
8614	LONA 8X100 PRETA 62 MICRAS C/ 45KG RB



CÓD.	DESCRIÇÃO
6175	LONA PRETO BRANCO 8 X 50 - 40 KG - 150 MIC
6176	LONA PRETO BRANCO 6 X 100 - 60 KG - 150 MIC
6177	LONA PRETO BRANCO 4 X 100 - 40 KG - 150 MIC
6178	LONA PRETA 4 X 110 - 36 KG - 140 MIC
6179	LONA PRETA 6 X 100 - 54 KG - 100 MIC
6180	LONA PRETA 6 X 100 - 45 KG - 125 MIC
6181	LONA PRETA 8 X 100 - 72 KG - 100 MIC
6182	LONA PRETA 8 X 50 - 36 KG - 140 MIC



CÓD.	DESCRIÇÃO
1923	LONA 2X2 AZUL
1924	LONA 3X2 AZUL
1925	LONA 3X3 AZUL
1926	LONA 4X3 AZUL
1927	LONA 4X4 AZUL
1929	LONA 5X4 AZUL
1928	LONA 5X3 AZUL
1930	LONA 6X4 AZUL
1931	LONA 6X5 AZUL
1932	LONA 7X4 AZUL
5123	LONA AZUL 7X5
5124	LONA AZUL 7X6
5125	LONA AZUL 8X4
5126	LONA AZUL 8X5
5127	LONA AZUL 8X7
5128	LONA AZUL 10X8



CÓD.	DESCRIÇÃO
3420	LONA 4X100 PRETA 41 MICRAS C/ 15KG
3421	LONA 4X100 PRETA 68 MICRAS C/ 25KG
3422	LONA 6X100 PRETA 65 MICRAS C/ 36KG
3423	LONA 4X100 PRETA 101 MICRAS C/ 37KG
3424	LONA 6X100 PRETA 97 MICRAS C/ 54KG



CÓD.	DESCRIÇÃO
8601	LONA PRETA 2X4 COBREMMAIS RB
8602	LONA PRETA 3X4 COBREMMAIS RB
8603	LONA PRETA 4X4 COBREMMAIS RB
8604	LONA PRETA 5X4 COBREMMAIS RB
8605	LONA PRETA 6X4 COBREMMAIS RB



9005	LONA PRETA MAXILONA 4X100 13KG GRATIS 10M
9004	LONA PRETA MAXILONA 4X100 20KG GRATIS 10M
9003	LONA PRETA MAXILONA 4X100 30KG GRATIS 10M
9002	LONA PRETA MAXILONA 4X100 36KG GRATIS 10M
9001	LONA PRETA MAXILONA 4X100 40KG GRATIS 10M

9006	LONA PRETA MAXILONA 6X100 30KG GRATIS 10M
9007	LONA PRETA MAXILONA 6X100 51KG GRATIS 10M
9008	LONA PRETA MAXILONA 6X100 60KG GRATIS 10M
9009	LONA PRETA MAXILONA 8X100 70KG GRATIS 10M
9010	LONA PRETA MAXILONA 8X50 40KG GRATIS 10M



BOMVINK

CÓD.	DESCRIÇÃO
8130	FIO DE NYLON PARA ROÇADEIRA 2,4MMX15M



Canaã

CÓD.	DESCRIÇÃO
8724	CHURRASQUEIRA 40x25 CM



Comep

CÓD.	DESCRIÇÃO
6764	PENEIRA CAFE PLAST. 55MM
6806	PENEIRA FEIJAO 55MM PRETA
6763	PENEIRA ARROZ PLAST. 55MM
6762	PENEIRA AREIA PLAST. 55MM
6765	PENEIRA CAL/FUBA PLAST. 55MM
6902	PENEIRA CAFE PLAST. 60MM
6901	PENEIRA CAL/FUBA 25MM



TELAS MM

CÓD.	DESCRIÇÃO
2694	PENEIRA AREIA PLAST. 55MM MM
2695	PENEIRA ARROZ PLAST. 55MM MM
2696	PENEIRA CAFE PLAST. 55MM MM
2698	PENEIRA FEIJAO PLAST. 55MM MM
2697	PENEIRA CAL/FUBA PLAST. 55MM MM



TELAS MM

CÓD.	DESCRIÇÃO
1221	PENEIRA AREIA (MADEIRA) 55 MM
1220	PENEIRA ARROZ (MADEIRA) 55 MM
1224	PENEIRA CAFE (MADEIRA) 55 MM
1222	PENEIRA CAL (MADEIRA) 55 MM
1223	PENEIRA FEIJAO (MADEIRA) 55 MM



MAX FERRAMENTAS

CÓD.	DESCRIÇÃO
8921	VASSOURÃO FIO RÍGIDO 40X45 COM CABO 1,2M



MAX FERRAMENTAS

CÓD.	DESCRIÇÃO
8922	VASSOURA DOMÉSTICA COM CABO PRETO 1,2M



MAX FERRAMENTAS

CÓD.	DESCRIÇÃO
8924	VASSOURA TIPO PIAÇAVA C/ CB PRETO 1,2 M



MAX FERRAMENTAS

CÓD.	DESCRIÇÃO
8923	ESCOVA OVAL MULTIUSO

ELÉTRICA

ULTRA
/// ATACADISTA

ULTRA

ELETRIK



**ELETRODUTO FLEXÍVEL
CORRUGADO CINZA**

999	20MM - 50M
998	25MM - 50M
1000	32MM - 25M



**7413 - CAIXINHA
DE LUZ 4X2
AMARELA
PRIME PVC**



**7414 - CAIXINHA
DE LUZ 4X4
AMARELA
PRIME PVC**



**7490 - PLAFON
BOCAL PORCELANA
BRANCO 100W 250V**

**SUPORTE PARA
LAJE AMARELO**

5169	25CM
5170	30CM



PRODUTOS COM
1 ANO DE GARANTIA
EM TODAS AS CATEGORIAS

SAIBA MAIS EM:



1
ANO
GARANTIA

- ◆ Construção civil
- ◆ Ferragens
- ◆ Ferramentas
- ◆ Acessórios e utilidades
- ◆ Elétrica
- ◆ Automotivo
- ◆ Hidráulica
- ◆ Jardim



THOMPSON



@thompsonferramentasoficial

THOMPSONFERRAMENTAS.COM.BR





ELÉTRICA

		
CÓD. 6427	CÓD. 6426	CÓD. 6425
DESCRIÇÃO PLACA 4X4 6MOD	DESCRIÇÃO PLACA 4X4 4MOD DISTR	DESCRIÇÃO PLACA 4X4 2MOD DISTR
		
CÓD. 6424	CÓD. 6423	CÓD. 6431
DESCRIÇÃO PLACA C/FURO 4X4	DESCRIÇÃO PLACA 4X4 CEGA	DESCRIÇÃO PLACA 4X2 2MOD DISTRIBUIDO
		
CÓD. 6428	CÓD. 6420	CÓD. 6429
DESCRIÇÃO PLACA 4X2 CEGA	DESCRIÇÃO PLACA C/FURO 4X2	DESCRIÇÃO PLACA 4X2 1 MOD VERTICAL
		
CÓD. 1289	CÓD. 1291	CÓD. 1154
DESCRIÇÃO PLACA 4X4 6 MOD PETRA	DESCRIÇÃO PLACA 4X4 2 MOD DISTR PETRA	DESCRIÇÃO PLACA CEGA 4X4 MILL
		
CÓD. 1287	CÓD. 1288	CÓD. 1290
DESCRIÇÃO PLACA 4X4 4 MOD DISTR PETRA	DESCRIÇÃO PLACA 4X4 4 MOD PETRA	DESCRIÇÃO PLACA 4X4 CEGA PETRA





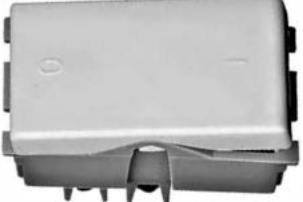









ELÉTRICA

		
TRAMONTINA	TRAMONTINA	TRAMONTINA
CÓD. DESCRIÇÃO 6430 PLACA 4X2 1MOD HORIZONTAL	CÓD. DESCRIÇÃO 6422 PLACA 4X2 3MOD	CÓD. DESCRIÇÃO 6421 PLACA 4X2 2MOD
		
		
CÓD. DESCRIÇÃO 1286 PLACA 4X2 3 MOD PETRA	CÓD. DESCRIÇÃO 1285 PLACA 4X2 2 MOD DISTR PETRA	CÓD. DESCRIÇÃO 1165 PLACA 4X2 1M MOD HORIZ PETRA
		
		
CÓD. DESCRIÇÃO 1166 PLACA 4X2 2 MOD PETRA	CÓD. DESCRIÇÃO 1164 PLACA 4X2 CEGA PETRA	CÓD. DESCRIÇÃO 1284 PLACA 4X2 1 MOD VERTI PETRA
		
		
CÓD. DESCRIÇÃO 2075 PLACA 3 SEÇÃO 4X2 MILLENIUM	CÓD. DESCRIÇÃO 2074 PLACA 2 SEÇÃO 4X2 MILLENIUM	CÓD. DESCRIÇÃO 2081 PLACA 4X2 MILL P/ 2 INT+TOM 14136 7475 PLACA 4X2 MILL P/2 INTERRUPTORES+1 TOM
		
		
CÓD. DESCRIÇÃO 2073 PLACA 1 SEÇÃO 4X2 MILLENIUM	CÓD. DESCRIÇÃO 2079 PLACA 4X2 MILL P/ 2 TOM NBR 14136	CÓD. DESCRIÇÃO 2078 PLACA 4X2 MILL P/ TOM. VERT. NBR 14136 2076 PLACA 1TOM 4X2 MILL















ELÉTRICA

		
<p>CÓD. DESCRIÇÃO 2077 PLACA 4X2 CZ P/ 1 TOM HORZ NBR 14136</p>	<p>CÓD. DESCRIÇÃO 1152 PLACA CEGA 4X2 MILL</p>	<p>CÓD. DESCRIÇÃO 2080 PLACA 4X2 MILL P/ 1 INT+TOM 14136</p>
		
<p>CÓD. DESCRIÇÃO 1153 PLACA C/FURO 4X2 MILL</p>	<p>CÓD. DESCRIÇÃO 3006 PLACA C/FURO RED 3" MILL 3008 PLACA C/FURO RED 4" MILL</p>	<p>CÓD. DESCRIÇÃO 3005 PLACA CEGA RED 3" MILL 3007 PLACA CEGA RED 4" MILL</p>
		
<p>CÓD. DESCRIÇÃO 3494 PLACA 2X2 SOB MILL P/01 INT+TOM NBR14136</p>	<p>CÓD. DESCRIÇÃO 6437 MODULO INTERRUPTOR SIMPLES</p>	<p>CÓD. DESCRIÇÃO 6434 MODULO INTERRUPTOR PARALELO</p>
		
<p>CÓD. DESCRIÇÃO 6436 MODULO INT BIPOLAR 10A SIMP</p>	<p>CÓD. DESCRIÇÃO 6435 MODULO INTERRUPTOR INTERMEDIARIO 10A</p>	<p>CÓD. DESCRIÇÃO 3302 MODULO INT INTERMEDIÁRIO 10A PETRA</p>
		
<p>CÓD. DESCRIÇÃO 1170 MOD INT BIP 10A SIMP PETRA</p>	<p>CÓD. DESCRIÇÃO 1171 MOD INT SIMP PETRAMOD INT P 1172 MOD INT PAR PETRA</p>	<p>CÓD. DESCRIÇÃO 1173 MODULO CAMPAINHA BIVOLT 110V-220V BCO 3000 MODULO PLUS CAMPAINHA PETRA</p>















ELÉTRICA

 <p style="text-align: right;">TRAMONTINA</p>	 <p style="text-align: right;">TRAMONTINA</p>	 <p style="text-align: right;">TRAMONTINA</p>
<p>CÓD. DESCRIÇÃO 6438 MODULO PULSADOR CAMPAINHA</p>	<p>CÓD. DESCRIÇÃO 6440 MODULO TOMADA 2P+T 10A/250V</p>	<p>CÓD. DESCRIÇÃO 6442 MODULO TOMADA 2P+T 20A/250V</p>
 <p style="text-align: right;">TRAMONTINA</p>	 <p style="text-align: right;">Mec-Tronic</p>	 <p style="text-align: right;">Mec-Tronic</p>
<p>CÓD. DESCRIÇÃO 6862 MODULO TOMADA VERMELHO 2P+T 20A/250V</p>	<p>CÓD. DESCRIÇÃO 1169 MOD 2P+T 10A/250V PETRA S/PL 1168 MOD 2P+T 20A/250V PETRA S/PL</p>	<p>CÓD. DESCRIÇÃO 2809 MOD T USB ENT 110V 220V 0,18A E SAÍ. PETRA</p>
 <p style="text-align: right;">TRAMONTINA</p>	 <p style="text-align: right;">Mec-Tronic</p>	 <p style="text-align: right;">TRAMONTINA</p>
<p>CÓD. DESCRIÇÃO 6446 MODULO ANTENA TV SAT COAXIAL DIRETA</p>	<p>CÓD. DESCRIÇÃO 2809 MOD T USB ENT 110V 220V 0,18A E SAÍ. PETRA</p>	<p>CÓD. DESCRIÇÃO 6448 MODULO PARA RJ 45 CAT 6 6447 MODULO TOMADA P/ TELEFONE RJ11</p>
 <p style="text-align: right;">Mec-Tronic</p>	 <p style="text-align: right;">Mec-Tronic</p>	 <p style="text-align: right;">Mec-Tronic</p>
<p>CÓD. DESCRIÇÃO 1174 MOD P/ RJ45 - MD02</p>	<p>CÓD. DESCRIÇÃO 1167 MOD FÊMEA TELEFONE AMER PETRA</p>	<p>CÓD. DESCRIÇÃO 6433 MODULO COM FURO</p>
 <p style="text-align: right;">Mec-Tronic</p>	 <p style="text-align: right;">Mec-Tronic</p>	 <p style="text-align: right;">TRAMONTINA</p>
<p>CÓD. DESCRIÇÃO 1445 MODULO COM FURO PETRA</p>	<p>CÓD. DESCRIÇÃO 3303 MODULO VISOR CEGO PETRA</p>	<p>CÓD. DESCRIÇÃO 6432 MODULO VISOR CEGO</p>















ELÉTRICA

 <p>Mec-Tronic</p> <p>CÓD. DESCRIÇÃO 1159 CONJ. PETRA 3 INT SIMP C/PL</p>	 <p>Mec-Tronic</p> <p>CÓD. DESCRIÇÃO 1138 CONJ. 3 INT C/PL MILL 13551358 CONJ INT SIMP+2INT PARL C/PL MILL 13581360 CONJ 2INT SIMP+INT PARL C/PL MILL 1360 CONJ 3 INT PARL C/PL MILL</p>	 <p>Mec-Tronic</p> <p>CÓD. DESCRIÇÃO 1157 CONJ PETRA 2 INT SIMP C/PL MILL 1158 CONJ PETRA INT SIMP+INT PARAL C/PL</p>
 <p>Mec-Tronic</p> <p>CÓD. DESCRIÇÃO 1136 CONJ. 2 INT SIMP C/PL MILL 11371356CONJ. INT SIMP+INT PARL C/PL MILL 1356 CONJ 2INT PARL C/PL MILL MEC TRONIC</p>	 <p>Mec-Tronic</p> <p>CÓD. DESCRIÇÃO 1155 CONJ PETRA INT SIMP C/PL HORZ 1156 CONJ PETRA INT PARL C/PL HORZ</p>	 <p>Mec-Tronic</p> <p>CÓD. DESCRIÇÃO 1135 CONJ. INT PARL C/PL MILL 1134 CONJ. INT SIMP C/PL MILL</p>
 <p>Mec-Tronic</p> <p>CÓD. DESCRIÇÃO 1139 CONJ. PULSADOR CAMPAINHA C/PL MILL</p>	 <p>Mec-Tronic</p> <p>CÓD. DESCRIÇÃO 1162 CONJ. PETRA 2 INT SP+TOM 2P+T C/ PL 4X2</p>	 <p>Mec-Tronic</p> <p>CÓD. DESCRIÇÃO 1161 CONJ PETRA INT S+TOM 2P+T 10A/250V C/PL</p>
 <p>Mec-Tronic</p> <p>CÓD. DESCRIÇÃO 1146 CONJ 2INT SIMP+TOM 2P+T 10A C/PL MILL 13521654 CONJ INT PAR+TOM 2P+T 10A/250V C/PL MILL 13541857 CONJ 1INT SIMP + 1PAR+ TOM 10A C/PL MILL 1357 CONJ 2INT PARAL+TOM 2P+T 10A C/PL MILL</p>	 <p>Mec-Tronic</p> <p>CÓD. DESCRIÇÃO 1145 CONJ INT SIMP 10A+TOM 2P+T 20A C/PL MILL 11441359 CONJ INT SIMP+TOM 2P+T 10A C/PL MILL 13536500 CONJ INT PARAL 10A+TOM 2P+T 20A C/PL MILL 6500 INT PARAL 10A+TOM 2P+T 20A S/PL</p>	 <p>TRAMONTINA</p> <p>CÓD. DESCRIÇÃO 6445 CONJ INT S+TOM 2P+T 10A/250V</p>
 <p>TRAMONTINA</p> <p>CÓD. DESCRIÇÃO 6439 CONJUNTO INTERRUPTOR SIMPLES C/PL VERTICAL</p>	 <p>Mec-Tronic</p> <p>CÓD. DESCRIÇÃO 1140 CONJ. INT BIPOLAR 25A C/PL MILL</p>	 <p>Mec-Tronic</p> <p>CÓD. DESCRIÇÃO 1422 CONJ TOM 2P+T 10A/250V C/PL VERT MILL 2806 CONJ TOM 2P+T 20A/250V C/PL VERT MILL</p>

ELÉTRICA

		
<p>CÓD. DESCRIÇÃO</p> <p>1141 CONJ. TOM 2P+T 10A/250 C/PL HORZ</p> <p>1142 CONJ. TOM 2P+T 20A/250 C/PL HORZ</p>	<p>CÓD. DESCRIÇÃO</p> <p>2808 CONJ TOM 2P+T 20A/250V C/PL VERT MILL</p>	<p>CÓD. DESCRIÇÃO</p> <p>1163 CONJ PETRA TOM 2P+T 10A/250V C/PL HORZ</p> <p>7476 CONJ PETRA TOM 2P+T 20A/250V HORZ C/PL</p>
		
<p>CÓD. DESCRIÇÃO</p> <p>1160 CONJ PETRA 2 TOM 2P+T 10A/250V C/PL 4X2</p>	<p>CÓD. DESCRIÇÃO</p> <p>1148 CONJ. TEL TELEB/AMER C/PL MILL</p>	<p>CÓD. DESCRIÇÃO</p> <p>1150 CONJ. RJ45 C/PLACA 4X2 MILL</p>
		
<p>CÓD. DESCRIÇÃO</p> <p>1143 CONJ. 2 TOM 2P+T 10A 250V C/PL MILL</p> <p>1359 CONJ. 2 TOM 2P+T 20A 250V C/PL MILL</p>	<p>CÓD. DESCRIÇÃO</p> <p>1147 CONJ. CONECTOR ANTENA C/PL 4X2 MILL</p>	<p>CÓD. DESCRIÇÃO</p> <p>6444 CONJ TOM 2P+T 20A/250V C/PL HORZ</p>
		
<p>CÓD. DESCRIÇÃO</p> <p>6443 CONJ TOM 2P+T 10A/250V C/PL HORZ</p>	<p>CÓD. DESCRIÇÃO</p> <p>1183 SIST X 2 ATOM 2P+T</p>	<p>CÓD. DESCRIÇÃO</p> <p>7675 SIST X 2 TOMADAS 2P+T 20A/250VCA</p>
		
<p>CÓD. DESCRIÇÃO</p> <p>1181 SIST X TOM 2P+T 10A/250V</p> <p>1182 SIST X TOM 2P+T 20A/250V</p>	<p>CÓD. DESCRIÇÃO</p> <p>1179 SIST X INT</p>	<p>CÓD. DESCRIÇÃO</p> <p>1177 INTERRUPTOR EXTERNO SIMPLES BRANCO</p> <p>7129 INTERRUPTOR EXTERNO PARALELO MEC TR.</p>

ELÉTRICA

 <p style="text-align: right;">TRAMONTINA</p>	 <p style="text-align: right;">TRAMONTINA</p>	 <p style="text-align: right;">TRAMONTINA</p>
<p>CÓD. DESCRIÇÃO</p> <p>8370 CONECTOR DE SAÍDA 1/2 CINZA 8371 CONECTOR DE SAÍDA 3/4 CINZA 8372 CONECTOR DE SAÍDA 1" CINZA</p>	<p>CÓD. DESCRIÇÃO</p> <p>8373 LUVA PARA ELETRODUTO 1/2 CINZA 8374 LUVA PARA ELETRODUTO 3/4 CINZA 8375 LUVA PARA ELETRODUTO 1" CINZA</p>	<p>CÓD. DESCRIÇÃO</p> <p>8376 COTOVELO 90º JANELA INSPEÇÃO 1/2 - CINZA 8377 COTOVELO 90º JANELA INSPEÇÃO 3/4 - CINZA</p>
 <p style="text-align: right;">TRAMONTINA</p>	 <p style="text-align: right;">TRAMONTINA</p>	 <p style="text-align: right;">TRAMONTINA</p>
<p>CÓD. DESCRIÇÃO</p> <p>8378 TAMPÃO PVC CONDULETE 3/4 8379 TAMPÃO PVC CONDULETE 1"</p>	<p>CÓD. DESCRIÇÃO</p> <p>8380 CAIXA DE SOBREPÔR X 3 POSTOS - CINZA</p>	<p>CÓD. DESCRIÇÃO</p> <p>8381 CAIXA DE SOBREPÔR X CEGA - CINZA</p>
 <p style="text-align: right;">TRAMONTINA</p>	 <p style="text-align: right;">TRAMONTINA</p>	 <p style="text-align: right;">TRAMONTINA</p>
<p>CÓD. DESCRIÇÃO</p> <p>8382 CONECTOR RETO ALUM FLEXOR COM ROSCA 3/4 8383 CONECTOR RETO ALUM FLEXOR COM ROSCA 1"</p>	<p>CÓD. DESCRIÇÃO</p> <p>8384 LUVA EMENDA ALUM FLEXOR 1/2 8385 LUVA EMENDA ALUM FLEXOR 3/4 8386 LUVA EMENDA ALUM FLEXOR 1" 8387 LUVA EMENDA ALUM FLEXOR 1" /1/2 8388 LUVA EMENDA ALUM FLEXOR 2"</p>	<p>CÓD. DESCRIÇÃO</p> <p>8394 TAMPA CONDULETE ALUM CEGA 1"</p>
 <p style="text-align: right;">TRAMONTINA</p>	 <p style="text-align: right;">TRAMONTINA</p>	 <p style="text-align: right;">TRAMONTINA</p>
<p>CÓD. DESCRIÇÃO</p> <p>8396 TAMPA CONDULETE ALUM. 1 MOD</p>	<p>CÓD. DESCRIÇÃO</p> <p>8397 TAMPA CONDULETE ALUM. 2 MOD. 1"</p>	<p>CÓD. DESCRIÇÃO</p> <p>8407 TAMPA CONDULETE ALUM. 1 MOD 1/2" 3/4"</p>
 <p style="text-align: right;">TRAMONTINA</p>	 <p style="text-align: right;">TRAMONTINA</p>	 <p style="text-align: right;">TRAMONTINA</p>
<p>CÓD. DESCRIÇÃO</p> <p>8399 CONDULETE ALUM. MULTIPL0 1. 1/2 " 8400 CONDULETE ALUM. MULTIPL0 2"</p>	<p>CÓD. DESCRIÇÃO</p> <p>8401 CONDULETE ALUM. MULTIPL0 1" 8402 CONDULETE ALUM. MULTIPL0 3/4</p>	<p>CÓD. DESCRIÇÃO</p> <p>8406 COTOVELO 90º 1" CINZA</p>

ELÉTRICA

 <p>TRAMONTINA</p> <p>CÓD. DESCRIÇÃO</p> <p>8398 TAMPA CONDULETE 3 POSTOS 1"</p>	 <p>TRAMONTINA</p> <p>CÓD. DESCRIÇÃO</p> <p>8403 ABRAÇADEIRA ELETRODUTO COM BUCHA 1/2 Cinza</p> <p>8404 ABRAÇADEIRA ELETRODUTO COM BUCHA 3/4 Cinza</p> <p>8405 ABRAÇADEIRA ELETRODUTO COM BUCHA 1" Cinza</p>	 <p>TRAMONTINA</p> <p>CÓD. DESCRIÇÃO</p> <p>8389 CONECTOR CONDULETE ALUM 3/4"X1/2"</p> <p>8390 CONECTOR CONDULETE ALUM 1"</p> <p>8391 CONECTOR CONDULETE ALUM 1.1/2"</p> <p>8392 CONECTOR CONDULETE ALUM 2"</p> <p>8393 CONECTOR CONDULETE ALUM 3/4"</p>
 <p>wetzel</p> <p>CÓD. DESCRIÇÃO</p> <p>8587 ABRAÇADEIRA PVC CINZA PARA ELETRODUTO 1/2"</p> <p>8588 ABRAÇADEIRA PVC CINZA PARA ELETRODUTO 3/4"</p> <p>8589 ABRAÇADEIRA PVC CINZA PARA ELETRODUTO 1"</p>	 <p>wetzel</p> <p>CÓD. DESCRIÇÃO</p> <p>8590 CURVA PVC CINZA 2 BOLSA 1/2" X 90º</p> <p>8591 CURVA PVC CINZA 2 BOLSA 3/4" X 90º</p> <p>8592 CURVA PVC CINZA 2 BOLSA 1" X 90º</p>	 <p>wetzel</p> <p>CÓD. DESCRIÇÃO</p> <p>8584 ELETRODUTO RÍGIDO PVC CINZA 1/2"</p> <p>8585 ELETRODUTO RÍGIDO PVC CINZA 3/4"</p> <p>8586 ELETRODUTO RÍGIDO PVC CINZA 1"</p>

ULTRA

ELETRIK



ELETRODUTO FLEXÍVEL CORRUGADO CINZA

999	20MM - 50M
998	25MM - 50M
1000	32MM - 25M

SUPORTE PARA LAJE AMARELO

5169	25CM
5170	30CM



7413 - CAIXINHA DE LUZ 4X2 AMARELA PRIME PVC



7414 - CAIXINHA DE LUZ 4X4 AMARELA PRIME PVC



7490 - PLAFON BOCAL PORCELANA BRANCO 100W 250V



ELÉTRICA



FORTLEV

CÓD.	DESCRIÇÃO
2085	ELETRODUTO FLEX. COR. 25MM LARANJA - 50 MT
2086	ELETRODUTO FLEX. COR. 32MM LARANJA - 25 MT



FORTLEV

CÓD.	DESCRIÇÃO
733	ELETRODUTO FLEX. COR. 20MM AMARELO - 50 MT
734	ELETRODUTO FLEX. COR. 32MM AMARELO - 25 MT



DUAL
PLÁSTICOS

CÓD.	DESCRIÇÃO
8557	ELETRODUTO CORRUGADO REF. DUAL 25MM PRETO



ULTRA

CÓD.	DESCRIÇÃO
999	ELETROD. FLEX. CORRUGADO 20 MM - 50 MT
99810	ELETROD. FLEX. CORRUGADO 25 MM - 50 MT
1000	ELETROD. FLEX. CORRUGADO 32 MM - 25 MT



ULTRA

CÓD.	DESCRIÇÃO
7413	CAIXINHA DE LUZ 4X2 AMARELA PRIME PVC ULTRA
7414	CAIXINHA DE LUZ 4X4 AMARELO PVC ULTRA



RIBEIRO
PLÁSTICOS

CÓD.	DESCRIÇÃO
1327	CAIXINHA DE LUZ 4X4 VERDE
1326	CAIXINHA DE LUZ 4X2 VERDE



RIBEIRO
PLÁSTICOS

CÓD.	DESCRIÇÃO
1420	CAIXINHA FMS VERDE RIBEIRO
1421	CAIXINHA FMD VERDE RIBEIRO



ULTRA

CÓD.	DESCRIÇÃO
5169	SUPORTE P/LAJE 25 CM AMARELO ULTRA
5170	SUPORTE P/LAJE 30 CM AMARELO ULTRA



FORTLEV

CÓD.	DESCRIÇÃO
1976	SUPORTE PARA LAJE 25 CM LARANJA
1977	SUPORTE PARA LAJE 30 CM LARANJA



FORTLEV

CÓD.	DESCRIÇÃO
735	LUVA DE PRESSÃO ELETROD. VLEXIVEL 20 MM
736737	LUVA DE PRESSÃO ELETROD. VLEXIVEL 25 MM
737	LUVA DE PRESSÃO ELETROD. VLEXIVEL 32 MM



MONDIALE

CÓD.	DESCRIÇÃO
4997	SUPORTE P/LAJE REGULÁVEL 25/31CM PRETA



RIBEIRO
PLÁSTICOS

CÓD.	DESCRIÇÃO
1324	SUPORTE P/ LAJE 25 CM VERDE
1325	SUPORTE P/ LAJE 30 CM VERDE

ELÉTRICA

 	 	 
<p>CÓD. DESCRIÇÃO 1272 CX PROT C/TOM BCA 2P+T 20A/250V</p>	<p>CÓD. DESCRIÇÃO 1274 CX EMB DISJ 1P 20A MW 120E+TOM 21</p>	<p>CÓD. DESCRIÇÃO 1271 CX EMB C/TOM BCA 2P+T 20A/250V</p>
 	 	 
<p>CÓD. DESCRIÇÃO 1273 CX SOB DISJ 1P 20A MW 120E+TOM 20</p>	<p>CÓD. DESCRIÇÃO 6241 CAIXA SOBREPOR PARA 1 DISJUNTOR DIN/NEMA</p>	<p>CÓD. DESCRIÇÃO 4998 CENTRINHO DIST 01 DISJ. BRANCO</p>
 	 	 
<p>CÓD. DESCRIÇÃO 4999 CAIXA DE PASSAGEM 10X10 PLÁSTICA EMBUTIR 5000 CAIXA DE PASSAGEM 15X15 PLÁSTICA EMBUTIR 8011 CAIXA DE PASSAGEM 20X20 PLÁSTICA EMBUTIR</p>	<p>CÓD. DESCRIÇÃO 1321 CENTRINHO DIST 03 NEMA OU 04 DIN 1322 CENTRINHO DIST 06 NEMA OU 08 DIN 1323 CENTRINHO DIST 12 NEMA OU 16 DIN</p>	<p>CÓD. DESCRIÇÃO 1175 CENTRINHO DIST 04 NEMA OU 07 DIN 12691268 CENTRINHO DIST 06 NEMA OU 09 DIN 1268 CENTRINHO DIST 09 NEMA OU 13 DIN</p>
 	 	 
<p>CÓD. DESCRIÇÃO 1971 CAIXA DE PASSAGEM 10X10 METAL 1972 CAIXA DE PASSAGEM 15X15 METAL 1973 CAIXA DE PASSAGEM 20X20 METAL</p>	<p>CÓD. DESCRIÇÃO 3092 CENTRINHO DIST 03 NEMA OU 04 DIN TAM. FUMÊ 3093 CENTRINHO DIST 06 NEMA OU 08 DIN TAM. FUMÊ 3884 CENTRINHO DIST 12 NEMA OU 16 DIN TAM. FUMÊ</p>	<p>CÓD. DESCRIÇÃO 3372 CENTRINHO DIST 03 NEMA OU 04 DIN TAM. BRANCA 3373 CENTRINHO DIST 06 NEMA OU 08 DIN TAM. BRANCA 3885 CENTRINHO DIST 12 NEMA OU 16 DIN TAM. BRANCA</p>
 	 	 
<p>CÓD. DESCRIÇÃO 7359 DISJ ENERGIA SOLAR 250A XT4N AJUSTAVEL 200A TRIPOLAR</p>	<p>CÓD. DESCRIÇÃO 6955 DISJ FORMULA TRIPOLAR 100A PADRAO CEMIG</p>	<p>CÓD. DESCRIÇÃO 7225 DISJ DIN BIPOLAR 63A PADRAO CEMIG ELETROMAR J6W263</p>

ELÉTRICA



CÓD.	DESCRIÇÃO
3999	DISJ DIN MONO 6A
4000	DISJ DIN MONO 10A
4001	DISJ DIN MONO 16A
4002	DISJ DIN MONO 20A
4003	DISJ DIN MONO 25A
4004	DISJ DIN MONO 32A
4005	DISJ DIN MONO 40A
4006	DISJ DIN MONO 50A
4007	DISJ DIN MONO 63A
4008	DISJ DIN BIPOLAR 10A
4009	DISJ DIN BIPOLAR 16A
4010	DISJ DIN BIPOLAR 20A
4011	DISJ DIN BIPOLAR 25A
4012	DISJ DIN BIPOLAR 32A
4013	DISJ DIN BIPOLAR 40A
4014	DISJ DIN BIPOLAR 50A
4015	DISJ DIN BIPOLAR 63A
4016	DISJ DIN TRIPOLAR 10A
4017	DISJ DIN TRIPOLAR 16A
4018	DISJ DIN TRIPOLAR 20A
4019	DISJ DIN TRIPOLAR 25A
4020	DISJ DIN TRIPOLAR 32A
4021	DISJ DIN TRIPOLAR 40A
4022	DISJ DIN TRIPOLAR 50A
4023	DISJ DIN TRIPOLAR 63A
4024	DISJ DIN MONO 40A PADRAO CEMIG ABB
4025	DISJ DIN MONO 50A PADRAO CEMIG ABB
4026	DISJ DIN MONO 63A PADRAO CEMIG ABB
4027	DISJ DIN BIPOLAR 40A PADRAO CEMIG ABB
4028	DISJ DIN BIPOLAR 63A PADRAO CEMIG ABB
4029	DISJ DIN TRIPOLAR 40A PADRAO CEMIG
4030	DISJ DIN TRIPOLAR 63A PADRAO CEMIG ABB
6392	DISJ DIN TRIPOLAR 125A PADRAO CEMIG GE
6202	DISJ DIN TRIPOLAR 200A PADRAO CEMIG GE



CÓD.	DESCRIÇÃO
1590	DISJUNTOR DIN MONO 6A
1591	DISJUNTOR DIN MONO 10A
1592	DISJUNTOR DIN MONO 16A
1593	DISJUNTOR DIN MONO 20A
1594	DISJUNTOR DIN MONO 25A
1595	DISJUNTOR DIN MONO 32A
1596	DISJUNTOR DIN MONO 40A
1597	DISJUNTOR DIN MONO 50A
1598	DISJUNTOR DIN MONO 63A
1599	DISJUNTOR DIN MONO 70A
1600	DISJUNTOR DIN BIPOLAR 6A
1601	DISJUNTOR DIN BIPOLAR 10A
1602	DISJUNTOR DIN BIPOLAR 16A
1603	DISJUNTOR DIN BIPOLAR 20A
1604	DISJUNTOR DIN BIPOLAR 25A
1605	DISJUNTOR DIN BIPOLAR 32A
1606	DISJUNTOR DIN BIPOLAR 40A
1607	DISJUNTOR DIN BIPOLAR 50A
1608	DISJUNTOR DIN BIPOLAR 63A
1609	DISJUNTOR DIN BIPOLAR 70A
1611	DISJUNTOR DIN TRIPOLAR 10A
1612	DISJUNTOR DIN TRIPOLAR 16A
1613	DISJUNTOR DIN TRIPOLAR 20A
1614	DISJUNTOR DIN TRIPOLAR 25A
1615	DISJUNTOR DIN TRIPOLAR 32A
1616	DISJUNTOR DIN TRIPOLAR 40A
1617	DISJUNTOR DIN TRIPOLAR 50A
1618	DISJUNTOR DIN TRIPOLAR 63A
1619	DISJUNTOR DIN TRIPOLAR 70A
6242	DISJ DIN MONO 40A PADRAO CEMIG
6243	DISJ DIN MONO 50A PADRAO CEMIG
6244	DISJ DIN MONO 63A PADRAO CEMIG



CÓD.	DESCRIÇÃO
4031	DISJ NEMA MONO 10A
4032	DISJ NEMA MONO 15A
4033	DISJ NEMA MONO 20A
4034	DISJ NEMA MONO 25A
4035	DISJ NEMA MONO 30A
4036	DISJ NEMA MONO 35A
4037	DISJ NEMA MONO 40A
4038	DISJ NEMA BIPOLAR 20A
4039	DISJ NEMA BIPOLAR 25A
4040	DISJ NEMA BIPOLAR 30A
4041	DISJ NEMA BIPOLAR 35A
4042	DISJ NEMA BIPOLAR 40A
4051	DISJ NEMA BIPOLAR 50A
4043	DISJ NEMA BIPOLAR 60A
4044	DISJ NEMA BIPOLAR 70A
4045	DISJ NEMA TRIPOLAR 40A
4046	DISJ NEMA TRIPOLAR 60A
4053	DISJ NEMA TRIPOLAR 50A
4047	DISJ NEMA TRIPOLAR 70A
4048	DISJ NEMA TRIPOLAR 90A
4052	DISJ NEMA TRIPOLAR 100A
4054	DISJ NEMA TRIPOLAR 120A
4049	DISJ NEMA TRIPOLAR 150A



CÓD.	DESCRIÇÃO
7355	DISJ DIN BIPOLAR 100A PADRAO CEMIG GE ABB
7356	DISJ DIN BIPOLAR 125A PADRAO CEMIG GE ABB
7354	DISJ DIN BIPOLAR 80A PADRAO CEMIG GE ABB
7358	DISJ DIN TRIPOLAR 100A PADRAO CEMIG GE ABB
7357	DISJ DIN TRIPOLAR 80A PADRAO CEMIG GE ABB



CÓD.	DESCRIÇÃO
6777	DISJUNTOR DIN MONO 10A
6778	DISJUNTOR DIN MONO 16A
6779	DISJUNTOR DIN MONO 20A
6780	DISJUNTOR DIN MONO 25A
6781	DISJUNTOR DIN MONO 32A
6782	DISJUNTOR DIN MONO 40A
6783	DISJUNTOR DIN MONO 50A
6784	DISJUNTOR DIN MONO 63A
6774	DISJUNTOR DIN BIPOLAR 32A
6775	DISJUNTOR DIN BIPOLAR 40A
6776	DISJUNTOR DIN BIPOLAR 50A
6768	DISJUNTOR DIN BIPOLAR 63A



CÓD.	DESCRIÇÃO
7473	DISJ DIN TRIPOLAR 10A

ELÉTRICA



SOPRANO

CÓD.	DESCRIÇÃO
8728	DISJUNTOR DIN MONO 10A
8729	DISJUNTOR DIN MONO 16A
8730	DISJUNTOR DIN MONO 20A
8731	DISJUNTOR DIN MONO 25A
8734	DISJUNTOR DIN MONO 32A
8735	DISJUNTOR DIN MONO 40A
8732	DISJUNTOR DIN MONO 50A
8733	DISJUNTOR DIN MONO 63A



SOPRANO

CÓD.	DESCRIÇÃO
8736	DISJUNTOR DIN BIPOLAR 10A
8737	DISJUNTOR DIN BIPOLAR 16A
8738	DISJUNTOR DIN BIPOLAR 20A
8739	DISJUNTOR DIN BIPOLAR 25A
8740	DISJUNTOR DIN BIPOLAR 32A
8741	DISJUNTOR DIN BIPOLAR 40A
8742	DISJUNTOR DIN BIPOLAR 50A
8743	DISJUNTOR DIN BIPOLAR 63A



SOPRANO

CÓD.	DESCRIÇÃO
8744	DISJUNTOR DIN TRIPOLAR 10A
8745	DISJUNTOR DIN TRIPOLAR 16A
8746	DISJUNTOR DIN TRIPOLAR 20A
8747	DISJUNTOR DIN TRIPOLAR 25A
8748	DISJUNTOR DIN TRIPOLAR 32A
8749	DISJUNTOR DIN TRIPOLAR 40A
8750	DISJUNTOR DIN TRIPOLAR 50A
8751	DISJUNTOR DIN TRIPOLAR 63A



SOPRANO

CÓD.	DESCRIÇÃO
8769	DISJUNTOR DIN MONO 63A PADRAO CEMIG



SOPRANO

CÓD.	DESCRIÇÃO
8770	DISJUNTOR DIN BIPOLAR 63A PADRÃO CEMIG



SOPRANO

CÓD.	DESCRIÇÃO
8771	DISJUNTOR DIN TRIPOLAR 63A PADRAO CEMIG



SOPRANO

CÓD.	DESCRIÇÃO
8755	DISJUNTOR NEMA MONO 10A
8754	DISJUNTOR NEMA MONO 15A
8753	DISJUNTOR NEMA MONO 20A
8752	DISJUNTOR NEMA MONO 25A
8811	DISJUNTOR NEMA MONO 30A
8812	DISJUNTOR NEMA MONO 35A
8756	DISJUNTOR NEMA MONO 40A
8757	DISJUNTOR NEMA MONO 50A
8758	DISJUNTOR NEMA MONO 70A
8870	DISJUNTOR NEMA MONO 80A
8869	DISJUNTOR NEMA MONO 90A



SOPRANO

CÓD.	DESCRIÇÃO
8762	DISJUNTOR NEMA BIPOLAR 15A
8761	DISJUNTOR NEMA BIPOLAR 20A
8760	DISJUNTOR NEMA BIPOLAR 25A
8759	DISJUNTOR NEMA BIPOLAR 30A
8766	DISJUNTOR NEMA BIPOLAR 40A
8767	DISJUNTOR NEMA BIPOLAR 50A
8768	DISJUNTOR NEMA BIPOLAR 60A
8765	DISJUNTOR NEMA BIPOLAR 70A
8764	DISJUNTOR NEMA BIPOLAR 80A
8763	DISJUNTOR NEMA BIPOLAR 90A



SOPRANO

CÓD.	DESCRIÇÃO
8832	DISJUNTOR NEMA TRIPOLAR 40A



SOPRANO

CÓD.	DESCRIÇÃO
8778	BARRAMENTO PENTE 54 PINOS 1 M. 63A TRIPOLAR
8777	BARRAMENTO PENTE 54 PINOS 1 M. 63A MONO
8776	BARRAMENTO PENTE 54 PINOS 1 M. 63A BIPOLAR



Sile

CÓD.	DESCRIÇÃO
8880	CABO SIL FLEXÍVEL 1,50MM AMARELO
8877	CABO SIL FLEXÍVEL 1,50MM AZUL8876 CABO SIL FLEXÍVEL 1,50MM BRANCO
8876	CABO SIL FLEXÍVEL 1,50MM BRANCO
8875	CABO SIL FLEXÍVEL 1,50MM PRETO
8879	CABO SIL FLEXÍVEL 1,50MM VERDE8878 CABO SIL FLEXÍVEL 1,50MM VERMELHO8878 CABO SIL FLEXÍVEL 1,50MM VERMELHO
8878	CABO SIL FLEXÍVEL 1,50MM VERMELHO8900 CABO SIL FLEXÍVEL 1,50MM VERMELHO
8900	CABO SIL FLEXÍVEL 10,00MM AZUL 8899 CABO SIL FLEXÍVEL 10,00MM AZUL
8899	CABO SIL FLEXÍVEL 10,00MM PRETO
8902	CABO SIL FLEXÍVEL 10,00MM VERDE 8901 CABO SIL FLEXÍVEL 10,00MM VERDE
8901	CABO SIL FLEXÍVEL 10,00MM VERMELHO 8904 CABO SIL FLEXÍVEL 10,00MM VERMELHO
8904	CABO SIL FLEXÍVEL 16,00MM AZUL 8903 CABO SIL FLEXÍVEL 16,00MM AZUL
8903	CABO SIL FLEXÍVEL 16,00MM PRETO
8906	CABO SIL FLEXÍVEL 16,00MM VERDE 8905 CABO SIL FLEXÍVEL 16,00MM VERDE
8905	CABO SIL FLEXÍVEL 16,00MM VERMELHO

8886	CABO SIL FLEXÍVEL 2,50MM AMARELO
8882	CABO SIL FLEXÍVEL 2,50MM BRANCO
8881	CABO SIL FLEXÍVEL 2,50MM PRETO
8885	CABO SIL FLEXÍVEL 2,50MM VERDE8884 CABO SIL FLEXÍVEL 2,50MM VERDE
8884	CABO SIL FLEXÍVEL 2,50MM VERMELHO8892 CABO SIL FLEXÍVEL 2,50MM VERMELHO
8892	CABO SIL FLEXÍVEL 4,00MM AMARELO
8889	CABO SIL FLEXÍVEL 4,00MM AZUL 8888 CABO SIL FLEXÍVEL 4,00MM AZUL
8888	CABO SIL FLEXÍVEL 4,00MM BRANCO
8887	CABO SIL FLEXÍVEL 4,00MM PRETO
8891	CABO SIL FLEXÍVEL 4,00MM VERDE8890 CABO SIL FLEXÍVEL 4,00MM VERDE
8890	CABO SIL FLEXÍVEL 4,00MM VERMELHO8898 CABO SIL FLEXÍVEL 4,00MM VERMELHO
8898	CABO SIL FLEXÍVEL 6,00MM AMARELO
8896	CABO SIL FLEXÍVEL 6,00MM BRANCO
8894	CABO SIL FLEXÍVEL 6,00MM BRANCO
8893	CABO SIL FLEXÍVEL 6,00MM PRETO
8879	CABO SIL FLEXÍVEL 6,00MM VERMELHO8896 CABO SIL FLEXÍVEL 6,00MM VERMELHO
8898	CABO SIL FLEXÍVEL 6,00MM VERMELHO8907 CABO SIL FLEXÍVEL 6,00MM VERMELHO
8900	CABO SIL PARALELO 2 X 0,75MM BRANCO
8908	CABO SIL PARALELO 2 X 1,00MM BRANCO
8909	CABO SIL PARALELO 2 X 1,50MM BRANCO
8910	CABO SIL PARALELO 2 X 1,50MM BRANCO
8910	CABO SIL PARALELO 2 X 1,50MM MARRON
8910	CABO SIL PARALELO 2 X 2,50MM BRANCO
8912	CABO SIL PARALELO 2 X 2,50MM MARRON
8913	CABO SIL PARALELO 2 X 2,50MM MARRON
8914	CABO SIL PP FLEXÍVEL 2 X 2,50MM
8914	CABO SIL PP FLEXÍVEL 2 X 2,50MM

ELÉTRICA



CÓD.	DESCRIÇÃO
4478	CABO FLEXIVEL 1,50 MM PRETO (RL 100M)
4479	CABO FLEXIVEL 1,50 MM AZUL (RL 100M)
4480	CABO FLEXIVEL 1,50 MM VERDE (RL 100M)
4481	CABO FLEXIVEL 1,50 MM VERMELHO (RL 100M)
4482	CABO FLEXIVEL 1,50 MM AMARELO (RL 100M)
4483	CABO FLEXIVEL 1,50 MM BRANCO (RL 100M)
4484	CABO FLEXIVEL 2,50 MM PRETO (RL 100M)
4485	CABO FLEXIVEL 2,50 MM AZUL (RL 100M)
4486	CABO FLEXIVEL 2,50 MM VERDE (RL 100M)
4487	CABO FLEXIVEL 2,50 MM VERMELHO (RL 100M)
4488	CABO FLEXIVEL 2,50 MM AMARELO (RL 100M)
4489	CABO FLEXIVEL 2,50 MM BRANCO (RL 100M)
4490	CABO FLEXIVEL 4,00 MM PRETO (RL 100M)
4491	CABO FLEXIVEL 4,00 MM BRANCO (RL 100M)
4492	CABO FLEXIVEL 4,00 MM AZUL (RL 100M)
4493	CABO FLEXIVEL 4,00 MM VERDE (RL 100M)
4494	CABO FLEXIVEL 4,00 MM VERMELHO (RL 100M)
4495	CABO FLEXIVEL 4,00 MM AMARELO (RL 100M)
4496	CABO FLEXIVEL 6,00 MM PRETO (RL 100M)
4497	CABO FLEXIVEL 6,00 MM AZUL (RL 100M)
4498	CABO FLEXIVEL 6,00 MM VERMELHO (RL 100M)
4499	CABO FLEXIVEL 6,00 MM VERDE (RL 100M)
4500	CABO FLEXIVEL 6,00 MM AMARELO (RL 100M)
4501	CABO FLEXIVEL 6,00 MM BRANCO (RL 100M)
4502	CABO FLEXIVEL 10,00 MM PRETO (RL 100M)
4503	CABO FLEXIVEL 10,00 MM AZUL (RL 100M)
4923	CABO FLEXIVEL 10,00 MM VERDE (RL 100M)
4842	CABO FLEXIVEL 10,00 MM VERM. (RL 100M)
4504	CABO FLEXIVEL 16,00 MM PRETO (RL 100M)
4505	CABO FLEXIVEL 16,00 MM AZUL (RL 100M)
6633	CABO FLEXIVEL 16,00 MM VERDE (RL 100M)
6634	CABO FLEXIVEL 16,00 MM VERMELHO (RL 100M)
6405	CABO PARALELO 2 X 0,75MM BRANCO (RL 100M)
6401	CABO PARALELO 2 X 1,00MM BRANCO (RL 100M)
4506	CABO PARALELO 2 X 1,50 MM BR. (RL 100M)
4595	CABO PARALELO 2 X 1,50MM MARR (RL 100M)
4507	CABO PARALELO 2 X 2,50 MM BR. (RL 100M)
4602	CABO PARALELO 2 X 2,50MM MARR (RL 100M)
6663	CABO PARALELO 2 X 4,00MM BRANCO (RL 100M)
4508	CABO PP FLEXIVEL 2X1,50 MM (RL 100 M)
4509	CABO PP FLEXIVEL 2X2,50 MM (RL 100 M)
4764	CABO PP FLEXIVEL 3X1,50 MM (RL 100 M)
4765	CABO PP FLEXIVEL 3X2,50 MM (RL 100 M)
4766	CABO PP FLEXIVEL 3X4,00 MM (RL 100 M)
4767	CABO PP FLEXIVEL 3X6,00 MM (RL 100 M)



CÓD.	DESCRIÇÃO
5710	CABO FLEXIVEL 1,50 MM AMARELO - RL 100M
4157	CABO FLEXIVEL 1,50 MM AZUL - RL 100M
5711	CABO FLEXIVEL 1,50 MM BRANCO - RL 100M
4158	CABO FLEXIVEL 1,50 MM PRETO - RL 100M
4159	CABO FLEXIVEL 1,50 MM VERDE - RL 100M
5712	CABO FLEXIVEL 1,50 MM VERMELHO - RL 100M
5715	CABO FLEXIVEL 2,50 MM AMARELO - RL 100M
4160	CABO FLEXIVEL 2,50 MM AZUL - RL 100M
5716	CABO FLEXIVEL 2,50 MM BRANCO - RL 100M
4161	CABO FLEXIVEL 2,50 MM PRETO - RL 100M
4162	CABO FLEXIVEL 2,50 MM VERDE - RL 100M
5717	CABO FLEXIVEL 2,50 MM VERMELHO - RL 100M
5718	CABO FLEXIVEL 4,00 MM AMARELO - RL 100M
4163	CABO FLEXIVEL 4,00 MM AZUL - RL 100M
5719	CABO FLEXIVEL 4,00 MM BRANCO - RL 100M
4164	CABO FLEXIVEL 4,00 MM PRETO - RL 100M
4165	CABO FLEXIVEL 4,00 MM VERDE - RL 100M
5720	CABO FLEXIVEL 4,00 MM VERMELHO - RL 100M
5721	CABO FLEXIVEL 6,00 MM AMARELO - RL 100M
4166	CABO FLEXIVEL 6,00 MM AZUL - RL 100M
5722	CABO FLEXIVEL 6,00 MM BRANCO - RL 100M
4167	CABO FLEXIVEL 6,00 MM PRETO - RL 100M
4168	CABO FLEXIVEL 6,00 MM VERDE - RL 100M
5723	CABO FLEXIVEL 6,00 MM VERMELHO - RL 100M
4169	CABO FLEXIVEL 10,00 MM AZUL - RL 100M
4170	CABO FLEXIVEL 10,00 MM PRETO - RL 100M
4171	CABO FLEXIVEL 10,00 MM VERDE - RL 100M
5713	CABO FLEXIVEL 10,00 MM VERMELHO - RL 100M
5714	CABO FLEXIVEL 16,00 MM AZUL - RL 100M
4172	CABO FLEXIVEL 16,00 MM PRETO - RL 100M
7329	CABO FLEXIVEL 16,00 MM VERDE - RL 100M
7328	CABO FLEXIVEL 16,00 MM VERMELHO - RL 100M
5724	CABO FLEXIVEL PARALELO 2 X 1,50 MM BRANCO
5725	CABO FLEXIVEL PARALELO 2 X 2,50 MM BRANCO
6785	CABO PP FLEXIVEL 2X1,50 MM (RL 100 M)
6786	CABO PP FLEXIVEL 2X2,50 MM (RL 100 M)



CÓD.	DESCRIÇÃO
7448	BOBINA CABO 1,50 MM VERDE 1400 METROS
7456	BOBINA CABO 1,50 MM AZUL 1400 METROS
7457	BOBINA CABO 1,50 MM PRETO 1400 METROS
7458	BOBINA CABO 1,50 MM VERMELHO 1400 METROS
7459	BOBINA CABO 2,50 MM VERDE 1000 METROS
7460	BOBINA CABO 2,50 MM VERMELHO 1000 METROS
7461	BOBINA CABO 4,00 MM AZUL 800 METROS
7462	BOBINA CABO 4,00 MM BRANCO 800 METROS
7463	BOBINA CABO 4,00 MM PRETO 800 METROS
7464	BOBINA CABO 4,00 MM VERMELHO 800 METROS
7449	BOBINA CABO 6,00 MM AZUL 500 METROS
7450	BOBINA CABO 6,00 MM VERMELHO 500 METROS
7451	BOBINA CABO 6,00 MM VERDE 500 METROS
6802	BOBINA CABO 10,00 MM PRETO 500 METROS
7183	BOBINA CABO 10,00 MM AZUL 500 METROS
6661	BOBINA CABO 16,00 MM PRETO 500 METROS
6662	BOBINA CABO 16,00 MM AZUL 500 METROS
7338	BOBINA CABO 25,00 MM PRETO 500 METROS
7477	BOBINA CABO 1,50 MM BRANCO 1400 METROS
7478	BOBINA CABO 2,50 MM PRETO 1000 METROS
7479	BOBINA CABO 2,50 MM AZUL 1000 METROS
7480	BOBINA CABO 6,00 MM PRETO 500 METROS



CÓD.	DESCRIÇÃO
6210	CABO REDE/ALARME/CFTV ULTRA 300M AZUL
6211	CABO REDE/ALARME/CFTV ULTRA 300M PRETO
6212	CABO REDE/ALARME/CFTV ULTRA 300M BRANCO



CÓD.	DESCRIÇÃO
7482	BOBINA CABO PARALELO 2 X 1,50 MM 700M BRANC
7483	BOBINA CABO PARALELO 2 X 2,50 MM 500M BRANC



CÓD.	DESCRIÇÃO
8017	CABO CAT5E CM COMUN. DE DADOS LAN 4P PRETO
8018	CABO CAT5E CM COMUN. DE DADOS LAN 4P BR.
8019	CABO CAT5E CM COMUN. DE DADOS LAN 4P AZUL



CÓD.	DESCRIÇÃO
7252	CABO COAXIAL BOBINA 300M RG 59 75 OHMS 67%
6209	CABO COAXIAL RG 60 75 OHMS 67% 100M TS















CÓD.	DESCRIÇÃO
7232	BOBINA CABO 10,00 MM AZUL 500 METROS FLEX
7231	BOBINA CABO 10,00 MM PRETO 500 METROS FLEX
7233	BOBINA CABO 16,00 MM AZUL 500 METROS FLEX
7234	BOBINA CABO 16,00 MM PRETO 500 METROS FLEX

















CÓD.	DESCRIÇÃO
8548	BOBINA CABO PARALELO 2 X 1.50MM BRANCO 500M
8549	BOBINA CABO PARALELO 2 X 2.50MM BRANCO 500M

ELÉTRICA

 <p>Mec-Tronic</p>	 <p>Mec-Tronic</p>	 <p>Mec-Tronic</p>
<p>CÓD. 1180</p> <p>DESCRIÇÃO SIST X 2 INT SIMP</p>	<p>CÓD. 1186</p> <p>DESCRIÇÃO SIST X INT SIMP+TOM 2P+T</p>	<p>CÓD. 6645</p> <p>DESCRIÇÃO INTERRUPTOR EXTER + TOM 2P+T 10A CINZA</p> <p>CÓD. 6235</p> <p>DESCRIÇÃO INTERRUPTOR EXTER + TOM 2P+T 10A BRANCO</p> <p>CÓD. 7224</p> <p>DESCRIÇÃO INTERRUPTOR EXTER PARAL + TOM 2P+T 10A BEGE</p>
 <p>Mec-Tronic</p>	 <p>Mec-Tronic</p>	 <p>Mec-Tronic</p>
<p>CÓD. 1185</p> <p>DESCRIÇÃO SIST X TOMADA RJ45</p>	<p>CÓD. 1184</p> <p>DESCRIÇÃO SIST X TOMADA DUPLO JACK</p>	<p>CÓD. 3004</p> <p>DESCRIÇÃO CAIXA SOB P/02 MOD 75X75X48 PETRA</p>
 <p>Mec-Tronic</p>	 <p>Mec-Tronic</p>	 <p>Mec-Tronic</p>
<p>CÓD. 3003</p> <p>DESCRIÇÃO CAIXA SOB P/01 MOD 75X75X48 PETRA</p>	<p>CÓD. 1151</p> <p>DESCRIÇÃO CAIXA SOBREPOR 4X2 MILL</p>	<p>CÓD. 1176</p> <p>DESCRIÇÃO TOMADA EXT 2P+T 10A/250V BCO</p> <p>CÓD. 1178</p> <p>DESCRIÇÃO TOMADA EXT 2P+T 20A/250V BCO</p>
 <p>prismatec</p>	 <p>Mec-Tronic</p>	 <p>Mec-Tronic</p>
<p>CÓD. 4908</p> <p>DESCRIÇÃO TOMADA EXT 2P+T 10A/250V BCO</p>	<p>CÓD. 6230</p> <p>DESCRIÇÃO INTERRUPTOR PERA 10A/250V</p>	<p>CÓD. 6229</p> <p>DESCRIÇÃO MIOLO TOMADA SISTEMA X 10A/250V S/PL 2P+T</p>
 <p>TRAMONTINA</p>	 <p>prismatec</p>	 <p>Mec-Tronic</p>
<p>CÓD. 6470</p> <p>DESCRIÇÃO PINO MACHO 2P 10A/250V (POTE 42 UN)</p>	<p>CÓD. 3531</p> <p>DESCRIÇÃO PINO MACHO 2P 10A/250</p> <p>CÓD. 3532</p> <p>DESCRIÇÃO PINO MACHO 2P 20A/250</p>	<p>CÓD. 1494</p> <p>DESCRIÇÃO PINO MACHO 2P 10A/250V BRANCO</p> <p>CÓD. 1495</p> <p>DESCRIÇÃO PINO MACHO 2P 20A/250V BRANCO</p>

ELÉTRICA

 <p style="text-align: right;">prismaTEE</p>	 <p style="text-align: right;">Mec-Tronic</p>	 <p style="text-align: right;">TRAMONTINA</p>																		
<table border="1"> <thead> <tr> <th>CÓD.</th> <th>DESCRIÇÃO</th> </tr> </thead> <tbody> <tr> <td>3508</td> <td>PINO MACHO 2P+T 10A/250</td> </tr> <tr> <td>3509</td> <td>PINO MACHO 2P+T 20A/250V</td> </tr> </tbody> </table>	CÓD.	DESCRIÇÃO	3508	PINO MACHO 2P+T 10A/250	3509	PINO MACHO 2P+T 20A/250V	<table border="1"> <thead> <tr> <th>CÓD.</th> <th>DESCRIÇÃO</th> </tr> </thead> <tbody> <tr> <td>1497</td> <td>PINO MACHO 2P+T 10A/250V BRANCO</td> </tr> <tr> <td>1498</td> <td>PINO MACHO 2P+T 20A/250V BRANCO</td> </tr> </tbody> </table>	CÓD.	DESCRIÇÃO	1497	PINO MACHO 2P+T 10A/250V BRANCO	1498	PINO MACHO 2P+T 20A/250V BRANCO	<table border="1"> <thead> <tr> <th>CÓD.</th> <th>DESCRIÇÃO</th> </tr> </thead> <tbody> <tr> <td>6506</td> <td>PINO MACHO 2P+T 20A/250V BRANCO</td> </tr> <tr> <td>6468</td> <td>PINO MACHO 2P+T 10A/250V BRANCO</td> </tr> </tbody> </table>	CÓD.	DESCRIÇÃO	6506	PINO MACHO 2P+T 20A/250V BRANCO	6468	PINO MACHO 2P+T 10A/250V BRANCO
CÓD.	DESCRIÇÃO																			
3508	PINO MACHO 2P+T 10A/250																			
3509	PINO MACHO 2P+T 20A/250V																			
CÓD.	DESCRIÇÃO																			
1497	PINO MACHO 2P+T 10A/250V BRANCO																			
1498	PINO MACHO 2P+T 20A/250V BRANCO																			
CÓD.	DESCRIÇÃO																			
6506	PINO MACHO 2P+T 20A/250V BRANCO																			
6468	PINO MACHO 2P+T 10A/250V BRANCO																			
 <p style="text-align: right;">Mec-Tronic</p>	 <p style="text-align: right;">Mec-Tronic</p>	 <p style="text-align: right;">Mec-Tronic</p>																		
<table border="1"> <thead> <tr> <th>CÓD.</th> <th>DESCRIÇÃO</th> </tr> </thead> <tbody> <tr> <td>3432</td> <td>PINO ADAP UNIV 2P+T 10A PTOM 250V</td> </tr> </tbody> </table>	CÓD.	DESCRIÇÃO	3432	PINO ADAP UNIV 2P+T 10A PTOM 250V	<table border="1"> <thead> <tr> <th>CÓD.</th> <th>DESCRIÇÃO</th> </tr> </thead> <tbody> <tr> <td>6231</td> <td>PINO MACHO TRIANGULAR 2P 10A/250V</td> </tr> </tbody> </table>	CÓD.	DESCRIÇÃO	6231	PINO MACHO TRIANGULAR 2P 10A/250V	<table border="1"> <thead> <tr> <th>CÓD.</th> <th>DESCRIÇÃO</th> </tr> </thead> <tbody> <tr> <td>5659</td> <td>PINO MACHO PLUGUE FORTE 2P+T 20A/250V BR</td> </tr> </tbody> </table>	CÓD.	DESCRIÇÃO	5659	PINO MACHO PLUGUE FORTE 2P+T 20A/250V BR						
CÓD.	DESCRIÇÃO																			
3432	PINO ADAP UNIV 2P+T 10A PTOM 250V																			
CÓD.	DESCRIÇÃO																			
6231	PINO MACHO TRIANGULAR 2P 10A/250V																			
CÓD.	DESCRIÇÃO																			
5659	PINO MACHO PLUGUE FORTE 2P+T 20A/250V BR																			
 <p style="text-align: right;">prismaTEE</p>	 <p style="text-align: right;">Mec-Tronic</p>	 <p style="text-align: right;">TRAMONTINA</p>																		
<table border="1"> <thead> <tr> <th>CÓD.</th> <th>DESCRIÇÃO</th> </tr> </thead> <tbody> <tr> <td>3527</td> <td>PINO FEMEA 2P 10A/250</td> </tr> </tbody> </table>	CÓD.	DESCRIÇÃO	3527	PINO FEMEA 2P 10A/250	<table border="1"> <thead> <tr> <th>CÓD.</th> <th>DESCRIÇÃO</th> </tr> </thead> <tbody> <tr> <td>1496</td> <td>PINO FÊMEA 2P 10A/250V BRANCO</td> </tr> </tbody> </table>	CÓD.	DESCRIÇÃO	1496	PINO FÊMEA 2P 10A/250V BRANCO	<table border="1"> <thead> <tr> <th>CÓD.</th> <th>DESCRIÇÃO</th> </tr> </thead> <tbody> <tr> <td>6471</td> <td>PINO FEMEA 2P 10A 250V (POTE 24 UN)</td> </tr> </tbody> </table>	CÓD.	DESCRIÇÃO	6471	PINO FEMEA 2P 10A 250V (POTE 24 UN)						
CÓD.	DESCRIÇÃO																			
3527	PINO FEMEA 2P 10A/250																			
CÓD.	DESCRIÇÃO																			
1496	PINO FÊMEA 2P 10A/250V BRANCO																			
CÓD.	DESCRIÇÃO																			
6471	PINO FEMEA 2P 10A 250V (POTE 24 UN)																			
 <p style="text-align: right;">prismaTEE</p>	 <p style="text-align: right;">Mec-Tronic</p>	 <p style="text-align: right;">TRAMONTINA</p>																		
<table border="1"> <thead> <tr> <th>CÓD.</th> <th>DESCRIÇÃO</th> </tr> </thead> <tbody> <tr> <td>3529</td> <td>PINO FEMEA 2P+T 10A/250</td> </tr> <tr> <td>3533</td> <td>PINO FEMEA 2P+T 10A/250</td> </tr> </tbody> </table>	CÓD.	DESCRIÇÃO	3529	PINO FEMEA 2P+T 10A/250	3533	PINO FEMEA 2P+T 10A/250	<table border="1"> <thead> <tr> <th>CÓD.</th> <th>DESCRIÇÃO</th> </tr> </thead> <tbody> <tr> <td>1492</td> <td>PINO FÊMEA 2P+T 10A/250V BRANCO</td> </tr> <tr> <td>1493</td> <td>PINO FÊMEA 2P+T 20A/250V BRANCO</td> </tr> </tbody> </table>	CÓD.	DESCRIÇÃO	1492	PINO FÊMEA 2P+T 10A/250V BRANCO	1493	PINO FÊMEA 2P+T 20A/250V BRANCO	<table border="1"> <thead> <tr> <th>CÓD.</th> <th>DESCRIÇÃO</th> </tr> </thead> <tbody> <tr> <td>6469</td> <td>PINO FEMEA 2P+T 20A 250V BRANCO</td> </tr> </tbody> </table>	CÓD.	DESCRIÇÃO	6469	PINO FEMEA 2P+T 20A 250V BRANCO		
CÓD.	DESCRIÇÃO																			
3529	PINO FEMEA 2P+T 10A/250																			
3533	PINO FEMEA 2P+T 10A/250																			
CÓD.	DESCRIÇÃO																			
1492	PINO FÊMEA 2P+T 10A/250V BRANCO																			
1493	PINO FÊMEA 2P+T 20A/250V BRANCO																			
CÓD.	DESCRIÇÃO																			
6469	PINO FEMEA 2P+T 20A 250V BRANCO																			
 <p style="text-align: right;">Mec-Tronic</p>	 <p style="text-align: right;">prismaTEE</p>	 <p style="text-align: right;">Mec-Tronic</p>																		
<table border="1"> <thead> <tr> <th>CÓD.</th> <th>DESCRIÇÃO</th> </tr> </thead> <tbody> <tr> <td>5339</td> <td>PINO FÊMEA 2P 20A/250</td> </tr> </tbody> </table>	CÓD.	DESCRIÇÃO	5339	PINO FÊMEA 2P 20A/250	<table border="1"> <thead> <tr> <th>CÓD.</th> <th>DESCRIÇÃO</th> </tr> </thead> <tbody> <tr> <td>4223</td> <td>PINO POLARIZADO DE PORCELANA 20A 2 POLOS</td> </tr> <tr> <td>42244225</td> <td>PINO POLARIZADO DE PORCELANA 20A 3 POLOS</td> </tr> <tr> <td>42254226</td> <td>PINO POLARIZADO DE PORCELANA 30A 2 POLOS</td> </tr> <tr> <td>4226</td> <td>PINO POLARIZADO DE PORCELANA 30A 3 POLOS</td> </tr> </tbody> </table>	CÓD.	DESCRIÇÃO	4223	PINO POLARIZADO DE PORCELANA 20A 2 POLOS	42244225	PINO POLARIZADO DE PORCELANA 20A 3 POLOS	42254226	PINO POLARIZADO DE PORCELANA 30A 2 POLOS	4226	PINO POLARIZADO DE PORCELANA 30A 3 POLOS	<table border="1"> <thead> <tr> <th>CÓD.</th> <th>DESCRIÇÃO</th> </tr> </thead> <tbody> <tr> <td>6240</td> <td>PINO POLARIZADO DE PORCELANA 20A 2 POLOS</td> </tr> </tbody> </table>	CÓD.	DESCRIÇÃO	6240	PINO POLARIZADO DE PORCELANA 20A 2 POLOS
CÓD.	DESCRIÇÃO																			
5339	PINO FÊMEA 2P 20A/250																			
CÓD.	DESCRIÇÃO																			
4223	PINO POLARIZADO DE PORCELANA 20A 2 POLOS																			
42244225	PINO POLARIZADO DE PORCELANA 20A 3 POLOS																			
42254226	PINO POLARIZADO DE PORCELANA 30A 2 POLOS																			
4226	PINO POLARIZADO DE PORCELANA 30A 3 POLOS																			
CÓD.	DESCRIÇÃO																			
6240	PINO POLARIZADO DE PORCELANA 20A 2 POLOS																			

ELÉTRICA



CÓD.	DESCRIÇÃO
5863	TOMADA SOBREPOR INDUSTRIAL 230V 16A 2P+T 6H
5864	TOMADA SOBREPOR INDUSTRIAL 230V 32A 2P+T 6H
5865	TOMADA SOBREPOR INDUSTRIAL 400V 16A 3P+T 6H
5866	TOMADA SOBREPOR INDUSTRIAL 400V 32A 3P+T 6H



CÓD.	DESCRIÇÃO
5859	ACOPLAMENTO INDUS 230V 16A 2P+T 6H PROTEC
5860	ACOPLAMENTO INDUS 230V 32A 2P+T 6H PROTEC
5861	ACOPLAMENTO INDUS 400V 16A 3P+T 6H PROTEC
5862	ACOPLAMENTO INDUS 400V 32A 3P+T 6H PROTEC

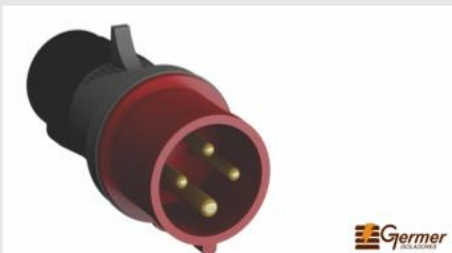

CÓD.	DESCRIÇÃO
5855	PLUG INDUS 230V 16A 2P+T 6H PROTEÇÃO IP44
5856	PLUG INDUS 230V 32A 2P+T 6H PROTEÇÃO IP44
5857	PLUG INDUS 400V 16A 3P+T 6H PROTEÇÃO IP44
5858	PLUG INDUS 400V 32A 3P+T 6H PROTEÇÃO IP44



CÓD.	DESCRIÇÃO
6239	TOMADA POLARIZADA DE PORCELANA 20A 2 POLOS



CÓD.	DESCRIÇÃO
4228	TOMADA POLARIZADA DE PORC. 20A 3 POLOS
4230	TOMADA POLARIZADA DE PORC. 30A 3 POLOS



CÓD.	DESCRIÇÃO
4227	TOMADA POLARIZADA DE PORC. 20A 2 POLOS
4229	TOMADA POLARIZADA DE PORC. 30A 2 POLOS



CÓD.	DESCRIÇÃO
7064	TOMADA EXTERNA PORCELANA 25A/250V - 3PINOS



CÓD.	DESCRIÇÃO
1784	CONECTOR DE PORCELANA 06MM - BIPOLAR
1785	CONECTOR DE PORCELANA 06MM - TRIPOLAR
1786	CONECTOR DE PORCELANA 10MM - BIPOLAR
1787	CONECTOR DE PORCELANA 10MM - TRIPOLAR
1788	CONECTOR DE PORCELANA 10MM - TRIPOLAR
1789	CONECTOR DE PORCELANA 16MM - BIPOLAR
2376	CONECTOR DE PORCELANA 16MM - TRIPOLAR



CÓD.	DESCRIÇÃO
3512	CONECTOR DE PORCELANA 06MM - BIPOLAR
3513	CONECTOR DE PORCELANA 06MM - TRIPOLAR
3514	CONECTOR DE PORCELANA 10MM - BIPOLAR
3515	CONECTOR DE PORCELANA 10MM - TRIPOLAR
3516	CONECTOR DE PORCELANA 10MM - TRIPOLAR
3517	CONECTOR DE PORCELANA 16MM - BIPOLAR
3518	CONECTOR DE PORCELANA 16MM - TRIPOLAR



CÓD.	DESCRIÇÃO
7978	CONECTOR DE PORCELANA 16MM BIPOLAR
7981	CONECTOR DE PORCELANA 10MM BIPOLAR
7983	CONECTOR DE PORCELANA 06MM BIPOLAR



CÓD.	DESCRIÇÃO
7980	CONECTOR PORCELANA 16MM TRIPOLAR
7982	CONECTOR PORCELANA 10MM TRIPOLAR
7985	CONECTOR PORCELANA 06MM TRIPOLAR



CÓD.	DESCRIÇÃO
5217	CONECTOR DE EMENDA 2 X 6MM 221-612
5216	CONECTOR DE EMENDA 5 X 4MM 221-415
5215	CONECTOR DE EMENDA 3 X 4MM 221-413
5214	CONECTOR DE EMENDA 2 X 4MM 221-412



CÓD.	DESCRIÇÃO
6467	CONECTOR DE EMENDA EM LINHA 221-2411



CÓD.	DESCRIÇÃO
5218	CON. EMENDA 2X6MM WAGO 221 (BLISTER C/3)
5219	CON. EMENDA 2X4MM WAGO 221 (BLISTER C/6)



CÓD.	DESCRIÇÃO
8990	CONECTOR DE EMENDA 2 X 4MM CÓD. 1692PC
8993	CONECTOR DE EMENDA 2 X 6MM CÓD. I32
8991	CONECTOR DE EMENDA 3 X 4MM CÓD. 1693PC
8994	CONECTOR DE EMENDA 3 X 6MM CÓD. I33
8992	CONECTOR DE EMENDA 5 X 4MM CÓD. 1695PC
8995	CONECTOR DE EMENDA 5 X 6 CÓD I35
8996	CONECTOR DE TORÇÃO GEL TWIST IP68 BLISTER

ELÉTRICA

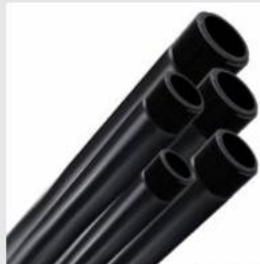

DGT

CÓD.	DESCRIÇÃO
6079	ELETRODUTO PVC RIGIDO 1 ROSC PRETO 3MT DGT
6080	ELETRODUTO PVC RIGIDO 1.1/2 ROSC PTO. 3MT DGT
5230	ELETRODUTO PVC RIGIDO 1/2 ROSC PRETO 3MT DGT
5231	ELETRODUTO PVC RIGIDO 3/4 ROSC PRETO 3MT DGT



CÓD.	DESCRIÇÃO
7237	CAIXA DE ATERRAMENTO MEDIA ONCA



R R Pimmel

CÓD.	DESCRIÇÃO
3789	CONECTOR METALICO 06MM SPLIT BOLT
3790379	CONECTOR METALICO 10MM SPLIT BOLT
3791379	CONECTOR METALICO 16MM SPLIT BOLT
3792379	CONECTOR METALICO 25MM SPLIT BOLT
3793379	CONECTOR METALICO 35MM SPLIT BOLT
3794	CONECTOR METALICO 50MM SPLIT BOLT



R R Pimmel

CÓD.	DESCRIÇÃO
4603	CONECTOR METALICO 70MM SPLIT BOLT
4604460	CONECTOR METALICO 95MM SPLIT BOLT
4605	CONECTOR METALICO 120MM SPLIT BOLT



CÓD.	DESCRIÇÃO
7184	CONECTOR DERIVACAO PERF. 70MM
7185	CONECTOR DERIVACAO PERF. 120MM - 35MM
7186	CONECTOR DERIVACAO PERF. 120MM - 120MM



R R Pimmel

CÓD.	DESCRIÇÃO
3784	TERMINAL PRESSAO 16MM (BOTINHA)
3785	TERMINAL PRESSAO 25MM (BOTINHA)



CÓD.	DESCRIÇÃO
6085	GRAMPO ATERR. P/ HASTE 1/2 A 3/4 COBRE FERRO



R R Pimmel

CÓD.	DESCRIÇÃO
4606	TERMINAL DE COMPRESSÃO 10MM
46074608	TERMINAL DE COMPRESSÃO 16MM
46084609	TERMINAL DE COMPRESSÃO 25MM
46094610	TERMINAL DE COMPRESSÃO 35MM
4610	TERMINAL DE COMPRESSÃO 50MM



CÓD.	DESCRIÇÃO
6234	EMENDA COAXIAL F+F



R R Pimmel

CÓD.	DESCRIÇÃO
3786	TERMINAL TUBULAR ILHOS 06MM LONGO
3787378	TERMINAL TUBULAR ILHOS 10MM LONGO
3788	TERMINAL TUBULAR ILHOS 16MM LONGO



BOMVINK

CÓD.	DESCRIÇÃO
8463	KIT TERMINAIS TUBULAR ILHOS 800 PEÇAS



BOMVINK

CÓD.	DESCRIÇÃO
8462	KIT TERMINAIS GARFO E OLHAL 320 PEÇAS



BOMVINK

CÓD.	DESCRIÇÃO
8333	ALICATE PRENSA TERMINAIS 0,25 A 10MM



BOMVINK

CÓD.	DESCRIÇÃO
8439	ALICATE DECAPADOR DE FIO



BOMVINK

CÓD.	DESCRIÇÃO
8151	ALICATE PARA DESCASCAR FIOS E CABOS

ELÉTRICA

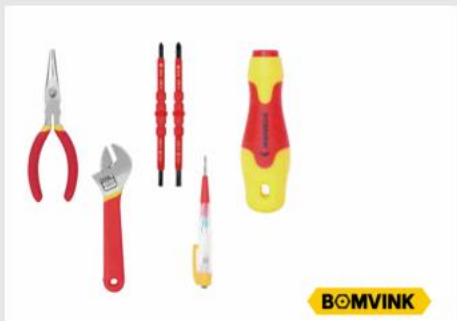

BOMVINK

CÓD. DESCRIÇÃO
8356 KIT FERRAMENTAS 6 PEÇAS ISOLADA ELETRICISTA



BOMVINK

CÓD. DESCRIÇÃO
8348 JOGO DE CHAVES ISOLADAS ELETRICISTA 6 PEÇAS



BOMVINK

CÓD. DESCRIÇÃO
8497 KIT CHAVE FENDA/PHILIPS 15 EM 1 ISOL. ELETRICISTA



ACESSÓRIOS:
PONTAS DE PROVA x 1

BOMVINK

CÓD. DESCRIÇÃO
8132 ALICATE AMPERÍMETRO DIGITAL



THOMPSON

CÓD. DESCRIÇÃO
1872 ALICATE AMPERIMETRO



ACESSÓRIOS:
PONTAS DE PROVA x 1

BOMVINK

CÓD. DESCRIÇÃO
8131 MULTÍMETRO DIGITAL



THOMPSON

CÓD. DESCRIÇÃO
1898 MULTIMETRO DIGITAL



ACESSÓRIOS:
PONTAS DE PROVA x 1

BOMVINK

CÓD. DESCRIÇÃO
8671 MULTIMETRO DIGITAL PREMIUM



BOMVINK

CÓD. DESCRIÇÃO
8484 TIMER ANALÓGICO BIVOLT



THOMPSON

CÓD. DESCRIÇÃO
7369 TIMER ANALÓGICO BIVOLT



THOMPSON

CÓD. DESCRIÇÃO
3329 TIMER DIGITAL BIVOLT



BOMVINK

CÓD. DESCRIÇÃO
9021 TIMER DIGITAL BIVOLT



THOMPSON

CÓD. DESCRIÇÃO
3341 TESTE DE VOLTAGEM 3 EM 1 (110V A 500V)



THOMPSON

CÓD. DESCRIÇÃO
3338 CHAVE TESTE ANALÓGICO 135 MM
3339 CHAVE TESTE ANALÓGICO 165MM (MAIOR)



BOMVINK

CÓD. DESCRIÇÃO
8596 DETECTOR DE TENSÃO 90A 1000V

ELÉTRICA



OMEGA
IMPORTADORA

CÓD.	DESCRIÇÃO
1548	CHAVE TESTE DIGITAL



OMEGA
IMPORTADORA

CÓD.	DESCRIÇÃO
2092	CHAVE TESTE ANALÓGICO



THOMPSON

CÓD.	DESCRIÇÃO
3340	CHAVE TESTE DIGITAL



Mec-Tronic

CÓD.	DESCRIÇÃO
6232	TOMADA EM BARRA 3 SAIDAS 10A 2P+T 250V
6233	TOMADA EM BARRA 3 SAIDAS 10A 2P 250V



PRISMATEC

CÓD.	DESCRIÇÃO
3526	EXTENSÃO 1,5M CABO PARAL 10A/250V
3523	EXTENSÃO 3M CABO PARAL 10A/250V
3524	EXTENSÃO 5M CABO PARAL 10A/250V
3525	EXTENSÃO 10M CABO PARAL 10A/250V



MEGATRON
FIO E CABOS ESPECIALIZADOS

CÓD.	DESCRIÇÃO
7253	EXTENSÃO 1,5M CABO PARAL. 10A/250V
5323	EXTENSÃO 3M CABO PARALELO 10A/250V
5324	EXTENSÃO 5M CABO PARALELO 10A/250V
5325	EXTENSÃO 10M CABO PARALELO 10A/250V



Mec-Tronic

CÓD.	DESCRIÇÃO
5832	EXTENSÃO 2M CABO PARAL. 10A/250V - MINI
29972998	EXTENSÃO 3M 2P C-P 2X0,75 10A/250V - MINI
29982999	EXTENSÃO 5M 2P C-P 2X0,75 10A/250V - MINI
29995833	EXTENSÃO 10M 2P C-P 2X0,75 10A/250V - MINI
5833	EXTENSÃO 5M 2P+T C/CABO FLEX PP

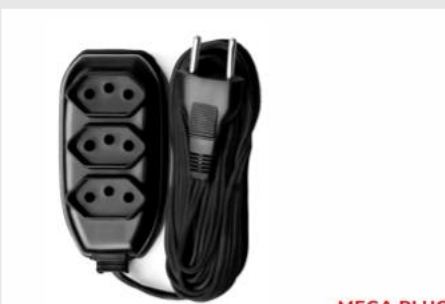

MEGA PLUG

CÓD.	DESCRIÇÃO
7241	EXTENSÃO 2M CABO PARAL. TOMADA MULTIPLA



Canaã

CÓD.	DESCRIÇÃO
7372	FILTRO DE LINHA 5 TOMADAS C/FUSIVEL BIV.



MEGATRON
FIO E CABOS ESPECIALIZADOS

CÓD.	DESCRIÇÃO
6706	FILTRO DE LINHA 5 TOMADAS C/FUSIVEL BIV.



OPL
ILUMINAÇÃO

CÓD.	DESCRIÇÃO
6647	TRANSFORMADOR 300VA - 110 220 OU 220 110
7347	TRANSFORMADOR 500VA - 110 220 OU 220 110
6648	TRANSFORMADOR 800VA - 110 220 OU 220 110
6649	TRANSFORMADOR 2000VA - 110 220 OU 220 110
6650	TRANSFORMADOR 5000VA - 110 220 OU 220 110
6655	TRANSFORMADOR 1500VA - 110 220 OU 220 110
6657	TRANSFORMADOR 1010VA - 110 220 OU 220 110
6658	TRANSFORMADOR 3000VA - 110 220 OU 220 110



Kitec
EQUIPAMENTOS DE AUTOMATIZAÇÃO

CÓD.	DESCRIÇÃO
5071	TRANSFORMADOR 500VA - 110 220 OU 220 110
5072	TRANSFORMADOR 750VA - 110 220 OU 220 110
5074	TRANSFORMADOR 1500VA - 110 220 OU 220 110



MG
MARGIRIUS

CÓD.	DESCRIÇÃO
3089	LED DRIVER 8-25W 300MA CONECTOR



PRISMATEC

CÓD.	DESCRIÇÃO
3519	EXTENSÃO 1,5M 2P+T C/CABO FLEX PP - PRISMATEC
3852	EXTENSÃO 3M 2P+T C/CABO FLEX PP - PRISMATEC
3520	EXTENSÃO 5M 2P+T C/CABO FLEX PP - PRISMATEC
3521	EXTENSÃO 10M 2P+T C/CABO FLEX PP - PRISMATEC
4512	CABO PROLONGADOR 3M 10A/250V BR - PRISMATEC
4513	CABO PROLONGADOR 5M 10A/250V BR - PRISMATEC

ELÉTRICA



CÓD.	DESCRIÇÃO
2959	PASSA FIO 10 M
29602961	PASSA FIO 15 M
29612962	PASSA FIO 20 M
29622963	PASSA FIO 30 M
2963	PASSA FIO 40 M



CÓD.	DESCRIÇÃO
2954	PASSA FIO 10M C/ ALMA DE AÇO
29552956	PASSA FIO 15M C/ ALMA DE AÇO
29562957	PASSA FIO 20M C/ ALMA DE AÇO
29572958	PASSA FIO 30M C/ ALMA DE AÇO
2958	PASSA FIO 40M C/ ALMA DE AÇO



CÓD.	DESCRIÇÃO
6387	PASSA FIO 10M C/ ALMA ACO
63886389	PASSA FIO 15M C/ ALMA ACO
6389	PASSA FIO 20M C/ ALMA ACO



CÓD.	DESCRIÇÃO
7885	PASSA FIO HELICOIDAL 10M
7886	PASSA FIO HELICOIDAL 15M
7887	PASSA FIO HELICOIDAL 20M
7888	PASSA FIO HELICOIDAL 30M



CÓD.	DESCRIÇÃO
7994	PASSA FIO 10M COM ALMA AÇO
79957996	PASSA FIO 15M COM ALMA AÇO
7996	PASSA FIO 20M COM ALMA AÇO



CÓD.	DESCRIÇÃO
5312	PASSA FIO 10M C/ ALMA DE ACO
5313	PASSA FIO 15M C/ ALMA DE ACO
5314	PASSA FIO 20M C/ ALMA DE ACO
5321	PASSA FIO 30M C/ ALMA DE ACO
5322	PASSA FIO 50M C/ ALMA DE ACO
5315	PASSA FIO 10M
5316	PASSA FIO 15M
5317	PASSA FIO 20M



CÓD.	DESCRIÇÃO
1328	ROLDANA PVC 24X24 C/ PREGO RIBEIRO
1329	ROLDANA PVC 30X30 C/ PREGO RIBEIRO
1330	ROLDANA PVC 36X36 C/ PREGO RIBEIRO



CÓD.	DESCRIÇÃO
5784	ISOLADOR PORCELANA OLHAL PIMENTAO



CÓD.	DESCRIÇÃO
7622	ISOLADOR PIMENTÃO PORCELANA OLHAL



CÓD.	DESCRIÇÃO
4232	ISOLADOR PORCELANA OLHAL PIMENTÃO



CÓD.	DESCRIÇÃO
7986	ISOLADOR TIPO OLHAL 70X50X38MM-5/16



CÓD.	DESCRIÇÃO
5783	ISOLADOR PORCELANA ROLDANA 72X72



CÓD.	DESCRIÇÃO
4231	ISOLADOR PORCELANA ROLDANA 72 x 72



CÓD.	DESCRIÇÃO
7623	ISOLADOR ROLDANA PORCELANA 54X57MM



CÓD.	DESCRIÇÃO
7987	ISOLADOR TIPO ROLDANA 72 X 72MM

ELÉTRICA



prismatec

CÓD. DESCRIÇÃO
3511 RECEPTACULO PORCELANA



THOMPSON

CÓD. DESCRIÇÃO
1789 RECEPTÁCULO PORCELANA PLAFON TH50
1790 RECEPTÁCULO PORCELANA PLAFON TH51



Germer
SOLUCIONES
"Tratando con Intelecto de Energía"

CÓD. DESCRIÇÃO
7975 RECEPTÁCULO PORCELANA



THOMPSON

CÓD. DESCRIÇÃO
3326 SOQUETE NYLON SEM CHAVE



Mec-Tronic

CÓD. DESCRIÇÃO
6237 SOQUETE DE ABAJUR 4A/250V BRANCO
6238 SOQUETE DE ABAJUR 4A/250V PRETO



THOMPSON

CÓD. DESCRIÇÃO
3328 SOQUETE FIXO DE TETO



prismatec

CÓD. DESCRIÇÃO
3510 SOQUETE C/ RABICHO

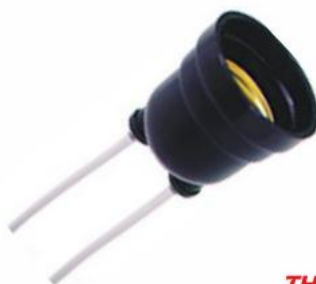

THOMPSON

CÓD. DESCRIÇÃO
3325 SOQUETE C/RABICHO



Germer
SOLUCIONES
"Tratando con Intelecto de Energía"

CÓD. DESCRIÇÃO
7976 SOQUETE COM RABICHO 4A/250V PRETO
7977 SOQUETE COM RABICHO 4A/250V BRANCO



Mec-Tronic

CÓD. DESCRIÇÃO
6236 SOQUETE C/ RABICHO 4A/250V



Germer
SOLUCIONES
"Tratando con Intelecto de Energía"

CÓD. DESCRIÇÃO
7974 SOQUETE COM RABICHO EMBORRACHADO



prismatec

CÓD. DESCRIÇÃO
3801 SOQUETE C/ CHAVE



Germer
SOLUCIONES
"Tratando con Intelecto de Energía"

CÓD. DESCRIÇÃO
7973 SOQUETE PINO PORTA LÂMPADA 250V 4A



THOMPSON

CÓD. DESCRIÇÃO
3327 SOQUETE COM PLUG (PINO PORTA LAMPADA)



prismatec

CÓD. DESCRIÇÃO
7704 SOQUETE COM RABICHO PARA LÂMPADA TUBULAR
4514 SOQUETE P/ LÂMPADA DICROICA Gu10

ELÉTRICA



CÓD. DESCRIÇÃO
7652 SENSOR DE PRESENÇA 180 INTERNO BRANCO



CÓD. DESCRIÇÃO
7649 SENSOR DE PRESENÇA 360 INTERNO BRANCO



CÓD. DESCRIÇÃO
2969 SENSOR PRES PAR. SOBR BRA. C/FOTOCEL. MPS-40F
2970 SENSOR PRES PAR. SOBR PRE. C/FOTOCEL. MPS-40F



CÓD. DESCRIÇÃO
7651 SENSOR DE PRESENÇA 180 EXTERNO PRETO



CÓD. DESCRIÇÃO
2967 SENSOR PRES EXTERNO BR C/FOTOCELULA MPX-40F



CÓD. DESCRIÇÃO
2968 SENSOR DE TETO EMBUTIR C/ FOTOCELULA



CÓD. DESCRIÇÃO
7708 SENSOR DE PRESENÇA EMB. OU SOBR 360 GRAUS



CÓD. DESCRIÇÃO
7650 SENSOR DE PRESENÇA EMBUTIR E SOBR 360 GRAUS



CÓD. DESCRIÇÃO
7653 SENSOR PRESENÇA EMBUTIR CAIXINHA 4X2 PRETO
7654 SENSOR PRESENÇA EMBUTIR CAIXINHA 4X2 BRANCO



CÓD. DESCRIÇÃO
2971 SENSOR DE PRESENÇA PAREDE EMBUTIR



CÓD. DESCRIÇÃO
7642 SENSOR DE PRES. C/BOCAL E27 360 GRAUS C/ FOTO.



CÓD. DESCRIÇÃO
3013 SENSOR PRES. AJUST SOQUETE E27 C/FOTOCELULA



CÓD. DESCRIÇÃO
2975 RELE FOTOELET. C/PROT 1000W BIV RFE-130
3088 RELE FOTOELET. C/PROT 1000W BIV CONEC RFE-131



CÓD. DESCRIÇÃO
2978 RELE FOTOELET. TEMPORI.. PROG BIVOLT RFE-70



CÓD. DESCRIÇÃO
7707 RELE FOTOCÉLULA CONTATO N.A QR53

ELÉTRICA



CÓD. DESCRIÇÃO
7645 RELE FOTOCÉLULA CORUJITO



CÓD. DESCRIÇÃO
2974 RELE FOTOELET. COMPACTO 500W BIVOLT RFE-10



CÓD. DESCRIÇÃO
2977 TOMADA P/ RELE SUPORTE METALICO BIV Bs1



CÓD. DESCRIÇÃO
2976 TOMADA P/ RELE SUPORTE PLASTICO BIV Bs2



CÓD. DESCRIÇÃO
6299 CHAVE BOIA UNIPOLAR 25A BIVOLT CB 1,5MT
2979 CHAVE BOIA UNIPOLAR 15A BIVOLT CB 1,5MT



CÓD. DESCRIÇÃO
8775 CHAVE BOIA UNIPOLAR 16A BIVOLT CB 1,2MT



CÓD. DESCRIÇÃO
8658 CHAVE MONOFÁSICA REVERSORA 20 AMP
8659 CHAVE MONOFÁSICA REVERSORA 30 AMP.
8654 CHAVE MONOFÁSICA SIMPLES 20 AMP.
8655 CHAVE MONOFÁSICA SIMPLES 45 AMP.
8657 CHAVE MONOFÁSICA SIMPLES 60 AMP.
8660 CHAVE MONOFÁSICA REVERSORA 45 AMP.
8661 CHAVE MONOFÁSICA REVERSORA 60 AMP.
8666 CHAVE TRIFÁSICA REVERSORA 20 AMP.
8667 CHAVE TRIFÁSICA REVERSORA 30 AMP.
8668 CHAVE TRIFÁSICA REVERSORA 45 AMP.
8669 CHAVE TRIFÁSICA REVERSORA 60 AMP.
8662 CHAVE TRIFÁSICA SIMPLES 20 AMP
8663 CHAVE TRIFÁSICA SIMPLES 30 AMP.
8664 CHAVE TRIFÁSICA SIMPLES 45 AMP.
8665 CHAVE TRIFÁSICA SIMPLES 60 AMP.



CÓD. DESCRIÇÃO
7339 BOMBA SUBMERSA SAPO SAPECA 127V
7343 BOMBA SUBMERSA SAPO SAPECA 220V



CÓD. DESCRIÇÃO
7340 BOMBA SUBMERSA SAPO 750 FIRE 127V
7344 BOMBA SUBMERSA SAPO 750 FIRE 220V



CÓD. DESCRIÇÃO
7341 BOMBA SUBMERSA SAPO 850 FIRE 127V
7345 BOMBA SUBMERSA SAPO 850 FIRE 220V



CÓD. DESCRIÇÃO
9038 BOMBA TURBO 1500 127V
9039 BOMBA TURBO 1500 220V
9040 BOMBA TURBO 2000 127V
9041 BOMBA TURBO 2000 220V



CÓD. DESCRIÇÃO
6082 HASTE DE ATERR COBRE 1/2 X 2,40MT COBREFERRO
6083 HASTE DE ATERR COBRE 1/2 X 1,50MT COBREFERRO
6084 HASTE DE ATERR COBRE 5/8 X 2,40MT COBREFERRO

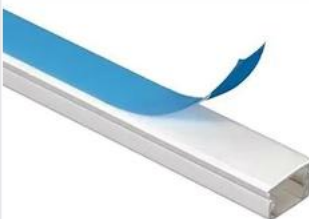

CÓD. DESCRIÇÃO
7797 CANALETA 20X10X2000 S/D BRANCO+FITA FORTE



CÓD. DESCRIÇÃO
9024 CANALETA 20X10X2000 S/D BRANCO+FITA FORTE

ELÉTRICA



Bestfer

CÓD.	DESCRIÇÃO
7631	ANTENA DIGITAL HDTV INTERNA 20CM IMA 3M



hydra

CÓD.	DESCRIÇÃO
1740	DUCHA GORDUCHA 4T 110V
1741	DUCHA GORDUCHA 4T 220V



hydra

CÓD.	DESCRIÇÃO
7969	DUCHA MINHA DUCHA MULT 4T 6200W 220V
7970	DUCHA MINHA DUCHA MULT 4T 5500W 110V



Zagonel

CÓD.	DESCRIÇÃO
8064	DUCHA IDEALE PLUS 4T 5500W 110V
8065	DUCHA IDEALE PLUS 4T 6800W 220V



LORENZETTI

CÓD.	DESCRIÇÃO
28262818	DUCHA MAXIDUCHA 5500W 110V
28188652	DUCHA MAXIDUCHA 5500W 220V
8652	DUCHA MAXIDUCHA 4600W 127V



LORENZETTI

CÓD.	DESCRIÇÃO
2828	DUCHA BELLADUCHA 5500W 127V 4T
2827	DUCHA BELLADUCHA 6800W 220V 4T



LORENZETTI

CÓD.	DESCRIÇÃO
5800	DUCHA LOREN SHOWER ELETRONICA 110V 5500W
5801	DUCHA LOREN SHOWER ELETRONICA 220V 7500W



LORENZETTI

CÓD.	DESCRIÇÃO
28192820	DUCHA ADVANCED 7500W 220V
2820	DUCHA ADVANCED 5500W 110V



Zagonel

CÓD.	DESCRIÇÃO
8054	DUCHA SUBLIME ELETRÔNICA 110V 5500W
8055	DUCHA SUBLIME ELETRÔNICA 220V 7500W



Zagonel

CÓD.	DESCRIÇÃO
8056	DUCHA MOMENT ELETRÔNICA 110V 5500W
8057	DUCHA MOMENT ELETRÔNICA 220V 7500W



Zagonel

CÓD.	DESCRIÇÃO
8058	DUCHA MOMENT 4 TEMP. 110V 5500W
8059	DUCHA MOMENT 4 TEMP. 220V 7500W



Zagonel

CÓD.	DESCRIÇÃO
8060	DUCHA DUCALI ELETR. 110V 5500W
8061	DUCHA DUCALI ELETR. 220V 7500W



hydra corona

CÓD.	DESCRIÇÃO
16561657	DUCHA SS 110V 5400W
1657	DUCHA SS 220V 5200W



Zagonel

CÓD.	DESCRIÇÃO
8062	DUCHA MASTER BANHO ELETR. 110V 5500W
8063	DUCHA MASTER BANHO ELETR. 220V 7500W



Zagonel

CÓD.	DESCRIÇÃO
8068	RESIST DUCHA M. ELETRON. SUB. M. 5500W 110V
8069	RESIST DUCHA M. ELETRON. SUB. M. 7500W 220V

ELÉTRICA



TORNEIRA

Zaganel

CÓD.	DESCRIÇÃO
8070	RESIST. DUCHA MOM. 4T. TORN. LUNA 110V 5500W
8076	RESIST. TORNEIRA LUNA 220V 5500W



hydra
corona

CÓD.	DESCRIÇÃO
1668	RESIST. DUCHA GORD. 4T 110V
1669	RESIST. DUCHA GORD. 4T 220V



PRATIMIX

CÓD.	DESCRIÇÃO
2857	RESIST. DUCHA SS BALLERINA 127V
2858	RESIST. DUCHA SS BALLERINA 220V



hydra
corona

CÓD.	DESCRIÇÃO
1666	RESIST. DUCHA SS BALLERINA 110V
1667	RESIST. DUCHA SS BALLERINA 220V



PRATIMIX

CÓD.	DESCRIÇÃO
2855	RESIST. DUCHA GORDUCHA 4T 127V
2856	RESIST. DUCHA GORDUCHA 4T 220V
59075	RESIST DUCHA GORDUCHA 3T/BANHAO 5400W 220V
5908	RESIST DUCHA GORDUCHA 3T/BANHAO 5400W 127V



hydra
corona

CÓD.	DESCRIÇÃO
1751	RESIST. HYDRA. 4T 5500W - 127V
1752	RESIST. HYDRA. 4T 5500W - 220V



Eletrplas

CÓD.	DESCRIÇÃO
8793	RESIST. LOREN SHOWER 127V
8794	RESIST. LOREN SHOWER 220V



PRATIMIX

CÓD.	DESCRIÇÃO
3857	RESIST DUCHA OPTIMA 8T 127V
3858	RESIST DUCHA OPTIMA 8T 220V



PRATIMIX

CÓD.	DESCRIÇÃO
2849	RESIST. MAXI/BELO/RELAX 5500W 127V
2850	RESIST. MAXI/BELO/RELAX 5500W 220V



LORENZETTI

CÓD.	DESCRIÇÃO
2831	RESIST MAXI DUCHA 127V/5500W REF 055 J
2832	RESIST MAXI DUCHA 220V/5500W REF 055 A



PRATIMIX

CÓD.	DESCRIÇÃO
3855	RESIST DUO SHOWER 127V 5500W TIPO L
3856	RESIST DUO SHOWER 220V 6800W TIPO L



Eletrplas

CÓD.	DESCRIÇÃO
5598	RESIST MAXI DUCHA 5500W 127V
5599	RESIST MAXI DUCHA 5500W 220V



PRATIMIX

CÓD.	DESCRIÇÃO
7714	RESISTÊNCIA LOREN SHOWER 110V 5500W
7715	RESISTÊNCIA LOREN SHOWER 220V 6800W



ASTRA

CÓD.	DESCRIÇÃO
4542	RESIST MAXI/BELO/RELAX 5500W 127V
4543	RESIST MAXI/BELO/RELAX 5500W 220V REL32V2M



LORENZETTI

CÓD.	DESCRIÇÃO
4779	RESIST ULTRA MAXI DUCHA 5500W 127V
4780	RESIST ULTRA MAXI DUCHA 5500W 220V

ELÉTRICA



LORENZETTI

CÓD.	DESCRIÇÃO
5281	RESIST BELLA DUCHA ULTRA 4T 3065E 6800W 220V
5282	RESIST BELLA DUCHA ULTRA 4T 3065F 5500W 127V



PRATIMIX

CÓD.	DESCRIÇÃO
8154	RESIST ULTRA MAXI DUCHA 5500W 220V
7583	RESIST ULTRA MAXI DUCHA 5500W 110V



Eletroplas

CÓD.	DESCRIÇÃO
5596	RESIST BELLA DUCHA 4T 5500W 127V C/SUP.
5597	RESIST BELLA DUCHA 4T 6800W 220V C/SUP.



Zagonel

CÓD.	DESCRIÇÃO
8074	RESIST DUCHA IDEALE PLUS/FLUIR 110V 5500W
8075	RESIST DUCHA IDEALE PLUS/FLUIR 220V 6800W



PRATIMIX

CÓD.	DESCRIÇÃO
2851	RESIST. BELLA/FASHION 5500W/127V C/SUP.
2852	RESIST BELLA/FASHION 6800W 220V C/SUPORTE



PRATIMIX

CÓD.	DESCRIÇÃO
3853	RESIST FIT ELETRONICA 127V 5500W
3854	RESIST FIT ELETRONICA 220V 6800W HYF0255



LORENZETTI

CÓD.	DESCRIÇÃO
2829	RESIST. BELLA/FASHION 5500W 127V
2830	RESIST BELLA/FASHION 220V/6800 REF 3056



hydra

CÓD.	DESCRIÇÃO
5816	RES DUCH OPTIMA ELETRON/STAR/ND 5500W 127V
5817	RES DUCH OPTIMA ELETRON/STAR/ND 7700W 220V



hydra
corona

CÓD.	DESCRIÇÃO
6477	RESISTENCIA ND ELETRONICA 220V 7700W
6478	RESISTENCIA ND ELETRONICA 127V 5500W



Eletroplas

CÓD.	DESCRIÇÃO
7126	RESIST ADVANCED/TOPIJET 5500W 127V
7134	RESIST ADVANCED/TOPIJET 7500W 220V

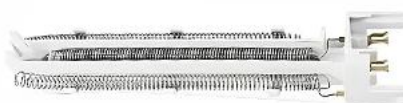

LORENZETTI

CÓD.	DESCRIÇÃO
2833	RESIST ADVANCED/TOPIJET 127V REF 3055 Q
2834	RESIST ADVANCED/TOPIJET 220V REF 3055 O



PRATIMIX

CÓD.	DESCRIÇÃO
2853	RESIST. ADVANCED/TOPIJET 5500W 127V
2854	RESIST. ADVANCED/TOPIJET 5500W 220V
5076	RESIST ADVANCED ELETRONICA 127V 5500W
5077	RESIST ADVANCED ELETRONICA 220V 7500W



PRATIMIX

CÓD.	DESCRIÇÃO
5076	RESIST ADVANCED ELETR. 110V 5500W
5077	RESIST. ADVANCED ELETR. 220V 7500W



Zagonel

CÓD.	DESCRIÇÃO
8070	RESIST. DUCHA MOMENT 4T 110V 5500W
8071	RESIST. DUCHA MOMENT 4T 220V 6800W



PRATIMIX

CÓD.	DESCRIÇÃO
8865	RESIST. ACQUA ELETRONICA 220V 7800W
8864	RESIST. ACQUA ELETRONICA 127V 5500W

ELÉTRICA



Zagonel

CÓD.	DESCRIÇÃO
8072	RESIST. DUCHA DUCALI 110V 5500W
8073	RESIST. DUCHA DUCALI 220V 7500W



MAXXY

CÓD.	DESCRIÇÃO
7144	LAMP LED 9W MAXXY BIV 6500K
7267	LAMP LED 12W MAXXY BIV 6500K 7268
7268	LAMP LED 15W MAXXY BIV 6500K



UP LED

CÓD.	DESCRIÇÃO
7754	LÂMPADA LED 9W UP LED BIVOLT 6500K
7755	LÂMPADA LED 12W UP LED BIVOLT 6500K
7756	LÂMPADA LED 15W UP LED BIVOLT 6500K
7757	LÂMPADA LED 20W UP LED BIVOLT 6500K
7758	LÂMPADA LED 30W UP LED BIVOLT 6500K
7759	LÂMPADA LED 40W UP LED BIVOLT 6500K



TechLUZ
LÂMPADAS

CÓD.	DESCRIÇÃO
4463	LÂMPADA LED 09W 6500K BIVOLT
4362	LÂMPADA LED 12W 6500K BIVOLT
4574	LÂMPADA LED 15W 6500K BIVOLT



MAXXY

CÓD.	DESCRIÇÃO
7145	LAMP LED 20W MAXXY BIV 6500K7146
7146	LAMP LED 30W MAXXY BIV 6500K7286
7286	LAMP LED 40W MAXXY BIV 6500K 7147
7147	LAMP LED 50W MAXXY BIV 6500K



GALAXY
LED

CÓD.	DESCRIÇÃO
7431	LAMP LED 20W GALAXY BIV 6500K
7432	LAMP LED 30W MAXXY BIV 6500K GALAXY BIV 6500K7454
7454	LAMP LED 50W MAXXY BIV 6500K GALAXY BIV 6500K7455
7455	LAMP LED 50W GALAXY BIV 6500K



TechLUZ
LÂMPADAS

CÓD.	DESCRIÇÃO
4310	LÂMPADA LED 20W ALTA POTÊNCIA BIVOLT 6500K
4311	LÂMPADA LED 30W ALTA POTÊNCIA BIVOLT 6500K
4312	LÂMPADA LED 40W ALTA POTÊNCIA BIVOLT 6500K
4363	LÂMPADA LED 50W ALTA POTÊNCIA BIVOLT 6500K
82718272	LÂMPADA LED 65W ALTA POTÊNCIA BIVOLT 6500K
8272682726	LÂMPADA LED 85W ALTA POTÊNCIA BIVOLT 6500K
8277	LÂMPADA LED 100W ALTA POTÊNCIA BIVOLT 6500K



UP LED

CÓD.	DESCRIÇÃO
7889	LAMPADA LED 50W BIVOLT 6500K



kian
ILUMINAÇÃO

CÓD.	DESCRIÇÃO
6371	LAMP LED 65W INDUSTRIAL BULBO 6500K



MAXXY

CÓD.	DESCRIÇÃO
8780	LAMP LED 12W 3000K BRANCO MORNO(AMAR.)
8781	LAMP LED 15W 3000K BRANCO MORNO(AMAR.)



TechLUZ
LÂMPADAS

CÓD.	DESCRIÇÃO
8829	LAMP LED 20W 3000K BRANCO QUENTE
8828	LAMP LED 15W 3000K BRANCO QUENTE
8827	LAMP LED 9W 3000K BRANCO QUENTE



kian
ILUMINAÇÃO

CÓD.	DESCRIÇÃO
5179	LAMP HALOGENA CLARA 42W 220V ECOLOGENA



THOMPSON

CÓD.	DESCRIÇÃO
3331	LAMP BOLINHA INC. 7W - 127V E27 SORTIDA
3330	LAMP BOLINHA INC. 15W - 127V E27 SORTIDA



THOMPSON

CÓD.	DESCRIÇÃO
3333	LAMP GELADEIRA/MICRO 15W - E14 - 110V TRANSP.



THOMPSON

CÓD.	DESCRIÇÃO
3332	LAMP GELADEIRA/FOGAO 40W - E27 110V TRANSP.

ELÉTRICA



CÓD. DESCRIÇÃO
8555 LAMP LED TUBULAR 18W T8 6500K BIVOLT



CÓD. DESCRIÇÃO
7162 LUMINARIA LED EMB QD 18W 6,500K MAXXY
7163 LUMINARIA LED EMB QD 24W 6,500K MAXXY



CÓD. DESCRIÇÃO
7911 LUMINÁRIA LED EMBUTIR 24W 6500K QD BIV
7912 LUMINÁRIA LED EMBUTIR 18W 6500K QD BIV



CÓD. DESCRIÇÃO
5739 LUM. LED EMBUTIR 24W 6500K QD. BIVOLT
5738 LUM. LED EMBUTIR 18W 6500K QD. BIVOLT
8831 LUM. LED EMBUTIR 12W 6.500K QD. BIVOLT



CÓD. DESCRIÇÃO
7766 LUMINÁRIA LED SOBREPÔR 18W 6500K QD BIVOLT
7767 LUMINÁRIA LED SOBREPÔR 24W 6500K QD BIVOLT
7799 LUMINÁRIA LED SOBREPÔR 12W 6500K QD BIVOLT



CÓD. DESCRIÇÃO
5736 LUM. LED SOBREPÔR 18W 6500K QD. BIVOLT
5737 LIM. LED. SOBREPÔR 24W 6500K QD. BIVOLT



CÓD. DESCRIÇÃO
7148 LUMINARIA LED SOB QD 18W 6,500K MAXXY
7164 LUMINARIA LED SOB QD 24W 6,500K MAXXY



CÓD. DESCRIÇÃO
6205 LUMINARIA LED EMB QD 03W MR11 6,0



CÓD. DESCRIÇÃO
8153 LUM. SPOT EMBUTIR QD. 5W 6500K BIVOLT



CÓD. DESCRIÇÃO
7791 REFLETOR LED 50W PRETO 6500K BIVOLT
7792 REFLETOR LED 100W PRETO 6500K BIVOLT
7793 REFLETOR LED 200W PRETO 6500K BIVOLT
7794 REFLETOR LED 300W PRETO 6500K BIVOLT
7795 REFLETOR LED 400W PRETO 6500K BIVOLT



CÓD. DESCRIÇÃO
8542 REFLETOR LED 50W PRETO 6500K BIV
7132 REFLETOR LED 100W PRETO 6500K BIV
7127 REFLETOR LED 150W PRETO 6500K BIV
7128 REFLETOR LED 200W PRETO 6500K BIV
7220 REFLETOR LED 300W PRETO 6500K BIV
7511 REFLETOR LED 400W PRETO 6500K BIV
8096 REFLETOR LED 500W PRETO 6500K BIV



CÓD. DESCRIÇÃO
7760 REFLETOR LED 30W PRETO IP66 6500K BIVOLT
7761 REFLETOR LED 50W PRETO IP66 6500K BIVOLT
7762 REFLETOR LED 100W PRETO IP66 6500K BIVOLT
7763 REFLETOR LED 150W PRETO IP66 6500K BIVOLT
7764 REFLETOR LED 200W PRETO IP66 6500K BIVOLT
7765 REFLETOR LED 300W PRETO IP66 6500K BIVOLT



CÓD. DESCRIÇÃO
8263 LUM. LED SOLAR 100W RECARREGÁVEL C/ SUPORTE



CÓD. DESCRIÇÃO
8358 LUM. LED SOLAR 75W RECARREGÁVEL C/ SUPORTE

ELÉTRICA



LED×8

BOMVINK

CÓD. DESCRIÇÃO
8266 KIT 2 LUM. SOLAR VAGALUME 8 LEDS ESP. JARDIM



LED×10

BOMVINK

CÓD. DESCRIÇÃO
8267 KIT 2 LUM. SOLAR VAGALUME 10 LEDS ESP. JARDIM



LED×6

BOMVINK

CÓD. DESCRIÇÃO
8265 KIT 2 LUM. SOLAR VAGALUME 6 LEDS ESP. JARDIM



CÓD. DESCRIÇÃO
7938 LUMINÁRIA TARTARUGA 15W BRANCA 6500K IP65
7939 LUMINÁRIA TARTARUGA 15W PRETA 6500K Ip65
7940 LUMINÁRIA TARTARUGA 5W BRANCA 6500K Ip65
7941 LUMINÁRIA TARTARUGA 8W BRANCA 6500K IP65
7942 LUMINÁRIA TARTARUGA 8W PRETA 6500K IP65



BELLA VIDROS

CÓD. DESCRIÇÃO
2700 LUMINARIA TAR. BRANCA FERRO/VIDRO
2701 LUMINARIA TAR. PRETA FERRO/VIDRO



OPL

CÓD. DESCRIÇÃO
5101 LUMINARIA TARTARUGA PRETA PVC SOFT E27
5102 LUMINARIA TARTARUGA BRANCA PVC SOFT E27
6651 LUMINARIA TARTARUGA MARROM PVC SOFT E27



ILUMI

CÓD. DESCRIÇÃO
3049 LUMINARIA TARTARUGA BRANCA 23W/25W 250V



BELLA VIDROS

CÓD. DESCRIÇÃO
2814 SPOT BRANCO
28132811 SPOT PRETO
2811 SPOT BRANCO/PRETO



BELLA VIDROS

CÓD. DESCRIÇÃO
2815 SPOT BRANCO DUPLO
28122810 SPOT PRETO DUPLO
2810 SPOT BRANCO/PRETO DUPLO



OPL

CÓD. DESCRIÇÃO
6652 SPOT TRILHO 3 X E27 BRANCO
6653 SPOT TRILHO 3 X E27 PRETO



prismaSec

CÓD. DESCRIÇÃO
3522 PLAFON BOCAL PORCELANA BRANCO 100W/250V



ULTRA

CÓD. DESCRIÇÃO
7490 PLAFON BOCAL PORCELANA BRANCO 100W/250V



OPL

CÓD. DESCRIÇÃO
5171 PLAFON BOCAL PORCELANA BRANCO 100W/250V
5268 PLAFON BOCAL PORCELANA PRETO 100W/250V



OPL

CÓD. DESCRIÇÃO
5103 PLAFON 2 LAMP. BOCAL PORC 100W/250V BRANCO

ELÉTRICA

		
<p>CÓD. DESCRIÇÃO 6646 PLAFON OCTAGONAL 100W/250V BRANCO</p>	<p>CÓD. DESCRIÇÃO 5104 PLAFON QUAD. BOCAL PORCELANA 100W/250V</p>	<p>CÓD. DESCRIÇÃO 3002 PLAFON QUAD. BOCAL PORCELANA 100W/250V</p>
		
<p>CÓD. DESCRIÇÃO 3050 PLAFON 2 LAMPADAS 100W 250V BRANCO ILUMI</p>	<p>CÓD. DESCRIÇÃO 7251 LUMINARIA LED SLIM CALHA 40W 6500K BIVOLT</p>	<p>CÓD. DESCRIÇÃO 8323 LUMINARIA LED SLIM CALHA 40W 6500K BIVOLT 8830 LUMINÁRIA LED SLIM CALHA 32W 6500K BIVOLT</p>
		
<p>CÓD. DESCRIÇÃO 7798 LUMINÁRIA LED SLIM CALHA 36W 6500K BIVOLT</p>	<p>CÓD. DESCRIÇÃO 8651 LUMINARIA EMERGENCIA 30 LEDS BATERIA LÍCIO</p>	<p>CÓD. DESCRIÇÃO 7890 LUMINÁRIA EMERGÊNCIA 30 LEDS BATERIA LÍCIO</p>
		
<p>CÓD. DESCRIÇÃO 8124 LANTERNA LED MINI COB/XPE 3W RECARREGÁVEL</p>	<p>CÓD. DESCRIÇÃO 8418 LANTERNA LED ALUMÍNIUM 300 LUMENS RECARR.</p>	<p>CÓD. DESCRIÇÃO 8419 LANTERNA LED ABS 200 LUMENS RECARREGÁVEL</p>
		
<p>CÓD. DESCRIÇÃO 8309 LANTERNA LAMPIÃO LED RECARREGÁVEL</p>	<p>CÓD. DESCRIÇÃO 8262 LANTERNA DE CABEÇA LED 3W RECARREGÁVEL</p>	<p>CÓD. DESCRIÇÃO 8264 LANTERNA LED COM MALETA RECARREGÁVEL</p>

ELÉTRICA



MAXV

CÓD. 7720 DESCRIÇÃO FITA LED 10W/M ROLO 5M 120LED/M 6500K



HDL

CÓD. 7933 DESCRIÇÃO FECHADURA ELÉTRICA HDL 12V C90 ABRE P/DENTRO



HDL

CÓD. 3379 DESCRIÇÃO FECHADURA ELETRICA 12V C90 ABRE P/DENTRO CZ



PADO

CÓD. 8448 DESCRIÇÃO FECHADURA ELÉTRICA PADO 590 150 EP



QUALITRONIX

CÓD. 8490 DESCRIÇÃO FECHADURA ELÉTRICA QUALITRONIX



HDL

CÓD. 3378 DESCRIÇÃO PORTEIRO ELETRÔNICO CLASS F-8



QUALITRONIX

CÓD. 7643 DESCRIÇÃO CAMPAINHA SEM FIO PRETA
7644 CAMPAINHA SEM FIO BRANCA



Mec-Tronic

CÓD. 1149 DESCRIÇÃO CAMPAINHA MILL 127/220V



VENTI-DELTA

CÓD. 7673 DESCRIÇÃO VENTILADOR TETO NEW VENTURA 3P 127V PRETO
7674 VENTILADOR TETO NEW VENTURA 3P 127V BRANCO



VENTI-DELTA

CÓD. 7672 DESCRIÇÃO VENTILADOR OSCILANTE COLUNA 60CM BIV PRETO



VENTI-DELTA

CÓD. 7671 DESCRIÇÃO VENTILADOR OSCILANTE PAREDE 60CM BIV PRETO



QUALITRONIX

CÓD. 7647 DESCRIÇÃO CONTROLE PARA VENTILADOR+LAMPADA SOB. BI



QUALITRONIX

CÓD. 7648 DESCRIÇÃO CONTROLE PARA VENTILADOR+LÂMPADA BIVOLT



QUALITRONIX

CÓD. 7646 DESCRIÇÃO CONTROLE PARA VENTILADOR SOBREPOR BIVOLT



MG MARGIRIUS

CÓD. 2972 DESCRIÇÃO CONTROLE P/ VENTILADOR 110V CONTROL 1
2973 CONTROLE P/ VENTILADOR 220V CONTROL 1

ELÉTRICA



CÓD.	DESCRIÇÃO
4299	FITA ISOLANTE 05M ANTI-CHAMA 3M IMPERIAL
43004301	FITA ISOLANTE 10M ANTI-CHAMA 3M IMPERIAL
4301	FITA ISOLANTE 20M ANTI-CHAMA 3M IMPERIAL



CÓD.	DESCRIÇÃO
7871	FITA ISOLANTE 5M ANTI-CHAMA
7872	FITA ISOLANTE 10M ANTI-CHAMA
7870	FITA ISOLANTE 10M ANTI-CHAMA



CÓD.	DESCRIÇÃO
2993	FITA ISOLANTE 5M ANTI-CHAMA
29942995	FITA ISOLANTE 10M ANTI-CHAMA
2995	FITA ISOLANTE 20M ANTI-CHAMA



CÓD.	DESCRIÇÃO
6540	FITA ISOLANTE 05M ANTI-CHAMA
65416542	FITA ISOLANTE 10M ANTI-CHAMA
6542	FITA ISOLANTE 20M ANTI-CHAMA



CÓD.	DESCRIÇÃO
755	FITA ISOLANTE 05M ANTI-CHAMA
756757	FITA ISOLANTE 10M ANTI-CHAMA
757	FITA ISOLANTE 20M ANTI-CHAMA



CÓD.	DESCRIÇÃO
4456	FITA ISOLANTE 5M PROFESSIONAL 3M SCOTCH



CÓD.	DESCRIÇÃO
4510	FITA ISOLANTE 10M ANTI-CHAMA
43544511	FITA ISOLANTE 20M ANTI-CHAMA
4511	FITA ISOLANTE 05M ANTI-CHAMA



CÓD.	DESCRIÇÃO
3466	FITA ISOLANTE 10M ANTI-CHAMA POTE 35



CÓD.	DESCRIÇÃO
8635	FITA ISOLANTE 20M ANTI-CHAMA 3M F. PACK
8634	FITA ISOLANTE 10M ANTI-CHAMA 3M F. PACK
8633	FITA ISOLANTE 05M ANTI-CHAMA 3M F. PACK



CÓD.	DESCRIÇÃO
8630	FITA ISOLANTE 05M ANTICHAMA (PCT10)
8631	FITA ISOLANTE 10M ANTICHAMA (PCT10)
8632	FITA ISOLANTE 20M ANTICHAMA (PCT10)



CÓD.	DESCRIÇÃO
8629	FITA ISOLANTE 20M PROFESSIONAL 930 PRO+



CÓD.	DESCRIÇÃO
8774	FITA ISOLANTE 20M PRETA
8773	FITA ISOLANTE 10M PRETA
8772	FITA ISOLANTE 05M PRETA



CÓD.	DESCRIÇÃO
4399	FITA AUTO FUSAO 19MMX2M 3M
4400	FITA AUTO FUSAO 19MMX5M 3M



CÓD.	DESCRIÇÃO
8867	KIT ESTILETE-CHAVE TESTE-FITAISOLANTE



HIDRÁULICA

HIDRÁULICA



FORTLEV

CÓD.	DESCRIÇÃO
973	TE 90 SOLD 20MM
974	TE 90 SOLD 25MM 975
975	TE 90 SOLD 32MM 2769
2769	TE 90 SOLD 40MM 976
976	TE 90 SOLD 50MM 916
916	TE 90 SOLD 60MM



FORTLEV

CÓD.	DESCRIÇÃO
973	TE 90 SOLD 32MM
974	TE 90 SOLD 40MM
975	TE 90 SOLD 50MM TE SOLD / ROSCA 20X1/2
976	TE 90 SOLD 60MM TE SOLD / ROSCA 25X1/2
919	TE SOLD / ROSCA 25X3/4



FORTLEV

CÓD.	DESCRIÇÃO
920	TE 90 REDUCAO SOLD 25X20MM
853	TE 90 REDUCAO SOLD 32X25MM
2770	TE 90 REDUCAO SOLD 40X25MM
854	TE 90 REDUCAO SOLD 50X25MM



FORTLEV

CÓD.	DESCRIÇÃO
969	JOELHO 90 SOLD 20MM
970	JOELHO 90 SOLD 25MM 971
971	JOELHO 90 SOLD 32MM 2766
2766	JOELHO 90 SOLD 40MM 972
972	JOELHO 90 SOLD 50MM 899
899	JOELHO 90 SOLD 60MM



FORTLEV

CÓD.	DESCRIÇÃO
973	JOELHO 90 SOLD 32MM
897	JOELHO 45 SOLD 20MM
898	JOELHO 45 SOLD 25MM 2765
2765	JOELHO 45 SOLD 40MM 897
897	JOELHO 90 SOLD 50MM
898	JOELHO 45 SOLD 50MM 898
898	JOELHO 45 SOLD 60MM



FORTLEV

CÓD.	DESCRIÇÃO
973	JOELHO 45 SOLD 40MM
974	JOELHO 45 SOLD 50MM
975	JOELHO 90 SOLD / ROSCA 20X1/2
976	JOELHO 45 SOLD 60MM
903	JOELHO 90 SOLD / ROSCA 25X1/2
	JOELHO 90 SOLD / ROSCA 25X3/4



FORTLEV

CÓD.	DESCRIÇÃO
900	JOELHO 90 REDUCAO SOLD 25X20MM



FORTLEV

CÓD.	DESCRIÇÃO
847	CURVA 90 SOLD 20MM
848	CURVA 90 SOLD 25MM
849	CURVA 90 SOLD 32MM
850	CURVA 90 SOLD 40MM
851	CURVA 90 SOLD 50MM
	CURVA 90 SOLD 60MM



FORTLEV

CÓD.	DESCRIÇÃO
832	BUCHA DE REDUCAO SOLD CURTA 25X20MM
833	BUCHA DE REDUCAO SOLD CURTA 32X25MM
2763	BUCHA DE REDUCAO SOLD LONGA 40X25MM
835	BUCHA DE REDUCAO SOLD LONGA 50X25MM
3067	BUCHA DE REDUCAO SOLD CURTA 50X40MM
836	BUCHA DE REDUCAO SOLD LONGA 50X32MM
834	BUCHA DE REDUCAO SOLD CURTA 60X50MM



FORTLEV

CÓD.	DESCRIÇÃO
905	LUVA SOLD / ROSCA 20X1/2
906	LUVA SOLD / ROSCA 25X1/2
3068	LUVA SOLD / ROSCA 32X1



FORTLEV

CÓD.	DESCRIÇÃO
964	LUVA SOLD 20MM
965	LUVA SOLD 25MM
966	LUVA SOLD 32MM
2767	LUVA SOLD 40MM
967	LUVA SOLD 50MM
904	LUVA SOLD 60MM



FORTLEV

CÓD.	DESCRIÇÃO
910	LUVA CORRER P/ TUBO SOLD 20MM
911	LUVA CORRER P/ TUBO SOLD 25MM
912	LUVA CORRER P/ TUBO SOLD 32MM
2768	LUVA CORRER P/ TUBO SOLD 40MM
913	LUVA CORRER P/ TUBO SOLD 50MM



FORTLEV

CÓD.	DESCRIÇÃO
908	LUVA REDUCAO SOLD 25X20MM
909	LUVA REDUCAO SOLD 32X25MM



FORTLEV

CÓD.	DESCRIÇÃO
721	TUBO SOLD 20MM FORTLEV
722	TUBO SOLD 25MM FORTLEV
724	TUBO SOLD 50MM FORTLEV



FORTLEV

CÓD.	DESCRIÇÃO
842	CAP SOLDAVEL 20MM
843	CAP SOLDAVEL 25MM
844	CAP SOLDAVEL 32MM
2764	CAP SOLDAVEL 40MM
845	CAP SOLDAVEL 50MM
846	CAP SOLDAVEL 60MM

HIDRÁULICA



CÓD.	DESCRIÇÃO
3798	REGISTRO ESFERA SOLDÁVEL 20MM
3799	REGISTRO ESFERA SOLDÁVEL 25MM
3800	REGISTRO ESFERA SOLDÁVEL 32MM
4575	REGISTRO ESFERA SOLDÁVEL 40MM



FORTLEV

CÓD.	DESCRIÇÃO
855	REGISTRO DE ESFERA SOL. C/ UNIÃO 20 MM
856857	REGISTRO DE ESFERA SOL. C/ UNIÃO 25 MM
857858	REGISTRO DE ESFERA SOL. C/ UNIÃO 32 MM
858152	REGISTRO DE ESFERA SOL. C/ UNIÃO 50 MM
1520	REGISTRO DE ESFERA SOL. C/ UNIÃO 60 MM



CÓD.	DESCRIÇÃO
4576	REGISTRO ESFERA SOLD. 50MM



FORTLEV

CÓD.	DESCRIÇÃO
837	UNIÃO SOLDÁVEL 20MM - FORTLEV
838839	UNIÃO SOLDÁVEL 25MM - FORTLEV
8392771	UNIÃO SOLDÁVEL 32MM - FORTLEV
2771840	UNIÃO SOLDÁVEL 40MM - FORTLEV
840841	UNIÃO SOLDÁVEL 50MM - FORTLEV
841	UNIÃO SOLDÁVEL 60MM - FORTLEV



FORTLEV

CÓD.	DESCRIÇÃO
828	ADAPTADOR SOLDAVEL CURTO 20X1/2
829	ADAPTADOR SOLDAVEL CURTO 25X3/4
830	ADAPTADOR SOLDAVEL CURTO 32X1
3400	ADAPTADOR SOLDAVEL CURTO 40X1.1/4
831	ADAPTADOR SOLDAVEL CURTO 50X1.1/2
1519	ADAPTADOR SOLDAVEL CURTO 60X2



FORTLEV

CÓD.	DESCRIÇÃO
823	ADAPTADOR CAIXA AGUA 20 X 1/2
824	ADAPTADOR CAIXA AGUA 25 X 3/4
825	ADAPTADOR CAIXA AGUA 32 X 1
826	ADAPTADOR CAIXA AGUA 50 X 1.1/2
827	ADAPTADOR CAIXA AGUA 60 X 2



CÓD.	DESCRIÇÃO
7665	ADAPTADOR CAIXA AGUA 20 X 1/2
7666	ADAPTADOR CAIXA AGUA 25 X 3/4
7667	ADAPTADOR CAIXA AGUA 32 X 1
7668	ADAPTADOR CAIXA AGUA 50 X 1.1/2



FORTLEV

CÓD.	DESCRIÇÃO
852	CURVA 45 SOLDÁVEL 20MM
890	CURVA 45 SOLDÁVEL 32MM
1983	CURVA 45 SOLDÁVEL 60MM
5958	CURVA 45 SOLDÁVEL 40MM



FORTLEV

CÓD.	DESCRIÇÃO
892	CURVA TRANSPOSICAO SOLDAVEL 20MM
893	CURVA TRANSPOSICAO SOLDAVEL 25MM
894	CURVA TRANSPOSICAO SOLDAVEL 32MM



FORTLEV

CÓD.	DESCRIÇÃO
908	LUVA REDUCAO SOLD 25X20MM
909	LUVA REDUCAO SOLD 32X25MM



FORTLEV

CÓD.	DESCRIÇÃO
980	JOELHO 90 ESG 40MM
981	JOELHO 90 ESG 50MM
982	JOELHO 90 ESG 75MM
983	JOELHO 90 ESG 100MM
922	JOELHO 90 ESG 150MM
3072	JOELHO 90 ESG 200MM



FORTLEV

CÓD.	DESCRIÇÃO
923	JOELHO 90 ESG COM ANEL 40MM



FORTLEV

CÓD.	DESCRIÇÃO
888	JOELHO 45 ESG 40MM
921	JOELHO 45 ESG 150MM
977	JOELHO 45 ESG 50MM
978	JOELHO 45 ESG 75MM
979	JOELHO 45 ESG 100MM
3071	JOELHO 45 ESG 200MM



FORTLEV

CÓD.	DESCRIÇÃO
924	JOELHO 90 C/ VISITA ESGOTO 100X50MM



FORTLEV

CÓD.	DESCRIÇÃO
876	CURVA 90 CURTA ESGOTO 75MM
877	CURVA 90 CURTA ESGOTO 100MM

HIDRÁULICA



FORTLEV

CÓD.	DESCRIÇÃO
874	CURVA 90 CURTA ESGOTO 40MM
875	CURVA 90 CURTA ESGOTO 50MM



FORTLEV

CÓD.	DESCRIÇÃO
883	CURVA 90 LONGA ESGOTO 40MM
885	CURVA 90 LONGA ESGOTO 75MM
886	CURVA 90 LONGA ESGOTO 100MM
887	CURVA 90 LONGA ESGOTO 150MM
3070	CURVA 90 LONGA ESGOTO 200MM



FORTLEV

CÓD.	DESCRIÇÃO
878	CURVA 45 LONGA ESGOTO 40MM
880	CURVA 45 LONGA ESGOTO 75MM
881	CURVA 45 LONGA ESGOTO 100MM
882	CURVA 45 LONGA ESGOTO 150MM



shiva

CÓD.	DESCRIÇÃO
7855	CURVA 45 ESGOTO LONGA 150 MM
7856	CURVA 45 ESGOTO LONGA 200 MM



FORTLEV

CÓD.	DESCRIÇÃO
930	LUVA ESG 40MM
987	LUVA ESG 50MM
988	LUVA ESG 75MM
989	LUVA ESG 100MM
3073	LUVA ESG 200MM



FORTLEV

CÓD.	DESCRIÇÃO
932	LUVA CORRER P/ TUBO ESG 40
934	LUVA CORRER P/ TUBO ESG 50
936	LUVA CORRER P/ TUBO ESG 75
938	LUVA CORRER P/ TUBO ESG 100



shiva

CÓD.	DESCRIÇÃO
7860	LUVA DE CORRER ESGOTO 150 MM
7861	LUVA DE CORRER ESGOTO 200 MM



FORTLEV

CÓD.	DESCRIÇÃO
925	JUNCAO 45 ESG 40MM
926	JUNCAO 45 ESG 150MM



shiva

CÓD.	DESCRIÇÃO
7859	JUNÇÃO 45 ESGOTO 200 MM



FORTLEV

CÓD.	DESCRIÇÃO
927	JUNCAO REDUCAO 45 ESG 75X50MM
929	JUNCAO REDUCAO 45 ESG 100X75MM



FORTLEV

CÓD.	DESCRIÇÃO
939	TE 90 ESG 40MM
990	TE 90 ESG 50MM
940	TE 90 ESG 75MM
991	TE 90 ESG 100MM
941	TE 90 ESG 150MM
3075	TE 90 ESG 200MM



shiva

CÓD.	DESCRIÇÃO
7862	TE 90 REDUÇÃO ESGOTO 200X150 MM



FORTLEV

CÓD.	DESCRIÇÃO
942	TE 90 REDUCAO ESG 75X50MM
943	TE 90 REDUCAO ESG 100X50MM
944	TE 90 REDUCAO ESG 100X75MM
2594	TE 90 REDUCAO ESG 150X100 MM



FORTLEV

CÓD.	DESCRIÇÃO
2179	NIPEL ROSCAVEL 1/2
2180	NIPEL ROSCAVEL 3/4



FORTLEV

CÓD.	DESCRIÇÃO
914	PLUG ROSCAVEL 1/2
915	PLUG ROSCAVEL 3/4

HIDRÁULICA



FORTLEV

CÓD.	DESCRIÇÃO
726	TUBO ESG 40MM FORTLEV
727	TUBO ESG 50MM FORTLEV
728	TUBO ESG 75MM FORTLEV
729	TUBO ESG 100MM FORTLEV
730	TUBO ESG 150MM FORTLEV



FORTLEV

CÓD.	DESCRIÇÃO
868	BUCHA DE REDUCAO LONGA ESG 50X40MM



FORTLEV

CÓD.	DESCRIÇÃO
869	CAP ESGOTO 40MM
870	CAP ESGOTO 50MM
871	CAP ESGOTO 75MM
872	CAP ESGOTO 100MM
873	CAP ESGOTO 150MM



FORTLEV

CÓD.	DESCRIÇÃO
2184	PROLONGADOR CAIXA SIF 100 x 200 MM
2185	PROLONGADOR CAIXA SIF 150 x 200 MM



FORTLEV

CÓD.	DESCRIÇÃO
933	REDUCAO EXCENTRICA ESG 75X50MM
935	REDUCAO EXCENTRICA ESG 100X50MM
937	REDUCAO EXCENTRICA ESG 100X75MM
1981	REDUCAO EXCENTRICA ESG 150X100MM
3074	REDUCAO EXCENTRICA ESG 200X150



VALEPLAST

CÓD.	DESCRIÇÃO
7867	VÁLVULA DE RETENÇÃO BR ESGOTO 70MM
7868	VÁLVULA DE RETENÇÃO BR ESGOTO 100MM



FORTLEV

CÓD.	DESCRIÇÃO
741	CAIXA DE POLIETILENO 100 LT C/ TAMPA
742743	CAIXA DE POLIETILENO 150 LT C/ TAMPA
743807	CAIXA DE POLIETILENO 250 LT C/ TAMPA
807808	CAIXA DE POLIETILENO 310 LT C/ TAMPA
808809	CAIXA DE POLIETILENO 500 LT C/ TAMPA
809	CAIXA DE POLIETILENO 1.000 LT C/ TAMPA



BAKOFTEC

CÓD.	DESCRIÇÃO
8579	CAIXA DE POLIETILENO 250 LT COM TAMPA
8580	CAIXA DE POLIETILENO 310 LT COM TAMPA
8581	CAIXA DE POLIETILENO 500 LT COM TAMPA
8582	CAIXA DE POLIETILENO 1.000 LT COM TAMPA



deca

CÓD.	DESCRIÇÃO
2049	TOR. BÓIA 1/2 BRONZE/LATÃO 4416/102
2050	TOR. BÓIA 3/4 BRONZE/LATÃO 1350 BSA.012



docol

CÓD.	DESCRIÇÃO
4851	TORNEIRA BOIA 1/2 BRONZE LATÃO
4859	TORNEIRA BOIA 3/4 BRONZE LATÃO



deca

CÓD.	DESCRIÇÃO
7710	TORNEIRA BOIA 1 BRONZE/LATÃO



VALEPLAST

CÓD.	DESCRIÇÃO
7389	TORNEIRA BOIA BEBEDOURO 1/2 E 3/4 HASTE ALUMINIO



Blukit

CÓD.	DESCRIÇÃO
3720	TORNEIRA BOIA C/FLANGE VAZAO TOTAL 1/2 X 3/4



FORTLEV

CÓD.	DESCRIÇÃO
1869	TOR. BÓIA HASTE ALUMÍNIO 1/2 OU 3/4



Garden
qualidade e resistência

CÓD.	DESCRIÇÃO
7484	TORNEIRA BOIA 1/2 E 3/4 VERDE GARDEN

HIDRÁULICA



Garden
qualidade e resistência

CÓD. DESCRIÇÃO
2777 TORNEIRA BOIA ZAMAC 1/2 BALAO REFORÇADO
4930 TORNEIRA BOIA VAZÃO TORAL 1/2



Garden
qualidade e resistência

CÓD. DESCRIÇÃO
8945 TORNEIRA BOIA VAZÃO TOTAL 3/4



Garden
qualidade e resistência

CÓD. DESCRIÇÃO
8946 TORNEIRA BOIA 1/2 COM BALÃO LATÃO

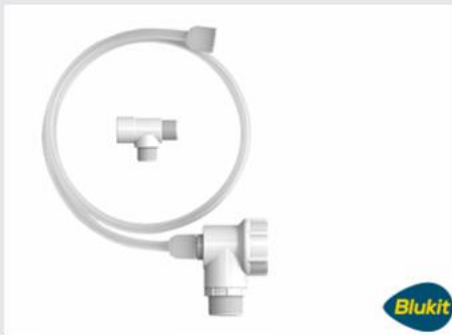

Blukit

CÓD. DESCRIÇÃO
2835 VÁLV. ALTER. DE PRESSÃO P/CX D'AGUA



Blukit

CÓD. DESCRIÇÃO
4881 VALVULA REDUTORA DE PRESSAO 3/4



Blukit

CÓD. DESCRIÇÃO
7829 KIT VÁLVULA REDUTORA DE PRESSÃO COM DUCHÃO



VALEPLAST

CÓD. DESCRIÇÃO
7543 MECANISMO COMPLETO UNIV.P/CX ACOPLADA



ASTRA

CÓD. DESCRIÇÃO
6678 MECANISMO COMPLETO UNIV.P/CX. ACOPL.



Blukit

CÓD. DESCRIÇÃO
1199 MECANISMO ENTR. UNIV. P/CX ACOPL.



ASTRA

CÓD. DESCRIÇÃO
6675 MECANISMO ENTR. UNIV. P/CX. ACOPL.



Blukit

CÓD. DESCRIÇÃO
1200 MECANISMO COMPLETO UNIV. P/CX . ACOPL.



Blukit

CÓD. DESCRIÇÃO
3795 MECANISMO COMPLETO DUPLO COMANDO P/CX AC.



Blukit

CÓD. DESCRIÇÃO
3796 MECANISMO SAIDA DUPLO COMANDO P/CX. ACOPL



Blukit

CÓD. DESCRIÇÃO
1193 MECANISMO SAÍDA UNIV. P/CX ACOPL.



ASTRA

CÓD. DESCRIÇÃO
6667 MECANISMO SAIDA UNIV. P/CX. ACOPLADA

HIDRÁULICA



ASTRA

CÓD. DESCRIÇÃO
6995 CORRENTE CADEADA C/FIXADOR PARA CX ACOPLADA



Blukit

CÓD. DESCRIÇÃO
3725 OBTURADOR UNIVERSAL P/ MEC SAIDA P/ CX ACOPL



ASTRA

CÓD. DESCRIÇÃO
6676 OBTURADOR UNIVERSAL P/MEC SAIDA P/CX ACOPL.



ASTRA

CÓD. DESCRIÇÃO
7244 CAIXA DESCARGA CARAMELO 9L CONTROLADA



metasul

CÓD. DESCRIÇÃO
1299 CAIXA DESCARGA BEGE
13001301CAIXA DESCARGA BRANCA
13015871CAIXA DESCARGA CINZA CLARO
5871 CAIXA DESCARGA METASUL CARAMELO



ASTRA

CÓD. DESCRIÇÃO
4538 CAIXA DESCARGA BEGE 9L CONTROLADA
45394540CAIXA DESCARGA CINZA 9L CONTROLADA
4540 CAIXA DESCARGA BRANCA 9L CONTROLADA



deca

CÓD. DESCRIÇÃO
7513 CAIXA ACOPLADA CERÂMICA PARA VASO SANITÁRIO



deca

CÓD. DESCRIÇÃO
7515 BACIA SANITÁRIA PARA CAIXA ACOPLADA CERÂMICA



deca

CÓD. DESCRIÇÃO
7514 BACIA SANITÁRIA CONVENCIONAL CERÂMICA



Roca

CÓD. DESCRIÇÃO
8840 CAIXA ACOPLADA CERÂMICA P/ VASO SAN. PARATI



Roca

CÓD. DESCRIÇÃO
8839 BACIA SANITÁRIA PARA CAIXA ACOPL. CER. PARATI



Roca

CÓD. DESCRIÇÃO
8926 BACIA SANITÁRIA CONVENCIONAL CERÂMICA PARATI



ASTRA

CÓD. DESCRIÇÃO
6996 CABEÇOTE TORRE ENTRADA PARA CAIXA ACOPLADA



ASTRA

CÓD. DESCRIÇÃO
6677 BOTAO ACION.SUP.UNIV.ABS BRANCO P/CX.ACOPL



Blukit

CÓD. DESCRIÇÃO
1194 BOTÃO A. SUP. UNIV. ABS BRANCO P/CX ACOPL.
3722 REPARO ACIONADOR MECANISMO ASTRA

HIDRÁULICA



CÓD.	DESCRIÇÃO
2952	PF FIXACAO VASO SANITARIO B10
2953	PF FIXACAO VASO SANITARIO B12



CÓD.	DESCRIÇÃO
1448	TUBO DESCIDA 1,20M CAIXA DESCARGA METASUL
1449	TUBO DESCIDA 1,60M CAIXA DESCARGA METASUL



CÓD.	DESCRIÇÃO
6997	BOLSA DE VEDACAO UNIVERSAL P/ CAIXA ACOPLADA



CÓD.	DESCRIÇÃO
3723	VEDACAO UNIVERSAL SAIDA P/ CAIXA ACOPLADA



CÓD.	DESCRIÇÃO
1440	ANEL DE VEDACAO VASO SAN. C/GUIA



CÓD.	DESCRIÇÃO
5520	ANEL DE VEDACAO VASO SAN. C/ GUIA



CÓD.	DESCRIÇÃO
5111	ANEL DE VEDAÇÃO VASO SANITÁRIO COM GUIA



CÓD.	DESCRIÇÃO
4572	ANEL DE VEDAÇÃO VASO SAN. C/ GUIA PULVITEC



CÓD.	DESCRIÇÃO
6364	ANEL DE VEDACAO VASO SAN. C/GUIA VEDAH



CÓD.	DESCRIÇÃO
5533	ANEL DE VEDACAO VASO SAN. S/ GUIA



CÓD.	DESCRIÇÃO
1028	SPUD SANFONADO VALEPLAST



CÓD.	DESCRIÇÃO
6994	SPUD SANFONADO ASTRA



CÓD.	DESCRIÇÃO
1191	TUBO DE LIG INTELIGENTE BRANCO



CÓD.	DESCRIÇÃO
1192	TUBO DE LIG INTELIGENTE METALIZADO



CÓD.	DESCRIÇÃO
1719	TUBO DE LIGAÇÃO SANF. METALIZADO

HIDRÁULICA



ASTRA

CÓD. DESCRIÇÃO
6671 TUBO DE LIGAÇÃO SANF. BRANCO



ASTRA

CÓD. DESCRIÇÃO
6672 TUBO DE LIGAÇÃO SANF. METALIZADO



VALEPLAST

CÓD. DESCRIÇÃO
1718 TUBO DE LIGAÇÃO SANF. BRANCO 25 CM



ASTRA

CÓD. DESCRIÇÃO
6673 TUBO DE LIGAÇÃO SANF. PRETO



REBOUCAS

DESCRIÇÃO
8968 CANO PARA CHUVEIRO 30 CM ABS BRANCO



ALUREM

DESCRIÇÃO
2645 CANO P/ CHUVEIRO 30 CM POLIDO
2646 CANO P/ CHUVEIRO 40 CM POLIDO

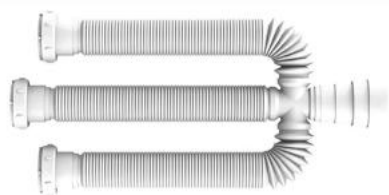

VALEPLAST

CÓD. DESCRIÇÃO
3464 SIFAO TRIPLO BRANCO



ASTRA

CÓD. DESCRIÇÃO
6999 SIFÃO UNIVERSAL BRANCO



Blukit

CÓD. DESCRIÇÃO
1189 SIFÃO UNIVERSAL BRANCO
3716 SIFÃO UNIVERSAL BRANCO 1,5M



docol

CÓD. DESCRIÇÃO
4845 SIFÃO UNIVERSAL BRANCO EXTENSÍVEL 72CM



VALEPLAST

CÓD. DESCRIÇÃO
739 SIFÃO DUPLO BRANCO

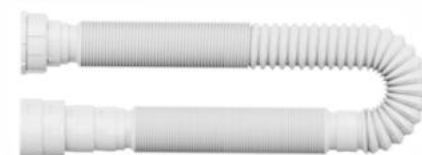

UNIFORTE

CÓD. DESCRIÇÃO
7990 SIFÃO UNIVERSAL CROMADO



Blukit

CÓD. DESCRIÇÃO
1190 SIFÃO DUPLO BRANCO



VALEPLAST

CÓD. DESCRIÇÃO
738 SIFÃO UNIVERSAL BRANCO



Blukit

CÓD. DESCRIÇÃO
6499 SIFAO DUPLO PRETO

HIDRÁULICA



Blukit

CÓD.	DESCRIÇÃO
6497	SIFAO UNIVERSAL PRETO
6498	SIFAO UNIVERSAL PRETO 1,1M



ASTRA

CÓD.	DESCRIÇÃO
6406	SIFAO UNIVERSAL PRETO



Blukit

CÓD.	DESCRIÇÃO
1970	SIFÃO UNIVERSAL CROMADO



UNIFORTE

CÓD.	DESCRIÇÃO
7991	SIFÃO UNIVERSAL CROMADO



VALEPLAST

CÓD.	DESCRIÇÃO
740	SIFÃO METALIZADO UNIVERSAL



ASTRA

CÓD.	DESCRIÇÃO
6998	SIFÃO UNIVERSAL CROMADO



VALEPLAST

CÓD.	DESCRIÇÃO
3998	SIFAO DUPLO CROMADO VALEPLAST

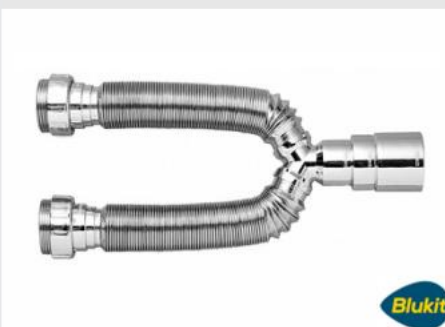

Blukit

CÓD.	DESCRIÇÃO
3719	SIFÃO DUPLO CROMADO



Blukit

CÓD.	DESCRIÇÃO
3718	SIFAO COPO UNIVERSAL BRANCO



ASTRA

CÓD.	DESCRIÇÃO
5265	ASSENTO TALENTO BEGE OVAL EM PP
5266	ASSENTO TALENTO BRANCO OVAL EM PP
5267	ASSENTO TALENTO CINZA OVAL EM PP



metasul

CÓD.	DESCRIÇÃO
1378	ASSENTO LOFT BEGE
13791380	ASSENTO LOFT BRANCO
13801381	ASSENTO LOFT CARAMELO
13814059	ASSENTO LOFT CINZA CLARO
4059	ASSENTO LOFT CINZA ESCURO



ATLAS

CÓD.	DESCRIÇÃO
6397	ASSENTO ALMOFODADO CINZA QUADRADO
63986398	ASSENTO ALMOFODADO BEGE QUADRADO
6399	ASSENTO ALMOFODADO BRANCO QUADRADO



metasul

CÓD.	DESCRIÇÃO
4753	ASSENTO COMFORT MULTI METASUL BRANCO



ASTRA

CÓD.	DESCRIÇÃO
4547	ASSENTO ALMOFADADO BEGE ASTRA
45484548	ASSENTO ALMOFADADO BRANCO ASTRA
4549	ASSENTO ALMOFADADO CINZA ASTRA



ATLAS

CÓD.	DESCRIÇÃO
6896	ASSENTO ALMOFADADO BASICO BRANCO ATLAS

HIDRÁULICA



ASTRA

CÓD. DESCRIÇÃO
7351 ASSENTO ALMOFADADO SLIM BRANCO ASTRA



ASTRA

CÓD. DESCRIÇÃO
7062 ASSENTO MISTO BRANCO ASTRA



metasul

CÓD. DESCRIÇÃO
1384 ASSENTO PER. MULTI QUAD. BISCUIT
13151316 ASSENTO PER. MULTI QUAD. BRANCO
13161383 ASSENTO PER. MULTI QUAD. CINZA CL.
1383 ASSENTO PER. MULTI QUAD. PRETO



metasul

CÓD. DESCRIÇÃO
1317 ASSENTO PLUS BEGE ALMOFA.
12981318 ASSENTO PLUS BRANCO ALMOFA.
13181382 ASSENTO PLUS CINZA CLARO ALMOFA.
1382 ASSENTO PLUS CINZA ESCURO ALMOFA.



ASTRA

CÓD. DESCRIÇÃO
4544 ASSENTO POPULAR BEGE ASTRA
45454546 ASSENTO POPULAR BRANCO ASTRA
4546 ASSENTO POPULAR CINZA ASTRA



ATLAS

CÓD. DESCRIÇÃO
5360 ASSENTO ALMOFADADO CLASSICO CINZA
5645 ASSENTO ALMOFADADO CLASSICO BEGE
5881 ASSENTO ALMOFADADO CLASSICO CARAMELO
5374 ASSENTO ALMOFADADO CLASSICO BRANCO
6162 ASSENTO ALMOFADADO CLASSICO PRETO



TUPY

CÓD. DESCRIÇÃO
6140 LUVA GALVANIZADO 1/2 TUPY
61416142 LUVA GALVANIZADO 3/4 TUPY
61426143 LUVA GALVANIZADO 1 TUPY
61436144 LUVA GALVANIZADO 3/8 TUPY
6144 LUVA GALVANIZADO 1.1/4 TUPY



TUPY

CÓD. DESCRIÇÃO
6127 CURVA GALVANIZADO 2.1/2 TUPY
61286129 CURVA GALVANIZADO 3/4 TUPY
6129 CURVA GALVANIZADO 1/2 TUPY



TUPY

CÓD. DESCRIÇÃO
6104 BUJAO GALVANIZADO 1/4 TUPY
61056106 BUJAO GALVANIZADO 1/2 TUPY
61066107 BUJAO GALVANIZADO 3/4 TUPY
61076108 BUJAO GALVANIZADO 1 TUPY
6108 BUJAO GALVANIZADO 1.1/2 TUPY



TUPY

CÓD. DESCRIÇÃO
6109 COTOVELO 45 GALVANIZADO 3/4 TUPY
6110 COTOVELO 45 GALVANIZADO 1 TUPY



TUPY

CÓD. DESCRIÇÃO
6111 COTOVELO 45 GALVANIZADO 1.1/2 TUPY
61126113 COTOVELO 45 GALVANIZADO 1.1/4 TUPY
6113 COTOVELO 45 GALVANIZADO 3/8 TUPY



TUPY

CÓD. DESCRIÇÃO
6130 CURVA GALVANIZADO 1 TUPY
61316132 CURVA GALVANIZADO 1.1/4 TUPY
6132 CURVA GALVANIZADO 1.1/2 TUPY



TUPY

CÓD. DESCRIÇÃO
6133 CURVA MACHO GALVANIZADO 1 TUPY
6134 CURVA MACHO GALVANIZADO 1.1/2 TUPY



TUPY

CÓD. DESCRIÇÃO
6135 CURVA MACHO E FEMEA GALVANIZADO 3/8 TUPY
61366137 CURVA MACHO E FEMEA GALVANIZADO 1/2 TUPY
61376138 CURVA MACHO E FEMEA GALVANIZADO 3/4 TUPY
6138 CURVA MACHO E FEMEA GALVANIZADO 1.1/2 TUPY



TUPY

CÓD. DESCRIÇÃO
6139 ADAPTADOR CAIXA AGUA GALVANIZADO 20X1/2

HIDRÁULICA



CÓD.	DESCRIÇÃO
6124	CURVA DE RETORNO GALVANIZADO 1/2 TUPY
6125	CURVA DE RETORNO GALVANIZADO 1 TUPY
6126	CURVA DE RETORNO GALVANIZADO 1.1/2 TUPY



CÓD.	DESCRIÇÃO
6149	LUVA DE REDUCAO GALVANIZADO 3/4 X 1/2 TUPY
6150	LUVA DE REDUCAO GALVANIZADO 1 X 1/2 TUPY



CÓD.	DESCRIÇÃO
6151	LUVA DE REDUCAO GALVANIZADO 1 X 3/4 TUPY
6152	LUVA DE REDUCAO GALVANIZADO 3 X 1.1/2 TUPY



CÓD.	DESCRIÇÃO
945	ANEL DE VEDACAO ESGOTO 40MM
946	ANEL DE VEDACAO ESGOTO 50MM
947	ANEL DE VEDACAO ESGOTO 75MM
948	ANEL DE VEDACAO ESGOTO 100MM
949	ANEL DE VEDACAO ESGOTO 150MM
2593	ANEL DE VEDACAO ESGOTO 200MM



CÓD.	DESCRIÇÃO
6118	CRUZETA GALVANIZADO 1/2 TUPY
6119	CRUZETA GALVANIZADO 3/8 TUPY
6120	CRUZETA GALVANIZADO 1/4 TUPY
6121	CRUZETA GALVANIZADO 3/4 TUPY
6122	CRUZETA GALVANIZADO 1 TUPY
6123	CRUZETA GALVANIZADO 1.1/2 TUPY



CÓD.	DESCRIÇÃO
7495	TE GALVANIZADO 1/2
7496	TE GALVANIZADO 3/4
7497	TE GALVANIZADO 1
7498	TE GALVANIZADO 1.1/2



CÓD.	DESCRIÇÃO
6095	BUCHA DE REDUCAO 1/2 X 1/4
6096	BUCHA DE REDUCAO 3/4 X 1/2
6097	BUCHA DE REDUCAO 1 X 3/4
6098	BUCHA DE REDUCAO 1.1/2 X 1
6099	BUCHA DE REDUCAO 1.1/2 X 1.1/4
6100	BUCHA DE REDUCAO 1.1/2 X 1/2
6101	BUCHA DE REDUCAO 1.1/2 X 3/4
6102	BUCHA DE REDUCAO 1.1/4 X 1
6103	BUCHA DE REDUCAO 1.1/4 X 3/4



CÓD.	DESCRIÇÃO
8936	BUCHA DE REDUCAO METAL 3/4" X 1/2" AMARELA



CÓD.	DESCRIÇÃO
3750	MODULO DE REDUCAO ROSCA N.01
3738	MODULO DE REDUCAO ROSCA N.04
3739	MODULO DE REDUCAO ROSCA N.05
3743	MODULO DE REDUCAO ROSCA N.10
3751	MODULO DE REDUCAO ROSCA N.34
3752	MODULO DE REDUCAO ROSCA N.35
3753	MODULO DE REDUCAO ROSCA N.45
3749	MODULO DE REDUCAO ROSCA N.48



CÓD.	DESCRIÇÃO
8935	BUCHA AUMENTO METAL 1/2" X 3/4" AMARELA



CÓD.	DESCRIÇÃO
6114	COTOVELO 90 GALVANIZADO 1/2 TUPY
6115	COTOVELO 90 GALVANIZADO 3/4 TUPY
6116	COTOVELO 90 GALVANIZADO 1 TUPY
6117	COTOVELO 90 GALVANIZADO 1.1/4 TUPY



CÓD.	DESCRIÇÃO
6145	LUVA MACHO E FEMEA GALVANIZADO 1/2 TUPY
6146	LUVA MACHO E FEMEA GALVANIZADO 3/4 TUPY
6147	LUVA MACHO E FEMEA GALVANIZADO 1 TUPY
6148	LUVA MACHO E FEMEA GALVANIZADO 1.1/4 TUPY



CÓD.	DESCRIÇÃO
8942	NIPLE METAL 1/2" X 1/2" BSP



CÓD.	DESCRIÇÃO
6159	NIPLE DUPLO REDUCAO GALVANIZADO 3/4 X 3/8
6160	NIPLE DUPLO REDUCAO GALVANIZADO 3/4 X 1/2
6161	NIPLE DUPLO REDUCAO GALVANIZADO 1.1/2 X 1.1/4



CÓD.	DESCRIÇÃO
6153	NIPLE DUPLO GALVANIZADO 1/2 TUPY
6154	NIPLE DUPLO GALVANIZADO 3/4 TUPY
6155	NIPLE DUPLO GALVANIZADO 1 TUPY
6156	NIPLE DUPLO GALVANIZADO 1.1/2 TUPY
6157	NIPLE DUPLO GALVANIZADO 1.1/4 TUPY
6158	NIPLE DUPLO GALVANIZADO 2 TUPY

HIDRÁULICA



FORTLEV

CÓD. DESCRIÇÃO
2591 RALO SIF 100 X 52 X 40 MM QUAD BR



FORTLEV

CÓD. DESCRIÇÃO
2592 RALO SECO 100X52X40MM QUAD BR



RIP
REBOUCAS

CÓD. DESCRIÇÃO
1866 RALO REDONDO 10 X 10 R051N

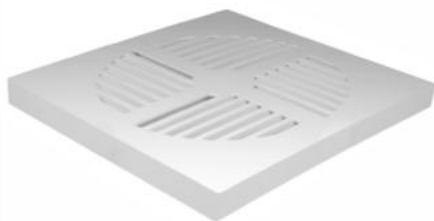

FORTLEV

CÓD. DESCRIÇÃO
2183 GRELHA 100MM QUADRADA BRANCA



FORTLEV

CÓD. DESCRIÇÃO
3260 GRELHA 150MM QUADRADA BRANCA



FORTLEV

CÓD. DESCRIÇÃO
3781 GRELHA 100MM REDONDA BRANCA



HIDRA

CÓD. DESCRIÇÃO
3117 GRELHA INOX QUADRADA 15CM C/ FECHO ACO



HIDRA

CÓD. DESCRIÇÃO
3118 GRELHA INOX REDONDA 10CM C/ FECHO ACO
3119 GRELHA INOX REDONDA 15CM C/ FECHO ACO



FORTLEV

CÓD. DESCRIÇÃO
5571 PORTA-GRELHA 150MM RED BR
5570 GRELHA 150MM RED BRANCA



FORTLEV

CÓD. DESCRIÇÃO
2181 PORTA GRELHA 100MM QUADRADO BRANCO
3780 PORTA GRELHA 100MM REDONDO BRANCO
2182 PORTA GRELHA 150MM QUADRADO BRANCO



HIDRA

CÓD. DESCRIÇÃO
4974 PORTA GRELHA INOX 100MM QUADRADO



RIP
REBOUCAS

CÓD. DESCRIÇÃO
7424 CAIXA SIFONADA 100X100X50 QUADRADA BRANCA



RIP
REBOUCAS

CÓD. DESCRIÇÃO
7425 CAIXA SIFONADA 100X100X50 QUADRADA CROMADA



ASTRA

CÓD. DESCRIÇÃO
4841 CAIXA SIFONADA 150X150X50 GRELHA ALUM. QU



FORTLEV

CÓD. DESCRIÇÃO
3964 CAIXA SIFONADA 100X150X50 BR QUAD

HIDRÁULICA



ASTRA

CÓD. DESCRIÇÃO
4840 CAIXA SIFONADA 100X100X50 GRELHA ALUM. QU



ASTRA

CÓD. DESCRIÇÃO
4541 CAIXA SIFONADA 100X100X50 BR QUADRADO



FORTLEV

CÓD. DESCRIÇÃO
1985 CAIXA SIFONADA 250 X 230 X 75 QUAD BR
1986 CAIXA SIFONADA 250 X 172 X 50 QUAD BR



FORTLEV

CÓD. DESCRIÇÃO
950 CAIXA SIFONADA 100 X 100 X 50 QUADRADA
95295 CAIXA SIFONADA 100 X 100 X 50 REDONDA
951 CAIXA SIFONADA 150 X 150 X 50 QUADRADA



FORTLEV

CÓD. DESCRIÇÃO
1987 CAIXA SIFONADA 250X172X50 RED BR



FORTLEV

CÓD. DESCRIÇÃO
7988 CORPO CAIXA SIF 100X100X50



Milton
do Brasil

CÓD. DESCRIÇÃO
1067 CAIXA DE PASSAGEM PRETA 48 LITROS



Milton
do Brasil

CÓD. DESCRIÇÃO
8546 CAIXA DE PASSAGEM PEQUENA REDONDA 10L



metasul
Soluções em Plástico

CÓD. DESCRIÇÃO
1305 CAIXA DE PASSAGEM 4,5 LITROS PRETA



Milton
do Brasil

CÓD. DESCRIÇÃO
7465 CAIXA COLETORA AGUA PLUVIAL GRANDE 48L



Milton
do Brasil

CÓD. DESCRIÇÃO
1218 PROLONGADOR CAIXA PASSAGEM
1219 PROLONGADOR CAIXA GORDURA



Milton
do Brasil

CÓD. DESCRIÇÃO
7960 PROLONGADOR CAIXA GORDURA 10 LITROS



Milton
do Brasil

CÓD. DESCRIÇÃO
7466 CAIXA AGUA PLUVIAL 10L



Milton
do Brasil

CÓD. DESCRIÇÃO
7958 TAMPA CAIXA PASSAGEM 48L



Milton
do Brasil

CÓD. DESCRIÇÃO
7959 TAMPA CAIXA DE GORDURA QUADRADA 42L

HIDRÁULICA



Milton do Brasil

CÓD. DESCRIÇÃO
7957 TAMPA CAIXA GORDURA 50L



Milton do Brasil

CÓD. DESCRIÇÃO
7592 CAIXA DE GORDURA TAMPA QUADRADA 42 LITROS



FORTLEV

CÓD. DESCRIÇÃO
6504 CAIXA DE GORDURA C/ CESTO 21L



Milton do Brasil

CÓD. DESCRIÇÃO
1066 CAIXA DE GORDURA



Milton do Brasil

CÓD. DESCRIÇÃO
3992 CAIXA SIFONADA 250X250X75/100 10 L



Milton do Brasil

CÓD. DESCRIÇÃO
3993 CALHA DE PISO 1000X150X120MM PRETA



SSLARES MG

CÓD. DESCRIÇÃO
7971 RALO LINEAR 06X50CM BRANCO SS
7972 RALO LINEAR 06X50CM CINZA SS



fabrinox

CÓD. DESCRIÇÃO
1487 PIA INOX 1,20 PREMIUM C/CUBA
14881489 PIA INOX 1,50 PREMIUM C/CUBA
1489 PIA INOX 1,80 PREMIUM C/CUBA



ASTRA

CÓD. DESCRIÇÃO
5263 LAVATORIO PLASTICO 36X28CM 3,8 L



fabrinox

CÓD. DESCRIÇÃO
1490 CUBA N01F AÇO INOX 460 X 300 X 140 PREM.
1491 CUBA N01F AÇO INOX 560 X 340 X 145 PREM.



ASTRA

CÓD. DESCRIÇÃO
5264 TANQUE PLASTICO P/LAVAR ROUPA 47X43X27 22L

HIDRÁULICA



Garden
qualidade e resistência

CÓD. DESCRIÇÃO
8943 BICO TORNEIRA 3/4" X 1/2" PLASTICO BRANCO
8944 BICO TORNEIRA 3/4" X 1/2" PLASTICO PRETO



RIP
REBOUCAS

CÓD. DESCRIÇÃO
1832 TAMPA P/ LAVATORIO E PIA TV51N
1867 TAMPA P/ TANQUE TV52N



RIP
REBOUCAS

CÓD. DESCRIÇÃO
4346 VALVULA TANQUE ABS BRANCA 1.1/2 REBOUCAS V9
5250 VALVULA TANQUE ABS CROMADA 1.1/2 V9



RIP
REBOUCAS

CÓD. DESCRIÇÃO
4345 VALVULA AMER. ABS CRO. C/ CESTINHA REBOUCAS



metasul

CÓD. DESCRIÇÃO
1450 VALVULA LAVATORIO ABS BRANCA METASUL V8
1451 VALVULA TANQUE ABS BRANCA 1.1/2 METASUL V9



RIP
REBOUCAS

CÓD. DESCRIÇÃO
4343 VALVULA LAVATORIO ABS BRANCA REBOUCAS V8
4344 VALVULA LAVATORIO ABS CROMADA REBOUCAS V8



TDG
THERMOPLÁSTICO

CÓD. DESCRIÇÃO
1031 VÁLVULA LAVATÓRIO ABS CROMADA TDG V8



RIP
REBOUCAS

CÓD. DESCRIÇÃO
1831 CESTO P/ PIA AME. CROMADO C56CN



THOMPSON

CÓD. DESCRIÇÃO
1935 RALINHO INOX CHINES 3 1/2 VÁLV AMERICANA
1934 RALINHO INOX CHINES PIA/LAV/TANQUE



INCA
METALURGICA INCA LTDA.

CÓD. DESCRIÇÃO
7883 VEDANTE AÇO COM ARRUELA DE COURO 1/2
7884 VEDANTE AÇO COM ARRUELA DE COURO 3/4



Garden
qualidade e resistência

CÓD. DESCRIÇÃO
4931 JUNÇÃO Y METAL P/ FILTRO 1/2"



Garden
qualidade e resistência

CÓD. DESCRIÇÃO
7774 ADAPTADOR T METAL TANQUE MAQUINA LAVAR 1/2



BOMVINK

CÓD. DESCRIÇÃO
8569 TORNEIRA TANQUE MÁQUINA METAL



BOMVINK

CÓD. DESCRIÇÃO
8578 TORNEIRA ESFERA JARDIM BRANCA PLÁSTICA



BOMVINK

CÓD. DESCRIÇÃO
8786 MISTURADOR MONOCOMANDO COZINHA FLEX

HIDRÁULICA



THOMPSON

CÓD. DESCRIÇÃO
3370 TORNEIRA ESFERA 1/2 CABO VERM. MAQ. LAVAR



THOMPSON

CÓD. DESCRIÇÃO
1437 TORNEIRA ESFERA CABO VERMELHO 1/2 X 3/4



THOMPSON

CÓD. DESCRIÇÃO
4067 TORNEIRA ESFERA CADEADO 1/2" X 3/4"



THOMPSON

CÓD. DESCRIÇÃO
3368 TORNEIRA ESFERA 1/2 CABO VERM. METAL
3369 TORNEIRA ESFERA 3/4 CABO VERM. METAL



MEGA IMPORTADORA

CÓD. DESCRIÇÃO
1070 TORNEIRA ESFERA CABO PRETO 1/2



MEGA IMPORTADORA

CÓD. DESCRIÇÃO
1208 TORNEIRA ESFERA 1/2 CABO PRETO MAQ. LAVAR



deca

CÓD. DESCRIÇÃO
5708 TORNEIRA HYDRAPLUS COZINHA BANCADA BRANCA



deca

CÓD. DESCRIÇÃO
5768 TORNEIRA BANHEIRO HYDRAPLUS BRANCA



VALEPLAST

CÓD. DESCRIÇÃO
1110 TORNEIRA COZ. MESA GIR. ABS BRANCA
1109111 TORNEIRA COZ. PAREDE GIR. ABS BRANCA
1111 TORNEIRA LAV. MESA GIR. ABS BRANCA



VALEPLAST

CÓD. DESCRIÇÃO
1112 TORNEIRA MAQ. LAVAR ABS BRANCA



deca

CÓD. DESCRIÇÃO
5709 TORNEIRA HYDRAPLUS 1130 BRANCA



deca















CÓD. DESCRIÇÃO
5767 TORNEIRA TANQUE E MAQUINA HYDRAPLUS BRANCA



RIP REBOUCAS

CÓD. DESCRIÇÃO
1865 TORNEIRA PIA 15CM 1/2 C/ BICO TTV18N

HIDRÁULICA

		
<p>CÓD. 1829 DESCRIÇÃO TORNEIRA P/ LAVATORIO 1/2 TTV7N</p>	<p>CÓD. 5175 1864 DESCRIÇÃO TORNEIRA PLÁSTICA BRANCA 1/2 TORNEIRA PLÁSTICA PRETA 1/2</p>	<p>CÓD. 1828 DESCRIÇÃO TORNEIRA COZI./ALAVANCA 1/2 TTV8N</p>
		
<p>CÓD. 1826 1830 DESCRIÇÃO TORNEIRA TAN./CURTA 10CM 1/2 TTV3N TORNEIRA TANQUE/CURTA 10CM C/BICO TTV16N</p>	<p>CÓD. 5743 5744 DESCRIÇÃO TORNEIRA ELETRICA EASY 4800W 127V TORNEIRA ELETRICA EASY 5500W 220V</p>	<p>CÓD. 1113 DESCRIÇÃO TORNEIRA LAV. MESA FIXA ABS BRANCA</p>
		
<p>CÓD. 5172 DESCRIÇÃO REGISTRO ESFERA MAQU. LAVAR BRANCO/PR 1/2</p>	<p>CÓD. 8340 DESCRIÇÃO MISTURADOR MONOCOMANDO B. PRETO 17CM</p>	<p>CÓD. 8482 DESCRIÇÃO MIST. MONO GOURMET C/ BICA EXT. P/ COZINHA</p>
		
<p>CÓD. 8482 DESCRIÇÃO MIST. MONO BANHEIRO PRETO 36.5 CM</p>	<p>CÓD. 8416 DESCRIÇÃO TORNEIRA LAVATÓRIO TEMPORIZADA</p>	<p>CÓD. 5782 DESCRIÇÃO ACABAMENTO P/ REGISTRO 1/2 OU 3/4 C-43</p>
		
<p>CÓD. 4341 DESCRIÇÃO ACABAMENTO P/ REGISTRO 1/2 3/4 MAX C-34</p>	<p>CÓD. 4864 4863 DESCRIÇÃO ACAB. P/ REGISTRO 1.1/2 NOVA PERTUTTI ACAB. P/ REGISTRO 1/2 3/4 PRIMOR</p>	<p>CÓD. 5605 DESCRIÇÃO ACABAMENTO P/ REGISTRO 1.1/2 ASPEN C-35</p>

HIDRÁULICA



deca

CÓD.	DESCRIÇÃO
4340	ACABAMENTO P/ REGISTRO 1/2 OU 3/4 ASPEN C-35



deca

CÓD.	DESCRIÇÃO
4342	ACABAMENTO P/ REGISTRO 1/2 3/4 C-50
7002	ACABAMENTO P/ REGISTRO 1.1/2 C-50



deca

CÓD.	DESCRIÇÃO
5745	ACABAMENTO MONOCOMANDO P/ CHUVEIRO LINK
7001	ACABAMENTO PARA REGISTRO 1/2 OU 3/4 LINK
7000	ACABAMENTO PARA REGISTRO 1.1/2 LINK



docol

CÓD.	DESCRIÇÃO
4862	ACAB. P/ REGISTRO 1.1/2 NOVA PERTUTTI
4861	ACAB. P/ REGISTRO 1/2 3/4 NOVA PERTUTTI



docol

CÓD.	DESCRIÇÃO
4867	REGISTRO PRESSAO 3/4 DOCOL C/ AC. N. PERTUTTI



docol

CÓD.	DESCRIÇÃO
4866	REGISTRO PRESSAO 3/4 DOCOL C/ACABAM PRIMOR



docol

CÓD.	DESCRIÇÃO
4875	BASE REGISTRO GAVETA 1.1/2 DOCOL
48694868	BASE REGISTRO GAVETA 1/2 DOCOL
4868	BASE REGISTRO GAVETA 3/4 DOCOL



deca

CÓD.	DESCRIÇÃO
2045	BASE REGISTRO GAVETA 1/2 4509/102
20584270	BASE REGISTRO GAVETA 3/4 4509/202
4270205	BASE REGISTRO GAVETA 1 4509/302
2057	BASE REGISTRO GAVETA 1.1/2 4509/502



deca

CÓD.	DESCRIÇÃO
2048	BASE REGISTRO PRESSAO 1/2 DECA
2059	BASE REGISTRO PRESSAO 3/4 DECA



docol

CÓD.	DESCRIÇÃO
4852	BASE REGISTRO PRESSAO 1/2 DOCOL
4853	BASE REGISTRO PRESSAO 3/4 DOCOL



deca

CÓD.	DESCRIÇÃO
2053	REGISTRO GAVETA BRUTO 1/2 1510
20522046	REGISTRO GAVETA BRUTO 3/4 1510
20462051	REGISTRO GAVETA BRUTO 1 1510
20514272	REGISTRO GAVETA BRUTO 1.1/2 1510
42724273	REGISTRO GAVETA BRUTO 1.1/4 1510
42734274	REGISTRO GAVETA BRUTO 2" 1510
4274	REGISTRO GAVETA BRUTO 2.1/2 1510



docol

CÓD.	DESCRIÇÃO
4876	REGISTRO GAVETA BRUTO 1
48564854	REGISTRO GAVETA BRUTO 1.1/2
48544855	REGISTRO GAVETA BRUTO 1/2
4855	REGISTRO GAVETA BRUTO 3/4



deca

CÓD.	DESCRIÇÃO
2055	REGISTRO ESFERA 1/2 1552
20472056	REGISTRO ESFERA 3/4
20562054	REGISTRO ESFERA 1 1552
20547500	REGISTRO ESFERA 1.1/2 1552
75007709	REGISTRO ESFERA 1.1/4 1552
7709	REGISTRO ESFERA 2 1552



THOMPSON















CÓD.	DESCRIÇÃO
3366	REGISTRO ESFERA 1/2"
33674618	REGISTRO ESFERA 3/4"
46184619	REGISTRO ESFERA 1.1/2 METAL
4619	REGISTRO ESFERA 1 METAL



docol

CÓD.	DESCRIÇÃO
4846	REGISTRO ESFERA 1
48574858	REGISTRO ESFERA 1/2
4858	REGISTRO ESFERA 3/4

HIDRÁULICA

		
<p>CÓD. DESCRIÇÃO</p> <p>5173 REGISTRO PRESSÃO 3/4 PVC 25MM 5174 REGISTRO PRESSÃO 1/2 PVC 20MM</p>	<p>CÓD. DESCRIÇÃO</p> <p>3721 REGISTRO ESFERA MAQUI. LAVAR BRANCO 1/2X3/4</p>	<p>CÓD. DESCRIÇÃO</p> <p>3761 REGISTRO ESFERA MAQUI. LAVAR METAL 1/2X3/4</p>
		
<p>CÓD. DESCRIÇÃO</p> <p>2401 REGISTRO MAQUINA LAVAR 1/2"X3/4"</p>	<p>CÓD. DESCRIÇÃO</p> <p>4860 ACAB. P/ VALV DESC SALVAGUA BOX CROM.</p>	<p>CÓD. DESCRIÇÃO</p> <p>4874 ACAB. P/ VAL. DESC. DOCOLFLAT CROMAD</p>
		
<p>CÓD. DESCRIÇÃO</p> <p>3726 ACABAMENTO ABS CROM/PRETO P/VAL.DESC DOCOL 3727 ACABAMENTO ABS CROMADO P/VALV. DESC. DOCOL</p>	<p>CÓD. DESCRIÇÃO</p> <p>4872 ACAB. P/ VALV DESCARGA ESPECIAL BEGE 4873 ACAB. P/ VALV DESCARGA ESPECIAL CINZA 4871 ACAB. P/ VALV DESCARGA ESPECIAL GELO</p>	<p>CÓD. DESCRIÇÃO</p> <p>4847 ACAB. P/ VALV DESC SALVAGUA CLA CROM.</p>
		
<p>CÓD. DESCRIÇÃO</p> <p>4844 ACAB. P/ VALVULA DESCARGA CROMADA 4870 ACAB. P/ VAL. DESCARGA CROMADO/PRETO</p>	<p>CÓD. DESCRIÇÃO</p> <p>4877 ACAB. MONOCOMANDO P/ CHUV. 3/4 NEXUS</p>	<p>CÓD. DESCRIÇÃO</p> <p>1342 ACABA. ABS BEGE P/VALV. DESC. HYDRA 1195 ACABA. ABS CROMADO P/VALV. DESC. HYDRA 1196 ACABA. ABS GELO P/VALV. DESC. HYDRA</p>
		
<p>CÓD. DESCRIÇÃO</p> <p>7820 ACABAMENTO ABS PRETO P/VALVULA HYDRA</p>	<p>CÓD. DESCRIÇÃO</p> <p>2061 ACABAMENTO PARA VÁL. HYDRA MAX BEGE 2062 ACABAMENTO PARA VÁL. HYDRA MAX BRANCO 2063 ACABAMENTO PARA VÁL. HYDRA MAX CINZA 2064 ACABAMENTO PARA VÁL. HYDRA MAX CROMADA</p>	<p>CÓD. DESCRIÇÃO</p> <p>4271 KIT CONVERSOR HYDRA MAX P/ HYDRA PLUS DECA</p>

HIDRÁULICA



deca

CÓD. DESCRIÇÃO
5646 KIT CONVERSOR HYDRA MAX P/ HYDRA DUO DECA



docol

CÓD. DESCRIÇÃO
4843 BASE VÁLVULA DESCARGA DOCOL 1.1/2



deca

CÓD. DESCRIÇÃO
5695 BASE MONOCOMANDO P/ CHUVEIRO B. PRES. DECA



deca

CÓD. DESCRIÇÃO
2060 BASE VALVULA DESCARGA HYDRA MAX 1.1/2 DECA



docol

CÓD. DESCRIÇÃO
4865 BASE MIST. DOCOL MONOCOMANDO CHUVEIRO 3/4



docol

CÓD. DESCRIÇÃO
4848 BASE MISTURADOR DOCOL CHUVEIRO 3/4 X 1/2



deca

CÓD. DESCRIÇÃO
2044 BASE MISTURADOR DECA CHUVEIRO CRM 3/4 X 1/2



docol

CÓD. DESCRIÇÃO
5135 VÁLVULA RETENÇÃO UNIVERSAL - DN20 (3/4")
5136 VÁLVULA RETENÇÃO UNIVERSAL - DN25 (1")
5137 VALVULA RETENCAO UNIVERSAL DN40(1.1/2")



docol

CÓD. DESCRIÇÃO
5138 VÁLVULA DE SUÇÃO - DN20 (3/4")
5139 VÁLVULA DE SUÇÃO - DN25 (1")
5140 VÁLVULA DE SUÇÃO - DN40 (1.1/2")



deca

CÓD. DESCRIÇÃO
8003 RETENTOR HYDRAMAX



Blukit

CÓD. DESCRIÇÃO
3729 RETENTOR P/ EIXO VALVULA DESCARGA HYDRA MAX



deca

CÓD. DESCRIÇÃO
2084 REPARO ORIG. P/ VALV. MOD. 4 TIPOS4676/874



deca

CÓD. DESCRIÇÃO
2083 REPARO VALV. DESCARGA LUXO/MASTER 4686/924



Blukit

CÓD. DESCRIÇÃO
1197 KIT REPARO P/VALV. DESCARGA HYDRA MAX



deca

CÓD. DESCRIÇÃO
2082 REPARO ORIG. P/ VALV. HYDRA MAX 4686

HIDRÁULICA



Blukit

CÓD. DESCRIÇÃO
3797 REPARO P/VALV. DESCARGA DOCOL RI-484



Blukit

CÓD. DESCRIÇÃO
3732 REPARO P/VALV. DESCARGA LUXO/MASTER



CÓD. DESCRIÇÃO
3728 REPARO P/VALV. DESCARGA UNIFICADO



Blukit

CÓD. DESCRIÇÃO
1198 KIT ACIONADOR. P/VALV. DESC. LUXO/MASTER



Blukit

CÓD. DESCRIÇÃO
3731 SEDE P/ VALVULA DESCARGA HYDRAMAX



deca

CÓD. DESCRIÇÃO
8002 SEDE PARA VÁLVULA HYDRAMAX



Blukit

CÓD. DESCRIÇÃO
3730 CONTRA SEDE P/ VALVULA DESCARGA HYDRA MAX

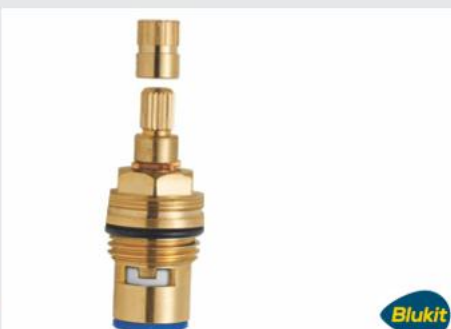

Blukit

CÓD. DESCRIÇÃO
3763 MVS P/ TORN. 1/4 VOLTA UNIVERSAL

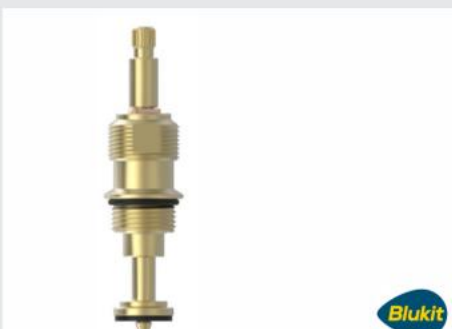

Blukit

CÓD. DESCRIÇÃO
3734 MVS P/ REG. PRESSÃO DOCOL

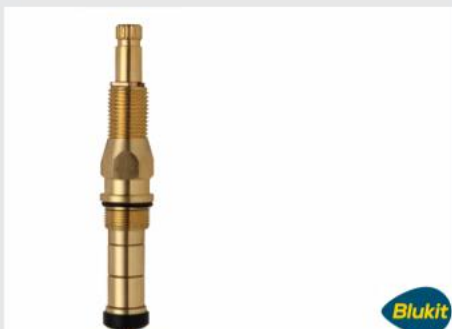

Blukit

CÓD. DESCRIÇÃO
1439 KIT FÁCIL P/TORNEIRA N. 00 BLISTER



Blukit

CÓD. DESCRIÇÃO
3733 MVS P/ REG. PRESSÃO DECA 1/2 E 3/4



Blukit

CÓD. DESCRIÇÃO
3758 CONVERSOR PARA REGISTRO DECA X DOCOL



Blukit

CÓD. DESCRIÇÃO
3757 CONVERSOR PARA REGISTRO DOCOL X DECA



Blukit

CÓD. DESCRIÇÃO
5078 KIT FACIL P/ REGISTRO 9 EM 1 PPS BLISTER



Garden
qualidade e resistência

CÓD. DESCRIÇÃO
2782 EXTENSÃO CROMADA CURTA 1/2
27852784 EXTENSÃO CROMADA CURTA 3/4
27842787 EXTENSÃO CROMADA LONGA 1/2
27872783 EXTENSÃO CROMADA LONGA 3/4
27832786 EXTENSÃO CROMADA MÉDIA 1/2
2786 EXTENSÃO CROMADA MÉDIA 3/4

HIDRÁULICA



Garden
qualidade e resistência

CÓD.	DESCRIÇÃO
8932	EXTENSÃO AMARELA METAL 1/2 CURTO
89348933	EXTENSÃO AMARELA METAL 1/2 MÉDIO
8933	EXTENSÃO AMARELA METAL 1/2 LONGO

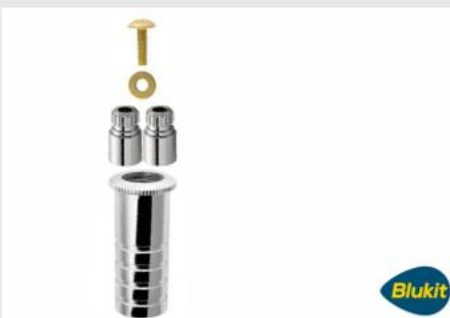

Blukit

CÓD.	DESCRIÇÃO
3759	PROLONGADOR CROMADO P/REG. DECA 20,0 MM
3760	PROLONGADOR CROMADO P/REG. DECA 40,0 MM

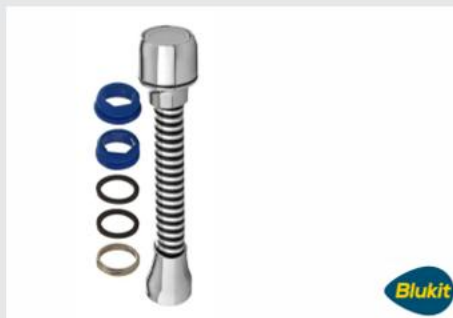

Blukit

CÓD.	DESCRIÇÃO
3755	EXTENSOR C/ AREJADOR P/TORNEIRAS ROSCA 90
3756	EXTENSOR C/ AREJADOR P/TORNEIRAS ROSCA 140



ASTRA

CÓD.	DESCRIÇÃO
6991	ENGATE 40 CM FLEXIVEL
6992	ENGATE 50 CM FLEXIVEL
6993	ENGATE 60 CM FLEXIVEL



Mantac

CÓD.	DESCRIÇÃO
6167	ENGATE 40 CM FLEX BRANCO MANTAC
6169	ENGATE 60 CM FLEX BRANCO MANTAC



ASTRA

CÓD.	DESCRIÇÃO
6674	ENGATE 40 CM PRETO FLEXIVEL



FORTLEV

CÓD.	DESCRIÇÃO
7254	ENGATE 40 CM BRANCO FLEXIVEL FORTLEV
7255	ENGATE 60 CM BRANCO FLEXIVEL FORTLEV



Blukit

CÓD.	DESCRIÇÃO
4371	VALVULA MICTORIO C/ CAN. E FLEX. 30CM BRANCA
4372	VALVULA MICTORIO C/ CAN. E FLEX. 30CM CROMA.



BOMVINK

CÓD.	DESCRIÇÃO
8318	DUCHA HIGIÊNICA CROMADA METAL



MEGA
IMPORTADORA

CÓD.	DESCRIÇÃO
1069	DUCHA HIGIÊNICA C-25



BOMVINK

CÓD.	DESCRIÇÃO
8568	DUCHA HIGIÊNICA CROMADA



VALEPLAST

CÓD.	DESCRIÇÃO
1680	DUCHA FRIA VALE MAXI 4" BRANCA
16831680	DUCHA FRIA VALE MAXI 7" BRANCA
3465	DUCHA FRIA VALE MAXI 10" BRANCA



VALEPLAST

CÓD.	DESCRIÇÃO
1682	DUCHA FRIA VALE MAXI 4" METALIZADA
16831680	DUCHA FRIA VALE MAXI 7" METALIZADA
1684	DUCHA FRIA VALE MAXI 10" METALIZADA



BOMVINK

CÓD.	DESCRIÇÃO
8355	KIT DUCHA INOX QUAD. 20CM C/ CANO RED. 40CM



BOMVINK

CÓD.	DESCRIÇÃO
8874	KIT DUCHA INOX 20CM C/ CANO QUADR. 40 CM CR.

HIDRÁULICA



etaniz

CÓD. DESCRIÇÃO
8316 LUBRIFICANTE SPRAY P/ TUBOS E PVC 250 ML



TEK BOND
SAINT-GOBAIN

CÓD. DESCRIÇÃO
7682 FITA VEDA ROSCA 12MMX10M
76847685 FITA VEDA ROSCA 18MMX25M
7685 FITA VEDA ROSCA 18MMX50M



SEAL TAPE

CÓD. DESCRIÇÃO
1094 FITA VEDA ROSCA POLYFITA 12MMX10M
10958038 FITA VEDA ROSCA POLYFITA 12MMX25M
80386363 FITA VEDA ROSCA POLYFITA 12MMX50M
6363 FITA VEDA ROSCA POLYFITA 12MMX5M



BOMVINK

CÓD. DESCRIÇÃO
8496 CHAVE AJUSTÁVEL PARA ENCANAMENTO



BOMVINK

CÓD. DESCRIÇÃO
8116 CHAVE HIDRÁULICA MULTIFUNCCIONAL



IRRIGAÇÃO

RIP
REBOUCAS

CÓD. DESCRIÇÃO
7421 REGISTRO ESFERA UNIAO DENTADA 1/2 IRRIGACAO
7422 REGISTRO ESFERA UNIAO DENTADA 3/4 IRRIGACAO
7423 REGISTRO ESFERA UNIAO DENTADA 1 IRRIGACAO



RIP
REBOUCAS

CÓD. DESCRIÇÃO
18441845 JOELHO INTER. DUPLO 1/2 JO57N
18451846 JOELHO INTER. DUPLO 3/4 JO58N
1846 JOELHO INTER. DUPLO 1" JO59N



RIP
REBOUCAS

CÓD. DESCRIÇÃO
1847 TEE INTER. 1/2 TE51N
18481849 TEE INTER. 3/4 TE52NTEE INTER. 1 TE53N
18491850 TEE INTER. 1 TE53NTEE INTER. 1.1/2 TE55N
18501851 TEE INTER. 1.1/2 TE55NTEE INTER. 2 TE56N
1851 TEE INTER. 2 TE56N



RIP
REBOUCAS

CÓD. DESCRIÇÃO
1833 ADAPTADOR INTER. 1/2 AD51N
18341835 ADAPTADOR INTER. 3/4 AD52N
18351836 ADAPTADOR INTER. 1 AD53N
18361837 ADAPTADOR INTER. 3/4 X 1/2 AD54N
18371838 ADAPTADOR INTER. 1 X 3/4 AD55N
18381839 ADAPTADOR INTER. 1.1/2 AD57N
1839 ADAPTADOR INTER. 2 AD58N



RIP
REBOUCAS

CÓD. DESCRIÇÃO
1852 TEE INTER. TRIPLIO 1/2 TE57N
1853 TEE INTER. TRIPLIO 3/4 TE58N
1854 TEE INTER. TRIPLIO 1" TE59N



RIP
REBOUCAS

CÓD. DESCRIÇÃO
1840 JOELHO INTER. 1/2 JO51N
18411842 JOELHO INTER. 3/4 JO52NJOELHO INTER. 1 JO53N
18421868 JOELHO INTER. 1 JO53NJOELHO INTER. 1.1/2 JO54N
18681843 JOELHO INTER. 1.1/2 JO55NJOELHO INTER. 2 JO56N
1843 JOELHO INTER. 2 JO56N



RIP
REBOUCAS

CÓD. DESCRIÇÃO
1855 UNIAO INTER. 3/8 UN50N
18561857 UNIAO INTER. 1/2 UN51N
18571858 UNIAO INTER. 3/4 UN52N
18581859 UNIAO INTER. 1 UN53N
18591860 UNIAO INTER. 3/4 X 1/2 UN54N
18601861 UNIAO INTER. 1 X 3/4 UN55N
18611862 UNIAO INTER. 1.1/2 UN57N
1862 UNIAO INTER. 2 UN58N



FORTLEV

CÓD. DESCRIÇÃO
865 TE AZUL SOLD 20X1/2 BCH LT
866 TE AZUL SOLD 25X1/2 BCH LT
867 TE AZUL SOLD 25X3/4 BCH LT



FORTLEV

CÓD. DESCRIÇÃO
859 JOELHO AZUL 90 SOLD 20X1/2 BUCHA LT
860 JOELHO AZUL 90 SOLD 25X1/2 BUCHA LT
861 JOELHO AZUL 90 SOLD 25X3/4 BUCHA LT



FORTLEV

CÓD. DESCRIÇÃO
862 LUVA AZUL SOLD 20X1/2 BCH LT
863 LUVA AZUL SOLD 25X1/2 BCH LT
864 LUVA AZUL SOLD 25X3/4 BCH LT

HIDRÁULICA



ATLAS
PNEUMÁTICA E FERRAMENTAS

CÓD. DESCRIÇÃO
5362 PORTA SHAMPOO CANTO FACIL 215X215 BRANCO



HIDRÁULICA
MATERIAIS E COCINAS

CÓD. DESCRIÇÃO
5247 PORTA SHAMPOO INOX RETO 30X10CM VIDRO 6MM



HIDRÁULICA
MATERIAIS E COCINAS

CÓD. DESCRIÇÃO
5248 PORTA SHAMPOO INOX CANTO 20CM VIDRO 06MM



VALEPLAST

CÓD. DESCRIÇÃO
1710 SABONETEIRA BEGE
17091711 SABONETEIRA BRANCA
17111712 SABONETEIRA CINZA
17121714 SABONETEIRA CRISTAL
1714 SABONETEIRA FUMÊ



HIDRÁULICA
MATERIAIS E COCINAS

CÓD. DESCRIÇÃO
3112 SABONETEIRA PAREDE INOX FAETTO



ASTRA

CÓD. DESCRIÇÃO
5270 PORTA SABONETE LIQUIDO PLASTICO DE MESA



VALEPLAST

CÓD. DESCRIÇÃO
1700 PAPELEIRA C/PROT. FLORENÇA BEGE
16991708 PAPELEIRA C/PROT. FLORENÇA BRANCO
17011704 PAPELEIRA C/PROT. FLORENÇA CINZA
17042128 PAPELEIRA C/PROT. FLORENÇA FUMÊ
2121 PAPELEIRA C/PROT. FLORENÇA CROMADO



HIDRÁULICA
MATERIAIS E COCINAS

CÓD. DESCRIÇÃO
3109 PAPELEIRA SEM TAMPA INOX FAETTO



HIDRÁULICA
MATERIAIS E COCINAS

CÓD. DESCRIÇÃO
3108 PAPELEIRA COM TAMPA INOX FAETTO



VALEPLAST

CÓD. DESCRIÇÃO
1706 PAPELEIRA S/PROT. FLORENÇA BEGE
17051707 PAPELEIRA S/PROT. FLORENÇA BRANCO
17071703 PAPELEIRA S/PROT. FLORENÇA CINZA
1708 PAPELEIRA S/PROT. FLORENÇA CROMADO



ASTRA

CÓD. DESCRIÇÃO
5271 ROLETE PARA PAPEL HIGIÊNICO



HIDRÁULICA
MATERIAIS E COCINAS

CÓD. DESCRIÇÃO
3111 PORTA TOALHA INOX RETO



VALEPLAST

CÓD. DESCRIÇÃO
1692 PORTA TOALHA BANHO BEGE
16911693 PORTA TOALHA BANHO BRANCO
16931694 PORTA TOALHA BANHO CINZA
1694 PORTA TOALHA BANHO CROMADO



VALEPLAST

CÓD. DESCRIÇÃO
1696 PORTA TOALHA ROSTO BEGE
16951697 PORTA TOALHA ROSTO BRANCO
16971698 PORTA TOALHA ROSTO CINZA
1698 PORTA TOALHA ROSTO CROMADO



HIDRÁULICA
MATERIAIS E COCINAS

CÓD. DESCRIÇÃO
3110 PORTA TOALHA ARGOLA INOX FAETTO

HIDRÁULICA



Vildrex
Praticidade & Elegância

CÓD. DESCRIÇÃO
5794 KIT P/ BANHEIRO LUXO CANTO VERDE DECORE



HIDRO LAR
BANHEIRO & COZINHA

CÓD. DESCRIÇÃO
3107 CABIDE DUPLO INOX FAETTO



VALEPLAST

CÓD. DESCRIÇÃO
1688 CABIDE BEGE
16871689 CABIDE BRANCO
16891690 CABIDE CINZACABIDE CR
1690 CABIDE CROMADO



ASTRA

CÓD. DESCRIÇÃO
5536 PORTA SHAMPOO ALTO C/ GANCHO PLAST BRANCO



VALEPLAST

CÓD. DESCRIÇÃO
1716 PORTA SHAMPOO OPACO BEGE
17151717 PORTA SHAMPOO OPACO BRANCO
1717 PORTA SHAMPOO OPACO CINZA



ASTRA

CÓD. DESCRIÇÃO
4535 ARMARIO P/ BANHEIRO 28, 6x41x9, 5CM ASTRA



VALEPLAST

CÓD. DESCRIÇÃO
1677 ARMÁRIO P/ BANHEIRO BRANCO
1679 ARMÁRIO P/ BANHEIRO CINZA



ATLAS
PRATICIDADE E CONFORTO

CÓD. DESCRIÇÃO
4929 ARMARIO P/BANHEIRO BRANCO 30X37X9,5CM



ATLAS
PRATICIDADE E CONFORTO

CÓD. DESCRIÇÃO
5363 ARMARIO BASICO TOAILETE PLASTICO BRANCO



DUAL
PLÁSTICOS

CÓD. DESCRIÇÃO
7626 ARMARIO PARA BANHEIRO IMP. BR. 35X39X10CM



deca

CÓD. DESCRIÇÃO
8086 VEDANTE TORNEIRA/REGISTRO PRESSÃO



FORTLEV

CÓD. DESCRIÇÃO
6643 TAMPA DE CAIXA D'AGUA 500L



ATLAS
PRATICIDADE E CONFORTO

CÓD. DESCRIÇÃO
5355 TAPETE BANHO 48X32CM PLÁSTICO TRANSPARENTE



BOMVINK

CÓD. DESCRIÇÃO
8817 ESCOVA SANITÁRIA INOX PARA BANHEIRO

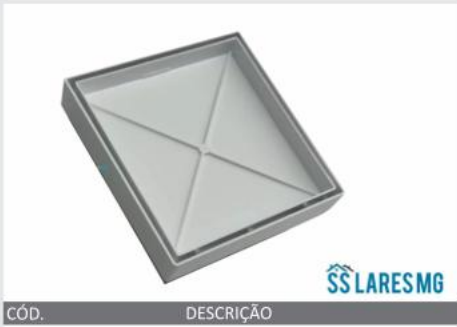

SSLARES MG

CÓD. DESCRIÇÃO
6394 RALO INVISÍVEL OCULTO 150MM BRANCO
7380 RALO INVISÍVEL OCULTO 150MM CINZA

ULTRA
/// METAIS

CATÁLOGO DE PRODUTOS

2026

● LINHA LINK



CÓDIGO 7915
TORNEIRA LINK PRETA 45°
1/4 ALTA



CÓDIGO 7308
TORNEIRA LINK PRETA 90°
1/4 ALTA



CÓDIGO 7307
TORNEIRA LINK
PRETA 45o 1/4V
BAIXA



CÓDIGO 3015
TORNEIRA LINK 45° 1/4V
ALTA 1198



CÓDIGO 3016
TORNEIRA LINK 90° 1/4
ALTA 1199



CÓDIGO 3014
TORNEIRA LINK
45° 1/4V
BAIXA 1197



● LINHA MONOCOMANDO COZINHA



CÓDIGO 7508
MISTURADOR MONO
C/ JATO FLEXÍVEL
CROMADO



CÓDIGO 7481
MISTURADOR MONO
C/ JATO FLEXÍVEL
PRETO



CÓDIGO 6990
MISTURADOR
MONOCOMANDO
COZINHA FLEX

*Tubo 46

● LINHA COZINHA



CÓDIGO 5779
TORNEIRA 1169
BM METAL
PIA MESA C40



CÓDIGO 2189
TORNEIRA GOURMET
METAL 1/4
MESA CACHIMBO



*Tubo 48



CÓDIGO 5181
TORNEIRA 1169 BM
METAL PIA/MESA C-33



CÓDIGO 5778
TORNEIRA 1168
BM METAL PIA/
PAREDE C40



CÓDIGO 2188
TORNEIRA GOURMET
METAL 1/4
PAREDE CACHIMBO



*Tubo 48



CÓDIGO 5180
TORNEIRA 1168 BM
METAL PIA/PAREDE
C-33





CÓDIGO 2198
TORNEIRA 1168
BM METAL
PIA/PAREDE C-50



CÓDIGO 2201
TORNEIRA 1168 BM
1/4 PIA/PAREDE
CACHIMBO



CÓDIGO 5181
TORNEIRA 1169
BM METAL
PIA MESA C-33



CÓDIGO 2199
TORNEIRA 1169 BM
METAL
PIA MESA C-50



CÓDIGO 2202
TORNEIRA 1169 BM
1/4 METAL PIA MESA
CACHIMBO



● LINHA COZINHA (LUXO)



CÓDIGO 3084
TORNEIRA 1168 LUXO
BM PIA/PAREDE C-50



CÓDIGO 3063
TORNEIRA 1168
LUXO BM
1/4 METAL
PIA PAREDE



CÓDIGO 3064
TORNEIRA 1169
LUXO BM 1/4
METAL PIA MESA
CACHIMBO



CÓDIGO 3085
TORNEIRA 1169 LUXO
BM PIA MESA C-50

● LINHA QUADRADA COZINHA (LUXO)



CÓDIGO 6185
TORNEIRA 1168
QUADRADA
LUXO PIA PAREDE



CÓDIGO 6186
TORNEIRA 1195
QUADRADA
LUXO LAVATÓRIO MESA



CÓDIGO 6187
TORNEIRA 1169
QUADRADA
LUXO PIA MESA



● MISTURADOR



CÓDIGO 6184
MISTURADOR
MESA BM
C/AREJADOR
ARTICULADO



CÓDIGO 6183
MISTURADOR
PAREDE BM
C/AREJADOR
ARTICULADO

● BICA BAIXA



CÓDIGO 4518
TORNEIRA 1168 BICA BAIXA
1/4 METAL PIA PAREDE



CÓDIGO 4517
TORNEIRA 1168 BICA BAIXA
1/4 METAL PIA PAREDE C-50



● LAVATÓRIO



CÓDIGO 2200
TORNEIRA 1195 BM METAL
LAVATÓRIO C-50



CÓDIGO 5182
TORNEIRA 1195
BM METAL
LAVATÓRIO/MESA C-33



CÓDIGO 5780
TORNEIRA 1195
BM METAL
LAVATÓRIO C-40



CÓDIGO 2203
TORNEIRA 1195 BM 1/4
METAL LAVA. MESA CA.



CÓDIGO 2196
TORNEIRA 1193 METAL
LAVATORIO C-33

● LAVATÓRIO TEMPORIZADOR



CÓDIGO 2601
TORNEIRA LAVATÓRIO
TEMPORIZADA

● BEBEDOURO



CÓDIGO 7687
TORNEIRA BEBEDOURO 1110
METAL CROMADA

● LINHA LAVATÓRIO (LUXO)



CÓDIGO 3083
TORNEIRA 1195
LUXO BM
LAVATÓRIO/MESA
C-50



CÓDIGO 3065
TORNEIRA 1195
LUXO BM 1/4
LAVATÓRIO/MESA
CACHIMBO



CÓDIGO 2197
TORNEIRA 1194 METAL
LAVATÓRIO LUXO V-50



CÓDIGO 7891
TORNEIRA LAVATÓRIO
METAL
DESQ-308 CROMADA



CÓDIGO 7892
TORNEIRA LAVATÓRIO
METAL
DESQ-308 PRETA



● LINHA COLOR (GOURMET)



CÓDIGO 7517
TORNEIRA COLORIDA PAREDE
TUBO GOURMET CINZA



* Tubo 50



CÓDIGO 4192
TORNEIRA COLORIDA PAREDE
TUBO GOURMET VERMELHO



* Tubo 50



CÓDIGO 4193
TORNEIRA COLORIDA PAREDE
TUBO GOURMET PRETA



* Tubo 50



CÓDIGO 7518
TORNEIRA COLORIDA MESA
TUBO GOURMET CINZA



* Tubo 50



CÓDIGO 4194
TORNEIRA COLORIDA MESA
TUBO GOURMET VERMELHO



* Tubo 50



CÓDIGO 4195
TORNEIRA COLORIDA MESA
TUBO GOURMET PRETA



* Tubo 50

● LINHA COM FILTRO



CÓDIGO 2706
TORNEIRA COM
FILTRO MESA METAL
CROMADO C-50



CÓDIGO 8366
TORNEIRA COM FILTRO
MESA METAL
T. GOURMET 1/4



* Tubo 50



CÓDIGO 8021
TORNEIRA COM
FILTRO MESA
METAL
1/4 CACHIMBO





CÓDIGO 8413
TORNEIRA COM
FILTRO MESA TUBO
PRETO 1/4



CÓDIGO 8014
TORNEIRA COM
FILTRO PAREDE
TUBO PRETO 1/4



CÓDIGO 8365
TORNEIRA COM FILTRO
PAREDE METAL
T. GOURMET 1/4



CÓDIGO 2705
TORNEIRA COM
FILTRO PAREDE
METAL CROM.
C-50



CÓDIGO 8020
TORNEIRA COM FILTRO
PAREDE 1/4 CACHIMBO



● LAVANDERIA/JARDIM



CÓDIGO 2191
TORNEIRA 1130 METAL
AMARELA JARDIM



CÓDIGO 2190
TORNEIRA 1130 METAL
CROMADA JARDIM



CÓDIGO 4516
TORNEIRA 1130 LUXO
1/4 METAL



CÓDIGO 2208
TORNEIRA 1131 METAL
TANQUE/MÁQUINA
C-33



CÓDIGO 6465
TORNEIRA 1131 COM
3 SAIDAS TANQUE/MÁQUINA
C-33



CÓDIGO 2194
TORNEIRA 1159 METAL COM BICO C-33 22CM

CÓDIGO 2195
TORNEIRA 1159 METAL SEM BICO C-33 22CM

CÓDIGO 4385
TORNEIRA 1159 METAL COM BICO AREJADO C-33 22CM



CÓDIGO 2192
TORNEIRA 1158 METAL COM BICO C-33 18CM

CÓDIGO 2193
TORNEIRA 1158 METAL SEM BICO C-33 18CM

CÓDIGO 5014
TORNEIRA 1158 METAL COM BICO AREJADO C-33 22CM

● **ESFERA**



CÓDIGO 2604
TORNEIRA ESFERA 1/2
TANQUE/MÁQUINA LAVAR



CÓDIGO 6686
TORNEIRA ESFERA
CADEADO 1/2



CÓDIGO 2204
TORNEIRA
ESFERA 1/2

● **TORNEIRAS EM ABS**



CÓDIGO 7306
TORNEIRA ABS BRANCA
TANQUE/MÁQUINA



CÓDIGO 7156
TORNEIRA ABS BRANCA
JARDIM 1130



CÓDIGO 7160
TORNEIRA ABS BRANCA
COZINHA/PAREDE 1158



CÓDIGO 7161
TORNEIRA ABS BRANCA
COZINHA MESA BM



CÓDIGO 7159
TORNEIRA ABS BRANCA
COZINHA MESA BM



CÓDIGO 7158
TORNEIRA ABS
BRANCA
LAVATÓRIO
BICA MÓVEL
MESA



CÓDIGO 7157
TORNEIRA ABS BRANCA
LAVATÓRIO FIXA



CÓDIGO 7309
TORNEIRA ABS BRANC
ALAVANCA C-87



CÓDIGO 8411
TORNEIRA
COM FILTRO
MESA ABS
CROMADO



CÓDIGO 9043
TORNEIRA ABS COLOR PAREDE PRETA

CÓDIGO 9042
TORNEIRA ABS COLOR PAREDE VERMELHO



CÓDIGO 9044
TORNEIRA ABS COLOR MESA PRETA

CÓDIGO 9045
TORNEIRA ABS COLOR MESA VERMELHA

● **REGISTROS**



CÓDIGO 5291
REGISTRO ESFERA
MÁQUINA
LAVAR METAL 1/2



CÓDIGO 7519
REGISTRO DUPLO
BINÓCULO METAL
CROMADO



CÓDIGO 8500
REGISTRO DUPLO
BINÓCULO METAL
PRETO

GÁS



CÓDIGO 6705
REGISTRO DE GÁS 1/2
NPTM ANGULAR 90º



CÓDIGO 6815 REGISTRO ESFERA 1/2 METAL
CÓDIGO 6816 REGISTRO ESFERA 3/4 METAL
CÓDIGO 6817 REGISTRO ESFERA 1 METAL
CÓDIGO 6818 REGISTRO ESFERA 1.1/2 METAL



CÓDIGO 6505
REGISTRO PARA
FILTRO METAL 1147

● **ACABAMENTOS**



CÓDIGO 5154
ACABAMENTO CRUZ
DE MALTA PARA REGISTRO
1/2 OU 3/4



CÓDIGO 6292
ACABAMENTO C-33 PARA
REGISTRO 1/2 OU 3/4



CÓDIGO 2206
ACABAMENTO C-50 PARA
REGISTRO 1/2 OU 3/4



CÓDIGO 5155
ACABAMENTO CRUZ
DE MALTA PARA REGISTRO
1.1/2



CÓDIGO 6293
ACABAMENTO C-33 PARA
REGISTRO 1.1/2



CÓDIGO 2207
ACABAMENTO C-50 PARA
REGISTRO 1.1/2



CÓDIGO 2603
ACABAMENTO C-40 PARA
REGISTRO 1/2 OU 3/4



CÓDIGO 5569
ACABAMENTO QUADRADO
CROMADO PARA REGISTRO
1.1/2



CÓDIGO 6287
ACABAMENTO QUADRADO
PRETO ABS PARA REGISTRO
1/2 E 3/4

CÓDIGO 2602
ACABAMENTO C-40 PARA
REGISTRO 1.1/2

CÓDIGO 5161
ACABAMENTO QUADRADO
CROMADO PARA REGISTRO
1/2 OU 3/4

CÓDIGO 6288
ACABAMENTO QUADRADO
PRETO ABS PARA REGISTRO
1.1/2

● **Reparos E Reposições**



CÓDIGO 8368
CHAVETA CROMADA PARA
TORNEIRA METAL



CÓDIGO 8367
CHAVETA AMARELA PARA
TORNEIRA METAL



CÓDIGO 7353
CANO INOX PARA DUCHA
QUADRADA 40 CM



CÓDIGO 7352
DUCHA INOX QUADRADA
20 CM METAIS



CÓDIGO 7686
KIT FÁCIL SALVA REGISTRO
10 EM 1



CÓDIGO 3401
REPARO UNIVERSAL 1/4
VOLTA PARA TORNEIRA
M18



CÓDIGO 3402
REPARO UNIVERSAL PARA
TORNEIRAS M18



CÓDIGO 3765
GATILHO CROMADO
ABS DUCHA HIGIÊNICA



CÓDIGO 2589
VELA PARA FILTRO



CÓDIGO 4515
VEDANTE 1/2 COM PINO
NYLON COM BORRACHA



CÓDIGO 2590
COPO FILTRO ABS
COM VELA

● DUCHA



CÓDIGO 7432
KIT DUCHA INOX QUADRADO
20 CM CROMADO COM CANO
40CM

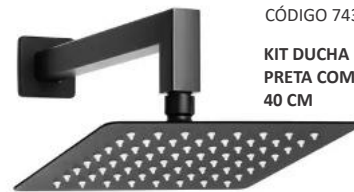

CÓDIGO 7433
KIT DUCHA INOX QUADRADO 20 CM
PRETA COM CANO
40 CM

● DUCHA HIGIÊNICA



CÓDIGO 7489
DUCHA HIGIÊNICA GATILHO
QUADRADO CROMADO



CÓDIGO 6385
DUCHA HIGIÊNICA GATILHO
QUADRADO PRETO



CÓDIGO 2205
DUCHA HIGIÊNICA CR.
1/4 CORPO ABS GATILHO
CROMADO



CÓDIGO 7434
DUCHA HIGIÊNICA CROMADO
1/4 CORPO ABS GATILHO
CROMADO



CÓDIGO 5249
DUCHA HIGIÊNICA
CROMADA
TOTAL C-50 METAL



CÓDIGO 5822
DUCHA
HIGIÊNICA
CROMADO
1/4 GATILHO
CROMADO C-25

● ENGATE



CÓDIGO 3766
ENGATE INOX 40 CM

CÓDIGO 3764
ENGATE INOX 60 CM



CÓDIGO 8025
ENGATE DUPLO PARA
MONOCOMANDO INOX



CÓDIGO 5163
ENGATE INOX 120 CM
DUCHA HIGIÊNICA

● RALO/GRELHA/PORTA GRELHA



CÓDIGO 5208
RALO CLICK 100MM
QUADRADO

CÓDIGO 5209
RALO CLICK 150MM
QUADRADO



CÓDIGO 7165
RALO CLICK 100MM
QUADRADO PRETO

CÓDIGO 7166
RALO CLICK 150MM
QUADRADO PRETO



CÓDIGO 7131
RALO CLICK 100MM
REDONDO CROMAD.



CÓDIGO 6528
PORTA GRELHA INOX
100MM QUADRADO

CÓDIGO 6945
PORTA GRELHA INOX
150MM QUADRADO



CÓDIGO 6194
GRELHA INOX
QUADRADA 10CM COM
FECHO AÇO

CÓDIGO 6944
GRELHA INOX
QUADRADA 15CM
COM FECHO AÇO



CÓDIGO 6394
RALO INVISÍVEL OCULTO
150MM BRANCO

CÓDIGO 6659
RALO INVISÍVEL OCULTO
100MM BRANCO

CÓDIGO 7380
RALO INVISÍVEL OCULTO
150MM CINZA

CÓDIGO 7381
RALO INVISÍVEL OCULTO
100MM CINZA

● VÁLVULAS



CÓDIGO 2209
VÁLVULA AMERICANA
PIA METAL



CÓDIGO 8004
VÁLVULA AMERICANA
INOX STANDART PIA



CÓDIGO 2210
VÁLVULA LAVATÓRIO
METAL



CÓDIGO 5152
VÁLVULA TANQUE METAL



CÓDIGO 7717
VÁLVULA CLICK PAR LAVATÓRIO METAL



CÓDIGO 6291
VÁLVULA LAVATÓRIO PRETA ABS



CÓDIGO 1587
VÁLVULA LAVATÓRIO ABS BRANCA V8



CÓDIGO 8100
VÁLVULA TANQUE ABS BRANCA

● SIFÕES



CÓDIGO 7492
SIFÃO UNIVERSAL BRANCO



CÓDIGO 7494
SIFÃO UNIVERSAL CROMADO



CÓDIGO 7493
SIFÃO UNIVERSAL PRETO

● TUBO LIGAÇÃO (AJUSTÁVEL)



CÓDIGO 3433
TUBO DE LIGAÇÃO INOX AJUSTÁVEL 25 CM

● BASE REGISTRO



CÓDIGO 3042
BASE REGISTRO PRESSÃO 3/4



CÓDIGO 3043
BASE REGISTRO PRESSÃO 1/2



CÓDIGO 2595
REGISTRO PRESSÃO 1/2 COM CHAVETA 1400



CÓDIGO 2596
REGISTRO PRESSÃO 3/4 COM CHAVETA 1400



CÓDIGO 2597
REGISTRO PRESSÃO 1/2 COM ACABAMENTO C-50



CÓDIGO 2598
REGISTRO PRESSÃO 3/4 COM ACABAMENTO C-50

● **REGISTRO GAVETA**



CÓDIGO 8928
REGISTRO DE GAVETA 3/4
COM ACABAMENTO C-50



CÓDIGO 4190
REGISTRO GAVETA BRUTO 1.1/2

CÓDIGO 4191
REGISTRO GAVETA BRUTO 3/4

● **KIT BANHEIRO**



CÓDIGO 3105
KIT BANHEIRO INOX
05 PCS JR. ASTI



● **ACABAMENTO ABS**



CÓDIGO 8501
ACABAMENTO ABS
BRANCO
PARA VÁLVULA
HYDRA MAX



CÓDIGO 8502
ACABAMENTO ABS
CROMADO
PARA VÁLVULA
HYDRA MAX



CÓDIGO 8503
ACABAMENTO ABS
PRETO
PARA VÁLVULA
HYDRA MAX

● **CHAVE HIDRÁULICA**



CÓDIGO 7796
CHAVE HIDRÁULICA
MULTIFUNCIONAL 10"

● **RALINHO CHINÊS**



CÓDIGO 7361
RALINHO CHINÊS 3 1/2
VÁLVULA AMERICANA POTE



CÓDIGO 7362
RALINHO CHINÊS
PIA/LAVATÓRIO/TANQUE
POTE

● **BARRA DE APOIO INOX**



CÓDIGO 9011
BARRA DE APOIO 30CM INOX
CÓDIGO 9012
BARRA DE APOIO 40CM INOX
CÓDIGO 9013
BARRA DE APOIO 50CM INOX
CÓDIGO 9014
BARRA DE APOIO 60CM INOX

FERRAGENS

ULTRA
///ATACADISTA

ULTRA

**1061 - CARRINHO
DE MÃO
QUADRADO 60L
CHAPA 24**



**2605 - RODA
COMPLETA
PARA CARRINHO
PNEU + CÂMARA**

FERRAGENS



CÓD. 7028 DESCRIÇÃO CARRINHO DE MAO 55L CHAPA 24 GALVANIZADA



CÓD. 1061 DESCRIÇÃO CARRINHO DE MAO QUADRADO 60L CHAPA 24



CÓD. 5821 DESCRIÇÃO CARRINHO DE MAO 45 LITROS PNEU E CAMARA



CÓD. 4664 DESCRIÇÃO CARRINHO DE MAO EXTRA FORTE QUADRADO 65L



CÓD. 4663 DESCRIÇÃO CARRINHO DE MÃO CAÇAMBA AZUL 50L



CÓD. 4221 DESCRIÇÃO CARRINHO DE MAO GORDINI SOFT PCI



CÓD. 9029 DESCRIÇÃO CARRINHO DE MAO CONSTRUTOR GALVANIZADO



CÓD. 7561 DESCRIÇÃO PNEU PARA CARRINHO PEDREIRO 325-8



CÓD. 6684 DESCRIÇÃO PNEU P/ CARRINHO PEDREIRO 4 LONAS 350/8



CÓD. 6683 DESCRIÇÃO PNEU P/ CARRINHO DE CARGA 250-4 / 280-4



CÓD. 2605 DESCRIÇÃO RODA COMPLETA PARA CARRINHO ULTRA



CÓD. 4062 DESCRIÇÃO RODA COMPLETA P/CARR. PNEU MACICO UN. FLEX



CÓD. 5843 DESCRIÇÃO RODA COMP. P/CAR. FORCE MACIÇO 3,25 X 8 UN.



CÓD. 8931 DESCRIÇÃO RODA COMPLETA BRANCA P/ CARRINHO 3,25X8 UNI.



CÓD. 7560 DESCRIÇÃO CÂMARA DE AR PARA CARRINHO DE MÃO 325-8

FERRAGENS



CÓD.	DESCRIÇÃO
8843	PNEU PARA CARRINHO PEDREIRO 325-8
8845	PNEU COMPLETO PARA CARRINHO PNEU + CAMARA
8844	CAMARA DE AR PARA CARRINHO DE MÃO 325-8



CÓD.	DESCRIÇÃO
7950	SUPORTE PIA PARAFUSAR PINTADO



CÓD.	DESCRIÇÃO
7949	SUPORTE PIA CHUMBAR PINTADO



CÓD.	DESCRIÇÃO
1108	SUPORTE PIA CHUMBAR
1049	SUPORTE PIA PARAFUSAR



CÓD.	DESCRIÇÃO
778	SUPORTE PRATELEIRA POIDIUM FORTE (40 CM)
77978	SUPORTE PRATELEIRA POIDIUM FORTE (50 CM)
78078	SUPORTE PRATELEIRA POIDIUM LEVE (20 CM)
78178	SUPORTE PRATELEIRA POIDIUM LEVE (25 CM)
782	SUPORTE PRATELEIRA POIDIUM LEVE (30 CM)



CÓD.	DESCRIÇÃO
3493	CANTONEIRA 05 X 06 (BRANCA)
4064	CANTONEIRA 06 X 08 (BRANCA)



CÓD.	DESCRIÇÃO
5366	SUPORTE CORTINA 0,7 X 1,2M ALUMINIO BR.



CÓD.	DESCRIÇÃO
5132	SUPORTE TV ARTICULADO 10/42" 2 MOV



CÓD.	DESCRIÇÃO
1818	SUPORTE TV ARTICULADO 10/42" 4 MOV



CÓD.	DESCRIÇÃO
4071	SUPORTE MICROONDAS BRANCO



CÓD.	DESCRIÇÃO
8545	SUPORTE TV 14" A 105" LED, PLASMA E LCD



CÓD.	DESCRIÇÃO
5568	SUPORTE TV 10" A 71" LCD/PLASMA CANAÁ BLISTER

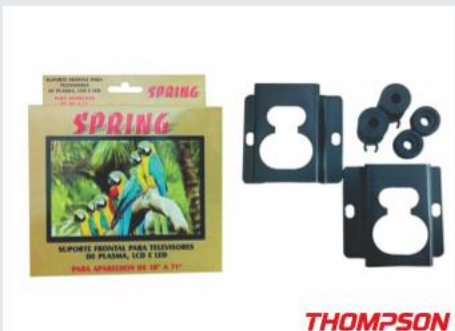

CÓD.	DESCRIÇÃO
2118	SUPORTE TV UNIV. 10" A 71" LCD/PLASMA



CÓD.	DESCRIÇÃO
3120	BARRA DE APOIO 30 CM INOX
31153113	BARRA DE APOIO 40 CM INOX
31133114	BARRA DE APOIO 60 CM INOX
31144313	BARRA DE APOIO 80 CM INOX
4313	BARRA DE APOIO 90 CM INOX

FERRAGENS

5



CÓD.	DESCRIÇÃO
1995	NÚMERO 0 ESP. 15CM
1996	NÚMERO 1 ESP. 15CM
1997	NÚMERO 2 ESP. 15CM
1998	NÚMERO 3 ESP. 15CM
1999	NÚMERO 4 ESP. 15CM
2000	NÚMERO 5 ESP. 15CM
2001	NÚMERO 6 ESP. 15CM
2002	NÚMERO 7 ESP. 15CM
2003	NÚMERO 8 ESP. 15CM
2004	NÚMERO 9 ESP. 15CM

5



CÓD.	DESCRIÇÃO
2005	NÚMERO 0 ESP. 20CM
2006	NÚMERO 1 ESP. 20CM
2007	NÚMERO 2 ESP. 20CM
2008	NÚMERO 3 ESP. 20CM
2009	NÚMERO 4 ESP. 20CM
2010	NÚMERO 5 ESP. 20CM
2011	NÚMERO 6 ESP. 20CM
2012	NÚMERO 7 ESP. 20CM
2013	NÚMERO 8 ESP. 20CM
2014	NÚMERO 9 ESP. 20CM

5



CÓD.	DESCRIÇÃO
2015	NÚMERO 0 ESP. 25CM
2016	NÚMERO 1 ESP. 25CM
2017	NÚMERO 2 ESP. 25CM
2018	NÚMERO 3 ESP. 25CM
2018	NÚMERO 3 ESP. 25CM
2019	NÚMERO 4 ESP. 25CM
2020	NÚMERO 5 ESP. 25CM
2021	NÚMERO 6 ESP. 25CM
2022	NÚMERO 7 ESP. 25CM
2023	NÚMERO 8 ESP. 25CM
2024	NÚMERO 9 ESP. 25CM

7



CÓD.	DESCRIÇÃO
7655	NÚMERO 0 INDUPLÁSTICO
7656	NÚMERO 1 INDUPLÁSTICO
7657	NÚMERO 2 INDUPLÁSTICO
7658	NÚMERO 3 INDUPLÁSTICO
7659	NÚMERO 4 INDUPLÁSTICO
7660	NÚMERO 5 INDUPLÁSTICO
7661	NÚMERO 6 INDUPLÁSTICO
7662	NÚMERO 7 INDUPLÁSTICO
7663	NÚMERO 8 INDUPLÁSTICO
7664	NÚMERO 9 INDUPLÁSTICO

3

CÓD.	DESCRIÇÃO
5458	NUMERO 0 PLAST. PRETO C/ DOURADO
5459	NUMERO 1 PLAST. PRETO C/ DOURADO
5460	NUMERO 2 PLAST. PRETO C/ DOURADO
5461	NUMERO 3 PLAST. PRETO C/ DOURADO
5462	NUMERO 4 PLAST. PRETO C/ DOURADO
5463	NUMERO 5 PLAST. PRETO C/ DOURADO
5464	NUMERO 6 PLAST. PRETO C/ DOURADO
5466	NUMERO 7 PLAST. PRETO C/ DOURADO
5465	NUMERO 8 PLAST. PRETO C/ DOURADO
5468	NUMERO 9 PLAST. PRETO C/ DOURADO



CÓD.	DESCRIÇÃO
5318	VARAL DE AÇO 10M REVESTIDO
53195320	VARAL DE AÇO 15M REVESTIDO
5320	VARAL DE AÇO 20M REVESTIDO



CÓD.	DESCRIÇÃO
2964	VARAL DE AÇO 10 M REVESTIDO
29652966	VARAL DE AÇO 15 M REVESTIDO
2966	VARAL DE AÇO 20 M REVESTIDO



CÓD.	DESCRIÇÃO
7219	VARAL DE PAREDE ARTICULADO ALUMINIO PRATICO



CÓD.	DESCRIÇÃO
7022	VARAL DE TETO ALUMINIO 1,20 X 0,56 M



CÓD.	DESCRIÇÃO
7023	VARAL DE CHAO ALUMINIO C/ ABAS 1,86 X 0,56 M



CÓD.	DESCRIÇÃO
7024	VARAL DE CHAO ALUMINIO C/ ABAS 2,06 X 0,56 M



CÓD.	DESCRIÇÃO
6191	VARAL RECOLHIVEL PRÁTICO 15 METROS
6192	VARAL RECOLHIVEL PRÁTICO 30 METROS



CÓD.	DESCRIÇÃO
2656	CANTONEIRA SEXT. BRANCA 3 M
2655	CANTONEIRA SEXT. POLIDA 3 M



CÓD.	DESCRIÇÃO
2650	CANTONEIRA L 1/2 BRANCA 3 M
26492652	CANTONEIRA L 1/2 POLIDA 3 M
26522651	CANTONEIRA L 5/8 BRANCA 3 M
26512654	CANTONEIRA L 5/8 POLIDA 3 M
26542653	CANTONEIRA L 3/4 BRANCA 3 M
26532648	CANTONEIRA L 3/4 POLIDA 3 M
26482647	CANTONEIRA L 1" BRANCA 3 M
2647	CANTONEIRA L 1" POLIDA 3 M

FERRAGENS



CÓD. DESCRIÇÃO
7025 ESCADA DOMESTICA ALUMINIO 3 DEGRAUS



CÓD. DESCRIÇÃO
7026 ESCADA DOMESTICA ALUMINIO 5 DEGRAUS



CÓD. DESCRIÇÃO
7027 ESCADA DOMESTICA ALUMINIO 7 DEGRAUS



CÓD. DESCRIÇÃO
7768 FECHADURA EXTERNA INOX PREMIUM 2600/71 IP



CÓD. DESCRIÇÃO
3262 FECHADURA STILO LATONADO BRONZE EXTERNA
32613263 FECHADURA STILO LATONADO BRONZE INTERNA
3263 FECHADURA STILO LATONADO BRONZE WC



CÓD. DESCRIÇÃO
1756 FECHADURA STILO CROMADA INTERNA
1757 FECHADURA STILO CROMADA EXTERNA
1758 FECHADURA STILO CROMADA WC



CÓD. DESCRIÇÃO
7769 FECHADURA INTERNA INOX PREMIUM 2700/71 IP



CÓD. DESCRIÇÃO
3483 FECHADURA SERRALHEIRO EXT CROMADA 21MM



CÓD. DESCRIÇÃO
6485 FECHADURA FASHION CROMADA EXTERNA
6487 FECHADURA FASHION CROMADA INTERNA
6489 FECHADURA FASHION CROMADA WC



CÓD. DESCRIÇÃO
6486 FECHADURA FASHION BRONZE ANTIQUE EXTERNA
6488 FECHADURA FASHION BRONZE ANTIQUE INTERNA
6490 FECHADURA FASHION BRONZE ANTIQUE WC



CÓD. DESCRIÇÃO
6491 FECHADURA SERRALHEIRO EXT CROMADA 21MM



CÓD. DESCRIÇÃO
7770 FECHADURA WC INOX PREMIUM 2800/71 IP



CÓD. DESCRIÇÃO
5005 FECHA INTERNA ROSETA MODENA CROMADO
5007 FECHA INTERNA ROSETA MODENA BRONZE LAT.



CÓD. DESCRIÇÃO
5004 FECHA EXTERNA ROSETA MODENA CROMADA
5008 FECHA EXTERNA ROSETA MODENA BRONZE LAT



CÓD. DESCRIÇÃO
5006 FECHA WC ROSETA MODENA CROMADO
5009 FECHA WC ROSETA MODENA BRONZE LAT.

FERRAGENS



CÓD. DESCRIÇÃO
7966 MAÇANETA FECHADURA STILO ALAVANCA BRONZE
7967 MAÇANETA FECHADURA STILO CROMADO



CÓD. DESCRIÇÃO
6492 MAÇANETA ALAVANCA CROMADA



CÓD. DESCRIÇÃO
5904 MAÇANETA ALAVANCA CROMADA SILVANA



CÓD. DESCRIÇÃO
3482 CILINDRO 40MM CROM. ENCARTELADO 2 CHAVES



CÓD. DESCRIÇÃO
2893 CILINDRO 53 MM PY 2 CHAVES P/SOPRANO
2891 CILINDRO 60 MM PY 2 CHAVES P/STAM

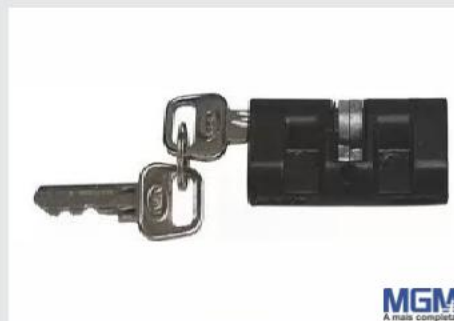

CÓD. DESCRIÇÃO
7854 CILINDRO 40MM PRETO ENCARTELADO 2 CHAVES



CÓD. DESCRIÇÃO
6457 CILINDRO REP FECH ALIANÇA 1300/1400
6458 CILINDRO REP P/FECH SOPRANO REF 500
6459 CILINDRO 60MM REP FECH STAM REF 500
6460 CILINDRO REP 50 MM FECH 3F 4000/500



CÓD. DESCRIÇÃO
7554 FECHADURA PARA GAVETA 22MM



CÓD. DESCRIÇÃO
7917 FECHADURA PADO Pv08 PORTA DE VIDRO CORRER



CÓD. DESCRIÇÃO
7918 FECHADURA PADO Pv07 JANELA DE VIDRO CORRER



CÓD. DESCRIÇÃO
6455 FECHADURA SOBREPOR PORTAO PRETO



CÓD. DESCRIÇÃO
7474 FECHADURA SOBREPOR PORTAO PRETO



CÓD. DESCRIÇÃO
6495 FECHADURA BICO PAPAGAIO BROCA 19



CÓD. DESCRIÇÃO
5814 FECHADURA AUXILIAR TETRA CROMADO ROS23



CÓD. DESCRIÇÃO
5885 DOBRADICA 850 X 1 ZINC SILVANA
5886 DOBRADICA 850 X 1.1/4 ZINC SILVANA
5887 DOBRADICA 850 X 1.1/2 ZINC SILVANA
5888 DOBRADICA 850 X 2 ZINC SILVANA
5889 DOBRADICA 850 X 2.1/2 ZINC SILVANA
5890 DOBRADICA 850 X 3 ZINC SILVANA
5891 DOBRADICA 850 X 3.1/2 ZINC SILVANA
5892 DOBRADICA 850 X 4 ZINC SILVANA

FERRAGENS



Silvana

CÓD.	DESCRIÇÃO
5905	DOBRADICA SILVANA 3 1/2 ZINCADA (CARTELA 3 UN.)
5906	DOBRADICA SILVANA 3 1/2 BRONZE (CARTELA 3 UN.)



**NOVA
PILAR
FERRAGENS**

CÓD.	DESCRIÇÃO
997	DOBRADIÇA 3 1/2 LATONADA BRONZE (CTL 3 UNI.)
996	DOBRADIÇA 3 1/2 ZINCADA (CTL 3 UNI.)



BOMVINK

CÓD.	DESCRIÇÃO
8842	DOBRADIÇA BOMVINK 3,5" ZINCADA (3 PEÇAS)



BOMVINK

CÓD.	DESCRIÇÃO
8455	DOBRADIÇA 2" ZINCADA (3 PEÇAS)



BOMVINK

CÓD.	DESCRIÇÃO
8456	DOBRADIÇA 2,6 ZINCADA (3 PEÇAS)



BOMVINK

CÓD.	DESCRIÇÃO
8466	DOBRADIÇA 4" ZINCADA (3 PEÇAS)



SOPRANO

CÓD.	DESCRIÇÃO
5900	DOBRADICA PORTA CADEADO 300 X 2.1/2 ZINC.
5901	DOBRADICA PORTA CADEADO 300 X 3.1/2 ZINC.



Silvana

CÓD.	DESCRIÇÃO
5893	FERROLHO 460 X 3 ZINCADO SILVANA
58945895	FERROLHO 460 X 4 ZINCADO SILVANA
5895	FERROLHO 460 X 5 ZINCADO SILVANA



BOMVINK

CÓD.	DESCRIÇÃO
9016	PORTA CADEADO 5"
9015	PORTA CADEADO 3"

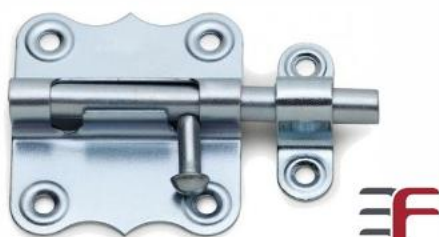

CÓD.	DESCRIÇÃO
6890	TARJETA FIO REDONDO 1 1/2"
6891	TARJETA FIO REDONDO 2 "
6892	TARJETA FIO REDONDO 2 1/2"
6893	TARJETA FIO REDONDO 3 "



BOMVINK

CÓD.	DESCRIÇÃO
8458	TRINCO FERROLHO REDONDO 3" DE AÇO



BOMVINK

CÓD.	DESCRIÇÃO
8459	TRINCO FERROLHO REDONDO 4" DE AÇO



Silvana

CÓD.	DESCRIÇÃO
4578	TARJETA ZINCADA 1.1/2 FZ (38MM)-C(01)P
45794580	TARJETA ZINCADA 2 FZ (51MM)-C (01) PC
45804581	TARJETA ZINCADA 2.1/2 FZ (63MM)-C(01)P
45815897	TARJETA ZINCADA 3 FZ (76MM)-C (01) PC
58975898	TARJETA 2 ZINCADA SILVANA
58985899	TARJETA 2.1/2 ZINCADA SILVANA
5899	TARJETA 3 ZINCADA SILVANA



BOMVINK

CÓD.	DESCRIÇÃO
8457	TRINCO FERROLHO CHATO 3" DE AÇO



Silvana

CÓD.	DESCRIÇÃO
6092	DOBRADICA PIVOTANTE 885 CROMADA CARTELA

FERRAGENS



Bestfer

CÓD.	DESCRIÇÃO
7364	ABRACADEIRA BORBOLETA 1 RSF
7363	ABRACADEIRA BORBOLETA 1/2 RSF
7365	ABRACADEIRA BORBOLETA 3/4 RSF
7366	ABRACADEIRA BORBOLETA 5/8 RSF



BOMVINK

CÓD.	DESCRIÇÃO
8113	PUXADOR KIT COM 2 UNIDADES 4"



São Raphael
Metalurgia

CÓD.	DESCRIÇÃO
2126	PUXADOR ALÇA DE CHAPA Nº 1 BTO
2127	PUXADOR ALÇA DE CHAPA Nº 2 BTO



Bestfer

CÓD.	DESCRIÇÃO
7553	PUXADOR KIT COM 2 UNIDADES



INCA

CÓD.	DESCRIÇÃO
2930	ABR ZIN TIP D C/ CUN 1/2
29312932	ABR ZIN TIP D C/ CUN 3/4
29322933	ABR ZIN TIP D C/ CUN 1
29332934	ABR ZIN TIP D C/ CUN 1.1/4
29342935	ABR ZIN TIP D C/ CUN 1.1/2
29352936	ABR ZIN TIP D C/ CUN 2
29362937	ABR ZIN TIP D C/ CUN 2.1/2
29372938	ABR ZIN TIP D C/ CUN 3
29382939	ABR ZIN TIP D C/ CUN 3.1/2
2939	ABR ZIN TIP D C/ CUN 4



INCA

CÓD.	DESCRIÇÃO
2941	ABR ZIN TIP U 1/2
29422940	ABR ZIN TIP U 3/4
29402943	ABR ZIN TIP U 1
29432945	ABR ZIN TIP U 1.1/2
29452944	ABR ZIN TIP U 1.1/4
29442946	ABR ZIN TIP U 1.1/2
29462947	ABR ZIN TIP U 2
29472948	ABR ZIN TIP U 2.1/2
29482949	ABR ZIN TIP U 3
29492950	ABR ZIN TIP U 3.1/2
2950	ABR ZIN TIP U 4



Bestfer

CÓD.	DESCRIÇÃO
7544	ABRACADEIRA RSF 1/2 POL INOX
7545	ABRACADEIRA RSF 3/4 POL INOX
7546	ABRACADEIRA RSF 1 POL INOX
7547	ABRACADEIRA RSF 1.1/2 POL INOX



INCA

CÓD.	DESCRIÇÃO
2914	ABR RSFM 1/2 X 3/4" 9 MM (13 X 19)
29132917	ABR RSFM 1/2 X 5/8" 9 MM (13 X 16)
29172911	ABR RSFM 3/4 X 1 9 MM (19 X 25)
2911	ABR RSFM 5/16 X 3/8" 9 MM (8 X 10)



INCA

CÓD.	DESCRIÇÃO
2918	ABR RSF 7/8 X 1.1/4" 9 MM (22 X 32)
29192921	ABR RSF 1 X 1.1/2" 9 MM (25 X 38)
29212922	ABR RSF 1.1/2 X 2" 9 MM (38 X 51)
29222923	ABR RSF 1.3/4 X 2.1/4" 9 MM (44 X 57)
29232925	ABR RSF 2 X 2.1/2" 9 MM (51 X 64)
29252924	ABR RSF 2.1/2 X 3 9 MM (64 X 76)
29242927	ABR RSF 2.1/4 X 2.3/4" 9 MM (57 X 70)
29272928	ABR RSF 3 X 3.1/2" 9 MM (76 X 89)
29282929	ABR RSF 3.1/4 X 3.3/4" 9 MM (83 X 95)
2929	ABR RSF 3.1/2 X 4" 9 MM (89 X 101)



BOMVINK

CÓD.	DESCRIÇÃO
8577	JOGO DE ABRACADEIRAS RSF (8 PEÇAS)



prismabec

CÓD.	DESCRIÇÃO
7705	ABRACADEIRA PARA LÂMPADA TUBULAR T8



Bestfer

CÓD.	DESCRIÇÃO
7698	RODÍZIO GIRATÓRIO TRANSPARENTE 2 POL
7699	RODÍZIO GIRATÓRIO TRANSPARENTE 3 POL



Bestfer

CÓD.	DESCRIÇÃO
7700	RODÍZIO GIRATÓRIO PRETO COM FREIO 2 POL
7702	RODÍZIO GIRATÓRIO PRETO COM FREIO 3 POL



Bestfer

CÓD.	DESCRIÇÃO
7696	RODÍZIO GIRATÓRIO TRANSPARENTE C/FREIO 2 POL
7697	RODÍZIO GIRATÓRIO TRANSPARENTE C/FREIO 3 POL



Bestfer

CÓD.	DESCRIÇÃO
7701	RODÍZIO GIRATÓRIO PRETO 2 POL
7703	RODÍZIO GIRATÓRIO PRETO 3 POL

FERRAGENS



ALUREM

CÓD.	DESCRIÇÃO
2641	FRISO VEDANTE P/ PORTA 80CM
2642	FRISO VEDANTE P/ PORTA 90CM



PADO

CÓD.	DESCRIÇÃO
4907	CADEADO HASTE LONGA LT-35/50MM
5367	CADEADO HASTE LONGA LT-45/75MM



F

CÓD.	DESCRIÇÃO
6493	CADEADO 25MM SEGREDO ENCARTELADO
6494	CADEADO 40MM SEGREDO ENCARTELADO

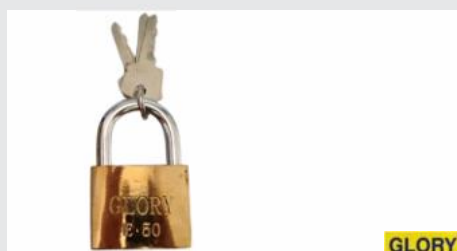

GLORY

CÓD.	DESCRIÇÃO
1522	CADEADO 20MM GLORY
1523	CADEADO 25MM GLORY
1524	CADEADO 32MM GLORY
3783	CADEADO 38MM GLORY
1525	CADEADO 50MM GLORY



PAPAIZ

CÓD.	DESCRIÇÃO
7246	CADEADO HASTE LONGA LT-35/50MM PAPAIZ
7247	CADEADO HASTE LONGA LT-45/75MM PAPAIZ



F

CÓD.	DESCRIÇÃO
6456	CADEADO 20MM 3F
6461	CADEADO 25MM 3F
6462	CADEADO 30MM 3F
6463	CADEADO 35MM 3F
6464	CADEADO 45MM 3F



PADO

CÓD.	DESCRIÇÃO
3863	CADEADO 20MM
3864	CADEADO 25MM
3865	CADEADO 30MM
3866	CADEADO 35MM
3867	CADEADO 40MM
3868	CADEADO 45MM
3869	CADEADO 50MM
3870	CADEADO 60MM



PAPAIZ

CÓD.	DESCRIÇÃO
5872	CADEADO 20MM PAPAIZ
5873	CADEADO 25MM PAPAIZ
5874	CADEADO 30MM PAPAIZ
5875	CADEADO 35MM PAPAIZ
5876	CADEADO 40MM PAPAIZ
5877	CADEADO 45MM PAPAIZ
5878	CADEADO 50MM PAPAIZ
5879	CADEADO 60MM PAPAIZ
5880	CADEADO 70MM PAPAIZ

AUTOMOTIVA

ULTRA
ATACADISTA

THOMPSON

**NOVIDADES QUE
FAZEM A DIFERENÇA!**

1
ANO
GARANTIA

Chegaram os **lançamentos** que vão transformar sua rotina de trabalho. Mais tecnologia, mais precisão e a durabilidade que você já conhece. Prepare-se para elevar o seu desempenho!

Confira agora a nova linha de ferramentas.

NOVO



- CABO PARA TRANSFERÊNCIA DE CARGA
- PULVERIZADOR MANUAL
- CHAVE SOQUETE 3/8" - 11 PEÇAS
- CHAVE DE RODA CRUZETA
- CHAVE SOQUETE 1/4" - 40 PEÇAS
- FITA SILVER REFORÇADA
- ALICATE BOMBA D'ÁGUA

AUTOMOTIVA



CÓD. DESCRIÇÃO
3988 SILICONE SPRAY 300 ML INCOLOR



CÓD. DESCRIÇÃO
5705 SILICONE SELANTE P/ MOTOR PRETO 50G



CÓD. DESCRIÇÃO
5703 DESCARBONIZANTE 300ML/209G CAR 2000



CÓD. DESCRIÇÃO
5696 DESENGRIPANTE SPRAY WHITE LUB 300ML/209G



CÓD. DESCRIÇÃO
5647 DESENGRIPANTE SPRAY 300ML WD40



CÓD. DESCRIÇÃO
3987 LIMPA CONTATO SPRAY 300ML



CÓD. DESCRIÇÃO
5702 LIMPA CONTATOS 300ML/209G



CÓD. DESCRIÇÃO
5530 GRAFITE SPRAY SECO 200ML/100G



CÓD. DESCRIÇÃO
5531 GRAXA BRANCA SPRAY 200G/300ML



CÓD. DESCRIÇÃO
7737 DESENGRAXANTE H7 SPRAY MULTIUSO 1 LITRO
7841 DESENGRAXANTE H7 SPRAY MULTIUSO 500 ML



CÓD. DESCRIÇÃO
7736 DESENGRAXANTE H7 REFIL MULTIUSO 1 LITRO
7738 DESENGRAXANTE H7 REFIL MULTIUSO 500 ML



CÓD. DESCRIÇÃO
8849 DESENGRAXANTE MULTIUSO MD7 - 1 L
8848 DESENGRAXANTE MULTIUSO MD7 - 500ML



CÓD. DESCRIÇÃO
4127 REMOVEDOR PASTOSO AUTOMOTIVO 225 ML
4128 REMOVEDOR PASTOSO AUTOMOTIVO 900 ML















CÓD. DESCRIÇÃO
5698 ADITIVO PROTETIVO ROSA P/ RADIADORES 1L

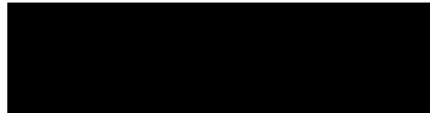

CÓD. DESCRIÇÃO
5699 LIMPA AR CONDICIONADO CARRO NOVO 200ML

AUTOMOTIVA

 <p>3M</p>	 <p>ORBI QUÍMICA</p>	 <p>Nova</p>
<p>CÓD. DESCRIÇÃO</p> <p>4447 FITA DUPLA FACE 12MM X 3M AUTOMOTIVA</p>	<p>CÓD. DESCRIÇÃO</p> <p>5701 ADESIVO TRAVA PARAFUSO ORBIFIX 10 VERMELHO</p>	<p>CÓD. DESCRIÇÃO</p> <p>6221 ÓLEO LUBRIFICANTE MULTIUSO 100ML NOVA</p>
 <p>S SINGER</p>	 <p>BOMVINK</p>	 <p>THOMPSON</p>
<p>CÓD. DESCRIÇÃO</p> <p>7863 ÓLEO SINGER 100ML</p>	<p>CÓD. DESCRIÇÃO</p> <p>8337 COMPRESSOR DE AR PORTATIL</p>	<p>CÓD. DESCRIÇÃO</p> <p>3323 BOMBA DE AR PEDAL</p>
 <p>Bestfer</p>	 <p>BOMVINK</p>	 <p>ULTRA</p>
<p>CÓD. DESCRIÇÃO</p> <p>7549 FERRO DE SOLDAR 30W 127V 7550 FERRO DE SOLDAR 60W 127V 7551 FERRO DE SOLDAR 90W 127V</p>	<p>CÓD. DESCRIÇÃO</p> <p>8269 MÁSCARA DE SOLDA COM VISOR</p>	<p>CÓD. DESCRIÇÃO</p> <p>7598 ELETRODO 6013 2,50MM X 350MM C/ 5KG 7599 ELETRODO 6013 3,25MM X 350MM C/ 5KG</p>
 <p>STAR</p>	 <p>STAR</p>	 <p>THOMPSON</p>
<p>CÓD. DESCRIÇÃO</p> <p>6532 ELETRODO 7018 2,50MM 65 A 100 AMP. LT C/17 KG</p>	<p>CÓD. DESCRIÇÃO</p> <p>8969 ELETRODO STAR 6013 2,50 X 350 C/ 5KG 8970 ELETRODO STAR 6013 3,25 X 350 C/ 5KG</p>	<p>CÓD. DESCRIÇÃO</p> <p>8554 ELETRODO 6013 3,25MM CINZA 5KG 8553 ELETRODO 6013 2,50MM CINZA 5KG</p>
 <p>THOMPSON</p>	<p>500AMP</p>  <p>BOMVINK</p>	 <p>AM METAIS</p>
<p>CÓD. DESCRIÇÃO</p> <p>2374 PORTA ELETRODO 300A 2375 PORTA ELETRODO 500A</p>	<p>CÓD. DESCRIÇÃO</p> <p>8308 CABO DE BATERIA PARA CARRO 500 AMP</p>	<p>CÓD. DESCRIÇÃO</p> <p>6393 CABO DE BATERIA 2,4 METROS</p>



CÓD. DESCRIÇÃO
1542 CABO DE BATERIA 400 AMP 2,50M



CÓD. DESCRIÇÃO
8089 CABO DE BATERIA 2,5M 200A LCTO
8090 CABO DE BATERIA 2,5M 300A LCTO



CÓD. DESCRIÇÃO
7634 GARRA JACARÉ 20A 2 PEÇAS
7635 GARRA JACARÉ 30A 2 PEÇAS
7636 GARRA JACARÉ 50A 2 PEÇAS



CÓD. DESCRIÇÃO
7125 MASSA PLÁSTICA 400G CINZA



CÓD. DESCRIÇÃO
7849 MASSA PLÁSTICA BRANCA 400GR
7850 MASSA PLÁSTICA CINZA 400GR
7851 MASSA PLÁSTICA PRETA 400GR



CÓD. DESCRIÇÃO
4089 MASSA PLÁSTICA 400G CINZA



CÓD. DESCRIÇÃO
4127 REMOVEDOR PASTOSO AUTOMOTIVO 225 ML
4128 REMOVEDOR PASTOSO AUTOMOTIVO 900 ML



CÓD. DESCRIÇÃO
7853 CATALISADOR MASSA PLÁSTICA 12 GR



CÓD. DESCRIÇÃO
6227 REMOVEDOR DE FERRUGEM LÍQUIDO 500ML



CÓD. DESCRIÇÃO
7838 CONVERTEDOR FERRUGEM BASE PINTURA 1L
7839 CONVERTEDOR FERRUGEM BASE PINTURA 200ML
7840 CONVERTEDOR FERRUGEM BASE PINTURA 500ML



CÓD. DESCRIÇÃO
4968 BOINA PARA POLIMENTO N 05" LA CARNEIRO
4972 BOINA PARA POLIMENTO N 08" LA CARNEIRO



CÓD. DESCRIÇÃO
8866 MACACO HIDRAULICO 6T TIPO GARRAFA

FIXADORES

ULTRA
/// ATACADISTA

ULTRA

**7006 - GANCHO
PARA REDE COM
CHUMBADOR**



**7014 - GANCHO
PARA REDE PARA
PARAFUSAR**

RES

FIXADORES



prismatec

CÓD.	DESCRIÇÃO
7169	BUCHA NYLON 06 (PCT 1000 UN.)
7170	BUCHA NYLON 08 (PCT 1000 UN.)
7171	BUCHA NYLON 10 (PCT 500 UN.)
7172	BUCHA NYLON 12 (PCT 300 UN.)



prismatec

CÓD.	DESCRIÇÃO
7173	BUCHA NYLON 06 C/ANEL (PCT 1000 UN.)
7174	BUCHA NYLON 08 C/ANEL (PCT 1000 UN.)
7175	BUCHA NYLON 10 C/ANEL (PCT 500 UN.)
7176	BUCHA NYLON 12 C/ANEL (PCT 300 UN.)



BelTools

CÓD.	DESCRIÇÃO
3273	BUCHA NYLON 06 C/ANEL
32753278	BUCHA NYLON 08 C/ANEL
32783279	BUCHA NYLON 10 C/ANEL
3279	BUCHA NYLON 12 C/ANEL



BelTools

CÓD.	DESCRIÇÃO
3280	BUCHA TJ BAIANO 06
32823283	BUCHA TJ BAIANO 08
32833284	BUCHA TJ BAIANO 10
3284	BUCHA TJ BAIANO 12



BOMVINK

CÓD.	DESCRIÇÃO
8359	KIT PARAFUSOS COM BUCHA 06 (CARTELA 20)



BOMVINK

CÓD.	DESCRIÇÃO
8360	KIT PARAFUSOS COM BUCHA 08 (CARTELA COM 20)



BOMVINK

CÓD.	DESCRIÇÃO
8361	KIT PARAFUSOS COM BUCHA 10 (CARTELA COM 20)



BOMVINK

CÓD.	DESCRIÇÃO
8362	KIT PARAFUSOS COM BUCHA 10 (CARTELA COM 20)



Sio Raphael

CÓD.	DESCRIÇÃO
2132	GANCHO ROS. P/ MADEIRA 14X30 BTO
21332134	GANCHO ROS. P/ MADEIRA 16X30 BTO
21342135	GANCHO ROS. P/ MADEIRA 17X40 BTO
21353425	GANCHO ROS. P/ MADEIRA 17X50 BTO
34253426	GANCHO ROS. P/ MADEIRA 17X60 BTO
34263427	GANCHO ROS. P/ MADEIRA 18X70 BTO
34273428	GANCHO ROS. P/ MADEIRA 19X80 BTO
34283429	GANCHO ROS. P/ MADEIRA 21X90 BTO
3429	GANCHO ROS. P/ MADEIRA 22X100 BTO



JOMARCA

CÓD.	DESCRIÇÃO
3430	PITAO ROSCA P/MADEIRA 15 X 30 BTO
34312130	PITAO ROSCA P/MADEIRA 16 X 30 BTO
21302131	PITAO ROSCA P/MADEIRA 18 X 45 BTO
2131	PITAO ROSCA P/MADEIRA 19 X 50 BTO



JOMARCA

CÓD.	DESCRIÇÃO
2147	PITÃO C/ ROSCA C/ BUCHA B-05 BTO
21482149	PITÃO C/ ROSCA C/ BUCHA B-06 BTO
21492150	PITÃO C/ ROSCA C/ BUCHA B-08 BTO
21502151	PITÃO C/ ROSCA C/ BUCHA B-10 BTO
2151	PITÃO C/ ROSCA C/ BUCHA B-12 BTO



JOMARCA

CÓD.	DESCRIÇÃO
2142	GANCHO ROSCA C/ BUCHA B-05 BTO
21432144	GANCHO ROSCA C/ BUCHA B-06 BTO
21442145	GANCHO ROSCA C/ BUCHA B-08 BTO
21452146	GANCHO ROSCA C/ BUCHA B-10 BTO
2146	GANCHO ROSCA C/ BUCHA B-12 BTO



Silvana

CÓD.	DESCRIÇÃO
5883	GANCHO P/REDE C/CHUMBADOR SILVANA
5884	GANCHO P/REDE P/PARAFUSAR SILVANA



URSICH

CÓD.	DESCRIÇÃO
2123	GANCHO P/REDE P/PARAFUSAR



URSICH

CÓD.	DESCRIÇÃO
2124	GANCHO P/REDE C/CHUMBADOR

FIXADORES



CÓD. 4583 DESCRIÇÃO GANCHO P/REDE C/CHUMBADOR



CÓD. 7014 DESCRIÇÃO GANCHO PARA REDE PARA PARAFUSAR



CÓD. 7006 DESCRIÇÃO GANCHO PARA REDE COM CHUMBADOR



CÓD. 2152 DESCRIÇÃO ESCÁPULA ROSCA C/ BUCHA B-05 BTO
21532154 ESCÁPULA ROSCA C/ BUCHA B-06 BTO
21542155 ESCÁPULA ROSCA C/ BUCHA B-08 BTO
2155 ESCÁPULA ROSCA C/ BUCHA B-10 BTO



CÓD. 2136 DESCRIÇÃO ESCÁP. ROSCA P/ MADEIRA 16X30 BTO
21372138 ESCÁP. ROSCA P/ MADEIRA 17X50 BTO
21382139 ESCÁP. ROSCA P/ MADEIRA 19X60 BTO
2139 ESCÁP. ROSCA P/ MADEIRA 21X70 BTO



CÓD. 1331 DESCRIÇÃO GRAMPO MIGUELAO BRANCO RIBEIRO
1332 GRAMPO MIGUELAO MARROM RIBEIRO



CÓD. 7625 DESCRIÇÃO GRAMPO MIGUELÃO BRANCO



CÓD. 5371 DESCRIÇÃO PF BROCANTE FLANGEADA DRILL P/B 4,2X16
5351 PF BROCANTE FLANGEADA DRILL P/B 4,2X19
5372 PF BROCANTE FLANGEADA DRILL P/B 4,2X25



CÓD. 5373 DESCRIÇÃO PF BROCANTE TROMBETA P/B 3,5X25MM DRYWALL
5352 PF BROCANTE TROMBETA P/B 3,5X35MM DRYWALL



CÓD. 5353 DESCRIÇÃO PF BROCANTE P/A 4,2X13MM DRYWAL FLANGEADO
6958 PF BROCANTE P/A 4,2X19MM DRYWAL FLANGEADO



CÓD. 5348 DESCRIÇÃO PF BROCANTE SEXTAVADO P/B C/ARRUELA 12X3/4
53495388 BROCANTE SEXTAVADO P/B C/ARRUELA 12X1
53685388 BROCANTE SEXTAVADO P/B C/ARRUELA 14X3/4
5369 PF BROCANTE SEXTAVADO P/B C/ARRUELA 14X1



CÓD. 2952 DESCRIÇÃO PF FIXACAO VASO SANITARIO B10
2953 PF FIXACAO VASO SANITARIO B12



CÓD. 2475 DESCRIÇÃO PF FIXAÇÃO VASO SANITARIO B08



CÓD. 4880 DESCRIÇÃO PARAFUSO LATÃO 5/32 X 50MM



CÓD. 1447 DESCRIÇÃO PARAFUSO ASSENTO BRANCO (PAR)

FIXADORES



CÓD.	DESCRIÇÃO
3021	REBITE REPUXO J-208 2 4X8 MM ZI
30203250	REBITE REPUXO J-308 3 2X8 MM ZI
32503023	REBITE REPUXO J-312 3 2X12 MM ZI
30233024	REBITE REPUXO J-316 3 2X16 MM ZI
30243025	REBITE REPUXO J-322 3 2X22 MM ZI
30255235	REBITE REPUXO J-325 3 2X25 MM ZI
52353026	REBITE REPUXO J-406 4 0X06MM ZI
30263027	REBITE REPUXO J-410 4 0X10 MM ZI
30273028	REBITE REPUXO J-412 4 0X12 MM ZI
30283029	REBITE REPUXO J-416 4 0X16 MM ZI
3029	REBITE REPUXO J-422 4 0X22 MM ZI

CÓD.	DESCRIÇÃO
3030	REBITE REPUXO J-425 4 0X25 MM ZI
30313032	REBITE REPUXO J-510 4 8X10 MM ZI
30323033	REBITE REPUXO J-512 4 8X12 MM ZI
30333034	REBITE REPUXO J-516 4 8X16 MM ZI
30343035	REBITE REPUXO J-522 4 8X22 MM ZI
30353036	REBITE REPUXO J-525 4 8X25 MM ZI
30363037	REBITE REPUXO J-535 4 8X35MM ZI
30373038	REBITE REPUXO J-612 6 2X12 MM ZI
30383039	REBITE REPUXO J-616 6 2X16 MM ZI
30393040	REBITE REPUXO J-622 6 2X22 MM ZI
30403041	REBITE REPUXO J-625 6 2X25 MM ZI
3041	REBITE REPUXO J-635 6 2X35 MM ZI



CÓD.	DESCRIÇÃO
8460	REBITE DE REPUXO 4* 12MM (COM 20 PEÇAS)



CÓD.	DESCRIÇÃO
8008	PREGO GERDAU 10X10 C/C POLIDO 1KG
7360	PREGO GERDAU 12X12 C/C POLIDO 1KG
7921	PREGO GERDAU 15X15 C/C POLIDO 1KG
7330	PREGO GERDAU 25X72 C/C POLIDO 1KG
7289	PREGO GERDAU 15X21 C/C POLIDO 1KG
7288	PREGO GERDAU 22X48 C/C POLIDO 1KG
7688	PREGO GERDAU 20X30 C/C POLIDO 1KG
7269	PREGO GERDAU 18X30 C/C POLIDO 1KG

CÓD.	DESCRIÇÃO
7266	PREGO GERDAU 18X36 C/C POLIDO 1KG
7265	PREGO GERDAU 17X27 C/C POLIDO 1KG
7264	PREGO GERDAU 17X21 C/C POLIDO 1KG
8012	PREGO GERDAU 20X42 C/C POLIDO 1KG
7263	PREGO GERDAU 20X48 C/C POLIDO 1KG
7262	PREGO GERDAU 16X24 C/C POLIDO 1KG
7261	PREGO GERDAU 18X27 C/C POLIDO 1KG
7259	PREGO GERDAU 18X24 C/C POLIDO 1KG
7296	PREGO GERDAU 19X36 C/C POLIDO 1KG



CÓD.	DESCRIÇÃO
8009	PREGO GERDAU SEM CABEÇA 10X10 POLIDO 1KG
8010	PREGO GERDAU SEM CABEÇA 12X12 POLIDO 1KG



CÓD.	DESCRIÇÃO
7260	PREGO CABECA DUPLA 18X30 POLIDO 1 KG



CÓD.	DESCRIÇÃO
6953	PREGO POLIDO 12X21 C/C TORALF 1KG
59096950	PREGO POLIDO 15X15 C/C TORALF 1KG
69506952	PREGO POLIDO 15X21 C/C TORALF 1KG
69525910	PREGO POLIDO 16X24 C/C TORALF 1KG
59105911	PREGO POLIDO 17X21 C/C TORALF 1KG
59115912	PREGO POLIDO 17X27 C/C TORALF 1KG
59125913	PREGO POLIDO 18X24 C/C TORALF 1KG
59135914	PREGO POLIDO 18X27 C/C TORALF 1KG
59146951	PREGO POLIDO 18X30 C/C TORALF 1KG
69515915	PREGO POLIDO 18X36 C/C TORALF 1KG
5915	PREGO POLIDO 19X36 C/C TORALF 1KG



CÓD.	DESCRIÇÃO
7292	GRAMPO P/ CERCA 1X9 POLIDO GERDAU



CÓD.	DESCRIÇÃO
6801	PF TELHEIRO C/ KIT VEDACAO 110MM ZI CX 100



CÓD.	DESCRIÇÃO
7242	PREGO TELHEIRO 18X36 KIT FIXADOR 4MM
7243	PREGO TELHEIRO 18X36 KIT FIXADOR
7285	PREGO TELHEIRO 20X42 C/20 PREGOS



CÓD.	DESCRIÇÃO
2466	PF TELHEIRO C/ KIT VEDACAO 110MM ZI 100 UND.



CÓD.	DESCRIÇÃO
2479	BARRA ROSCA AÇO 1/4 X 1000 MM ZINCADA
24832484	BARRA ROSCA AÇO 1/2 X 1000 MM ZINCADA
24842481	BARRA ROSCA AÇO 3/4 X 1000 MM ZINCADA
24812478	BARRA ROSCA AÇO 3/8 X 1000 MM ZINCADA
24782848	BARRA ROSCA AÇO 3/16 X 1000 MM ZINCADA
28482480	BARRA ROSCA AÇO 5/8 X 1000MM ZINCADA
24802477	BARRA ROSCA AÇO 5/16 X 1000 MM ZINCADA
24772482	BARRA ROSCA AÇO 5/32 X 1000 MM ZINCADA
2482	BARRA ROSCA AÇO 7/16 X 1000 MM ZINCADA



CÓD.	DESCRIÇÃO
2469	PORCA UNC SEXTAVADA 1/4 ZC
34172548	PORCA UNC SEXTAVADA 1/2 ZC
25482574	PORCA UNC SEXTAVADA 3/4 ZC
25742547	PORCA UNC SEXTAVADA 1/8 ZC
25472468	PORCA UNC SEXTAVADA 3/8 ZC
24683256	PORCA UNC SEXTAVADA 3/16 ZC
32562546	PORCA UNC SEXTAVADA 5/8 ZC
25462467	PORCA UNC SEXTAVADA 5/16 ZC
2467	PORCA UNC SEXTAVADA 5/32 ZC

FIXADORES



CÓD.	DESCRIÇÃO
2729	PF CHIPBOARD PHS 2,5 X 10 MM CAB. CT BIC.
2730	PF CHIPBOARD PHS 2,5 X 12 MM CAB. CT BIC.
2731	PF CHIPBOARD PHS 2,5 X 14 MM CAB. CT BIC.
2732	PF CHIPBOARD PHS 2,5 X 16 MM CAB. CT BIC.
2733	PF CHIPBOARD PHS 3,0 X 10 MM CAB. CT BIC.
3770	PF CHIPBOARD PHS 3,0 X 12 MM CAB. CT BIC.
2789	PF CHIPBOARD PHS 3,0 X 14 MM CAB. CT BIC.
2735	PF CHIPBOARD PHS 3,0 X 16 MM CAB. CT BIC.
2736	PF CHIPBOARD PHS 3,0 X 20 MM CAB. CT BIC.
2422	PF CHIPBOARD PHS 3,0 X 22MM CAB. CT BIC.
2737	PF CHIPBOARD PHS 3,0 X 25 MM CAB. CT BIC.
4356	PF CHIPBOARD PHS 3,0 X 30 MM CAB. CT BIC.
3407	PF CHIPBOARD PHS 3,5 X 10 MM CAB. CT BIC.
2739	PF CHIPBOARD PHS 3,5 X 12 MM CAB. CT BIC.
2740	PF CHIPBOARD PHS 3,5 X 14 MM CAB. CT BIC.
2423	PF CHIPBOARD PHS 3,5 X 16 MM CAB. CT BIC.
4527	PF CHIPBOARD PHS 3,5 X 20 MM CAB. CT BIC.
2682	PF CHIPBOARD PHS 3,5 X 22 MM CAB. CT BIC.
2742	PF CHIPBOARD PHS 3,5 X 25 MM CAB. CT BIC.
2425	PF CHIPBOARD PHS 3,5 X 30 MM CAB. CT BIC.
2791	PF CHIPBOARD PHS 3,5 X 35 MM CAB. CT BIC.
2427	PF CHIPBOARD PHS 3,5 X 40 MM CAB. CT BIC.
2657	PF CHIPBOARD PHS 4,0 X 12 MM CAB. CT BIC.
2658	PF CHIPBOARD PHS 4,0 X 14 MM CAB. CT BIC.
3408	PF CHIPBOARD PHS 4,0 X 16 MM CAB. CT BIC.
2659	PF CHIPBOARD PHS 4,0 X 20 MM CAB. CT BIC.
2660	PF CHIPBOARD PHS 4,0 X 22 MM CAB. CT BIC.
2428	PF CHIPBOARD PHS 4,0 X 25 MM CAB. CT BIC.
2792	PF CHIPBOARD PHS 4,0 X 30 MM CAB. CT BIC.
2430	PF CHIPBOARD PHS 4,0 X 35 MM CAB. CT BIC.
2431	PF CHIPBOARD PHS 4,0 X 40 MM CAB. CT BIC.
5433	PF CHIPBOARD PHS 4,0 X 45 MM CAB. CT BIC.
2433	PF CHIPBOARD PHS 4,0 X 50 MM CAB. CT BIC.
2661	PF CHIPBOARD PHS 4,5 X 16 MM CAB. CT BIC.
2662	PF CHIPBOARD PHS 4,5 X 20 MM CAB. CT BIC.
2663	PF CHIPBOARD PHS 4,5 X 22 MM CAB. CT BIC.
2664	PF CHIPBOARD PHS 4,5 X 25 MM CAB. CT BIC.
2665	PF CHIPBOARD PHS 4,5 X 60 MM CAB. CT BIC.
2666	PF CHIPBOARD PHS 5,0 X 25 MM CAB. CT BIC.
2667	PF CHIPBOARD PHS 5,0 X 40 MM CAB. CT BIC.
2668	PF CHIPBOARD PHS 5,0 X 45 MM CAB. CT BIC.
2670	PF CHIPBOARD PHS 5,0 X 65 MM CAB. CT BIC.
2671	PF CHIPBOARD PHS 5,0 X 70 MM CAB. CT BIC.
2672	PF CHIPBOARD PHS 5,0 X 80 MM CAB. CT BIC.
2673	PF CHIPBOARD PHS 5,0 X 90 MM CAB. CT BIC.
2674	PF CHIPBOARD PHS 6,0 X 25 MM CAB. CT BIC.
4335	PF CHIPBOARD PHS 6,0 X 30 MM CAB. CT BIC.
2676	PF CHIPBOARD PHS 6,0 X 35 MM CAB. CT BIC.
3410	PF CHIPBOARD PHS 6,0 X 40 MM CAB. CT BIC.
2441	PF CHIPBOARD PHS 6,0 X 45 MM CAB. CT BIC.
3411	PF CHIPBOARD PHS 6,0 X 50 MM CAB. CT BIC.
2442	PF CHIPBOARD PHS 6,0 X 60 MM CAB. CT BIC.
3889	PF CHIPBOARD PHS 6,0 X 65 MM CAB. CT BIC.
2679	PF CHIPBOARD PHS 6,0 X 70 MM CAB. CT BIC.
2680	PF CHIPBOARD PHS 6,0 X 80 MM CAB. CT BIC.
2681	PF CHIPBOARD PHS 6,0 X 90 MM CAB. CT BIC.
3412	PF CHIPBOARD PHS 6,0 X 100 MM CAB. CT BIC.



CÓD.	DESCRIÇÃO
2743	PF FRANCÊS C/PORCA 3/16 X 1 BSW ZC
2744	PF FRANCÊS C/POR. 3/16 X 1.1/2 BSWZC
2518	PF FRANCÊS C/PORCA 3/16 X 2 ZC
2519	PF FRANCÊS C/ PORCA 3/16 X 2.1/4 ZC
2520	PF FRANCÊS C/ PORCA 3/16 X 2.1/2 ZC
2446	PF FRANCÊS C/ PORCA 3/16 X 3 ZC
2521	PF FRANCÊS C/ PORCA 1/4 X 1 ZC
2766	PF FRANCÊS C/PORCA 1/4 X 1.1/4 BSW ZC
2522	PF FRANCÊS C/ PORCA 1/4 X 1.1/2 ZC
2747	PF FRANCÊS C/PORCA 1/4 X 1.3/4 BSW ZC
2690	PF FRANCÊS C/PORCA 1/4 X2 ZC
2445	PF FRANCÊS C/ PORCA 1/4 X 2.1/2 ZC
2446	PF FRANCÊS C/ PORCA 1/4 X 3 ZC
3249	PF FRANCÊS C/PORCA 1/4 X 3.1/2 BSW ZC
2447	PF FRANCÊS C/ PORCA 1/4 X4 ZC
2749	PF FRANCÊS C/PORCA 1/4 X 4.1/2 BSW ZC
2448	PF FRANCÊS C/ PORCA 1/4 X 5 ZC
2750	PF FRANCÊS C/PORCA 5/16 X 3/4 BSW ZC
2449	PF FRANCÊS C/PORCA 5/16X1 ZINCADO
2745	PF FRANCÊS C/PORCA 5/16X1.1/4 BSW ZINCADO
2751	PF FRANCÊS C/POR. 5/16 X1.1/2 BSW ZC
2450	PF FRANCÊS C/PORCA 5/16X2 ZINCADO
2451	PF FRANCÊS C/PORCA 5/16X2.1/2 ZINCADO
4614	PF FRANCÊS C/PORCA 5/16X3 ZINCADO
2453	PF FRANCÊS C/PORCA 5/16X3.1/2 ZINCADO
2454	PF FRANCÊS C/PORCA 5/16X4 BSW ZINCADO
4316	PF FRANCÊS C/PORCA 5/16 X 5 ZC
2752	PF FRANCÊS C/POR. 5/16 X 5.1/2 BSW ZC
2566	PF FRANCÊS C/PORCA 5/16 X 6 BSW ZC
2753	PF FRANCÊS C/POR. 5/16 X 6.1/2 BSW ZC
4893	PF FRANCÊS C/PORCA 5/16X7 BSW ZINCADO
2573	PF FRANCÊS C/PORCA 5/16 X 8 ZC
2754	PF FRANCÊS C/PORCA 3/8 X 1 BSW ZC
2523	PF FRANCÊS C/ PORCA 3/8 X 1.1/2 ZC
2524	PF FRANCÊS C/ PORCA 3/8 X 2 ZC
2525	PF FRANCÊS C/ PORCA 3/8 X 2.1/2 ZC
2526	PF FRANCÊS C/ PORCA 3/8 X 3 ZC
2755	PF FRANCÊS C/PORC 3/8 X 3.1/2 BSW ZC
2567	PF FRANCÊS C/PORCA 3/8 X 4 MQ UNC ZC
2756	PF FRANCÊS C/PORC 3/8 X 4.1/2 BSW ZC
2568	PF FRANCÊS C/ PORCA 3/8 X 5 ZC
2757	PF FRANCÊS C/PORC 3/8 X 5.1/2 BSW ZC
2569	PF FRANCÊS C/ PORCA 3/8 X 6 ZC
2758	PF FRANCÊS C/PORC 3/8 X 6.1/2 BSW ZC
4754	PF FRANCÊS C/PORCA 3/8X7 ZINCADO
4755	PF FRANCÊS C/PORCA 3/8X8 ZINCADO
2527	PF FRANCÊS C/ PORCA 1/2 X 1.1/2 BSW ZC
2568	PF FRANCÊS C/ PORCA 1/2 X 2 BSW ZC
2795	PF FRANCÊS C/POR. 1/2 X 2.1/2 BSW ZC
2576	PF FRANCÊS C/PORCA 1/2 X 3 BSW ZC
2759	PF FRANCÊS C/PORCA 1/2 X 3.1/2 BSW ZC
2577	PF FRANCÊS C/PORCA 1/2 X 4 BSW ZC
2760	PF FRANCÊS C/PORCA 1/2 X 4.1/2 BSW ZC
2578	PF FRANCÊS C/PORCA 1/2 X 5 BSW ZC
2761	PF FRANCÊS C/PORCA 1/2 X 5.1/2 BSW ZC
2796	PF FRANCÊS C/PORCA 1/2 X 6 BSW ZC
2762	PF FRANCÊS C/PORCA 1/2 X 6.1/2 BSW ZC
2580	PF FRANCÊS C/PORCA 1/2 X 7 BSW ZC
3413	PF FRANCÊS C/ PORCA 1/2 X 7.1/2 BSW ZC
2581	PF FRANCÊS C/PORCA 1/2 X 8 BSW ZC
2686	PF FRANCÊS C/PORCA 1/2X 9 BSW ZC
2687	PF FRANCÊS C/PORCA 1/2 X 10 BSW ZC
2688	PF FRANCÊS C/PORCA 1/2 X 11 BSW ZC
2689	PF FRANCÊS C/PORCA 1/2 X 12 BSW ZC



CÓD.	DESCRIÇÃO
2486	PF A/A PANELA RETA 2,2 X 9,5 MM ZINCADO
2487	PF A/A PANELA RETA 2,9 X 13 MM ZINCADO
2488	PF A/A PANELA RETA 3,5 X 16 MM ZINCADO
2489	PF A/A PANELA RETA 3,5 X 19 MM ZINCADO
2490	PF A/A PANELA RETA 3,5 X 22 MM ZINCADO
2491	PF A/A PANELA RETA 3,9 X 13 MM ZINCADO
2492	PF A/A PANELA RETA 3,9 X 16 MM ZINCADO
2493	PF A/A PANELA RETA 3,9 X 19 MM ZINCADO
2494	PF A/A PANELA RETA 3,9 X 22 MM ZINCADO
2495	PF A/A PANELA RETA 3,9 X 25 MM ZINCADO
2496	PF A/A PANELA RETA 4,2 X 13 MM ZINCADO
2497	PF A/A PANELA RETA 4,2 X 16 MM ZINCADO
2498	PF A/A PANELA RETA 4,2 X 19 MM ZINCADO
2499	PF A/A PANELA RETA 4,2 X 22 MM ZINCADO
2500	PF A/A PANELA RETA 4,2 X 25 MM ZINCADO
2501	PF A/A PANELA RETA 4,2 X 32 MM ZINCADO
2502	PF A/A PANELA RETA 4,2 X 38 MM ZINCADO
2503	PF A/A PANELA RETA 4,8 X 13 MM ZINCADO
2504	PF A/A PANELA RETA 4,8 X 19 MM ZINCADO
2505	PF A/A PANELA RETA 4,8 X 25 MM ZINCADO
2506	PF A/A PANELA RETA 4,8 X 32 MM ZINCADO
2507	PF A/A PANELA RETA 4,8 X 38 MM ZINCADO
2508	PF A/A PANELA RETA 4,8 X 45 MM ZINCADO
2509	PF A/A PANELA RETA 4,8 X 50 MM ZINCADO
2510	PF A/A PANELA RETA 5,5 X 16 MM ZINCADO
2511	PF A/A PANELA RETA 5,5 X 19 MM ZINCADO
2512	PF A/A PANELA RETA 5,5 X 25 MM ZINCADO
2513	PF A/A PANELA RETA 5,5 X 32 MM ZINCADO
2514	PF A/A PANELA RETA 5,5 X 38 MM ZINCADO
2515	PF A/A PANELA RETA 5,5 X 50 MM ZINCADO
2516	PF A/A PANELA RETA 6,3 X 19 MM ZINCADO
2517	PF A/A PANELA RETA 6,3 X 25 MM ZINCADO



CÓD.	DESCRIÇÃO
2462	PF MADEI. ROS SOBER 1/4 X 50 MM ZC
6960	PF MADEI. ROS SOBER 1/4 X 55 MM ZC
2463	PF MADEI. ROS SOBER 1/4 X 60 MM ZC
6959	PF MADEI. ROS SOBER 1/4 X 65 MM ZC
2530	PF MADEI. ROS SOBER 1/4 X 70 MM ZC
6961	PF MADEI. ROS SOBER 1/4 X 75 MM ZC
2532	PF MADEI. ROS SOBER 3/8 X 40 MM ZC
2460	PF MADEI. ROS SOBER 3/16 X 40 MM ZC
2800	PF MADEI. ROS SOBER 3/16 X 50 MM ZC
2464	PF MADEI. ROS SOBER 5/16 X 50 MM ZC
2545	PF MADEI. ROS SOBER 5/16 X 60 MM ZC
2465	PF MADEI. ROS SOBER 5/16 X 65 MM ZC
2531	PF MADEI. ROS SOBER 5/16 X 70 MM ZC
5749	PF MADEI. ROS SOBE 5/16 X 75 MM ZC



CÓD.	DESCRIÇÃO
2472	PF A/A PANELA PHS 4,2X32MM ZINCADO
2473	PF A/A PANELA PHS 4,2X38MM ZINCADO
2474	PF A/A PANELA PHS 4,8X32MM ZINCADO
4939	PF A/A PANELA PHS 4,8X32MM ZINCADO
2476	PF A/A PANELA PHS 4,2X38MM ZINCADO

FIXADORES



CÓD.	DESCRIÇÃO
2802	PF UNC SEXTAVADO RI 3/16 X 1.1/2 ZC
2534	PF UNC SEXTAVADO RI 3/16 X 2 ZC
2455	PF UNC SEXTAVADO RI 1/4 X 3/4 ZC
3415	PF UNC SEXTAVADO RI 1/4 X 1 ZC
2684	PF UNC SEXTAVADO RI 1/4 X 1.1/2 ZC
8453	PF UNC SEXTAVADO RI 1/4 X 2.1/2 ZC
2458	PF UNC SEXTAVADO RI 5/16 X 1 ZC
2535	PF UNC SEXTAVADO RI 5/16X1.1/4 ZINCADO
2459	PF UNC SEXTAVADO RI 5/16 X 2 ZC
2537	PF UNC SEXTAVADO RI 3/8 X 1 ZC
3416	PF UNC SEXTAVADO RI 3/8 X 1.1/2 ZC
2471	PF UNC SEXTAVADO RI 3/8 X 2 ZC
2538	PF UNC SEXTAVADO RI 1/2 X1 ZC
2539	PF UNC SEXTAVADO RI 1/2 X 1.1/2 ZC
2540	PF UNC SEXTAVADO RP 1/4X3 ZC
2541	PF UNC SEXTAVADO RP 5/16X2.3/4 ZC
2542	PF UNC SEXTAVADO RP 5/16X3 ZC
2543	PF UNC SEXTAVADO RP 3/8X2.1/2 ZC
2544	PF UNC SEXTAVADO RP 1/2X2.1/2 ZC



CÓD.	DESCRIÇÃO
2549	PF A/A CH RETA 2,9 X 13 MM ZINCADO
2550	PF A/A CH RETA 3,5 X 19 MM ZINCADO
2551	PF A/A CH RETA 3,5 X 25 MM ZINCADO
2552	PF A/A CH RETA 3,9 X 13 MM ZINCADO
2788	PF A/A CH RETA 3,9 X 32 MM ZINCADO
2555	PF A/A CH RETA 4,2 X 13 MM ZINCADO
2556	PF A/A CH RETA 4,2 X 19 MM ZINCADO
2557	PF A/A CH RETA 4,2 X 25 MM ZINCADO
2558	PF A/A CH RETA 4,2 X 32 MM ZINCADO
2559	PF A/A CH RETA 4,2 X 38 MM ZINCADO
2560	PF A/A CH RETA 4,8 X 25 MM ZINCADO
2561	PF A/A CH RETA 4,8 X 32 MM ZINCADO
2562	PF A/A CH RETA 4,8 X 38 MM ZINCADO
2563	PF A/A CH RETA 5,5 X 32 MM ZINCADO
2564	PF A/A CH RETA 6,3 X 19 MM ZINCADO



CÓD.	DESCRIÇÃO
7813	GRAMPO GALVANIZADO 106/6 COM 1.000 UNIDADES
7814	GRAMPO GALVANIZADO 106/8 COM 1.000 UNIDADES



CÓD.	DESCRIÇÃO
2412	PF MADEIRA FD RETA 3,5 X 30 MM ZINCADO
2413	PF MADEIRA FD RETA 4,2 X 40 MM ZINCADO
2414	PF MADEIRA FD RETA 4,5 X 40 MM ZINCADO
2415	PF MADEIRA FD RETA 4,8 X 40 MM ZINCADO
2416	PF MADEIRA FD RETA 4,8 X 50 MM ZINCADO
2417	PF MADEIRA FD RETA 5,5 X 45 MM ZINCADO
2418	PF MADEIRA FD RETA 5,5 X 50 MM ZINCADO
2419	PF MADEIRA FD RETA 5,5 X 65 MM ZINCADO
2420	PF MADEIRA FD RETA 6,1 X 90 MM ZINCADO
4757	PF MADEIRA FENDA RETA 3/8X3MM ZINCADO



CÓD.	DESCRIÇÃO
8461	KIT TACHINHAS LATONADAS DOURADAS



CÓD.	DESCRIÇÃO
8566	ARRUELA LISA 1/2 ZINCADA KG
8563	ARRUELA LISA 1/4 ZINCADA KG
8562	ARRUELA LISA 3/16 ZINCADA KG
8567	ARRUELA LISA 3/4 ZINCADA KG
8565	ARRUELA LISA 3/8 ZINCADA KG
8564	ARRUELA LISA 5/16 ZINCADA KG



CÓD.	DESCRIÇÃO
2847	ARRUELA LISA 1/2 ZINCADA
2409	ARRUELA LISA 1/4 ZINCADA
2728	ARRUELA LISA 3/4 ZINCADA
2406	ARRUELA LISA 1/8 ZINCADA
2411	ARRUELA LISA 3/8 ZINCADA
2408	ARRUELA LISA 3/16 ZINCADA
3257	ARRUELA LISA 5/8 ZINCADA
2410	ARRUELA LISA 5/16 ZINCADA
2407	ARRUELA LISA 5/32 ZINCADA
2726	ARRUELA LISA 7/16 ZINCADA
2727	ARRUELA LISA 9/16 ZINCADA

PINTURA

ULTRA
/// ATACADISTA

**TEK
BOND**

SAINT-GOBAIN

A GENTE COLA COM VOCE

Imagens meramente ilustrativas



Descubra as soluções que a Tekbond oferece em:
TEKBOND.COM.BR    **TEKBONDOfICIAL**

SAINT-GOBAIN

Tinta spray premium



TINTA SPRAY USO GERAL USO EXTERNO/INTERNO

AMARELO CÓD. 8700	AZUL CLARO CÓD. 8701	AZUL ESCURO CÓD. 8702	AZUL MÉDIO CÓD. 8703
BEGE CÓD. 8704	BRANCO BRILHANTE CÓD. 8705	BRANCO FOSCO CÓD. 8706	CINZA PRIMER CÓD. 8710
CINZA ESCURO CÓD. 8708	CINZA MÉDIO CÓD. 8709	CINZA CLARO CÓD. 8707	LARANJA CÓD. 8711
MARROM CÓD. 8712	PRETO BRILHANTE CÓD. 8713	PRETO FOSCO CÓD. 8714	PRETO SEMI-BRILHO CÓD. 8715
ROSA CÓD. 8716	VERDE CLARO CÓD. 8717	VERDE ESCURO CÓD. 8718	VERMELHO CÓD. 8719
VERNIZ CÓD. 8810			

TINTA SPRAY METÁLICA USO EXTERNO/INTERNO

CROMADA CÓD. 8695	PRATA CÓD. 8699	GRAFITE CÓD. 8697
OURO CÓD. 8698	DOURADO CÓD. 8696	COBRE CÓD. 8694

TINTA SPRAY ALTA TEMPERATURA USO EXTERNO

ALUMÍNIO CÓD. 8692	PRETO FOSCO CÓD. 8693

ULTRA

/// TINTAS

TINTA LATÉX PROFISSIONAL

	COR:	18L	3,6L	900ML
AMARELO CANARIO		1403	1404	
AREIA		1393	1394	
AZUL BAHAMAS		1411	1412	
BRANCO		1385	1386	2588
CAMURÇA		1401	1402	
GELO		1387	1388	
MARFIM		1391	1392	
PALHA		1389	1390	
PÉROLA		2106	2107	
PÊSSEGO		1397	1398	
VAPOR DE ÁGUA CINZA		4200	4201	
VERDE ÁGUA		1407	1408	
VERDE KIWI		1415	1416	

COMPLEMENTOS PREMIUM

DESCRIÇÃO:	EMBALAGEM:
800 - MASSA ACRÍLICA	1/4
801 - MASSA ACRÍLICA	3,6L
1819 - MASSA ACRÍLICA	25KG
798 - MASSA CORRIDA PVA	1/4
799 - MASSA CORRIDA PVA	3,6L
797 - MASSA CORRIDA PVA	25KG
802 - SELADOR ACRÍLICO BRANCO	3,6L
796 - SELADOR ACRÍLICO BRANCO	14L
2091 - TEXTURA RÚSTICA	25KG
1348 - GRAFIATO	25KG



**7005 - BROXA PARA PINTURA
RETANGULAR 150X58MM**

**7124 - MISTURADOR DE FERRO
PARA TINTAS E ARGAMASSAS**

PINTURA



THOMPSON

CÓD.	DESCRIÇÃO
3098	BANDEJA PARA PINTURA MEDIA THOMPSON
3099	BANDEJA PARA PINTURA GRANDE THOMPSON



ATLAS
PREÇOS E FUNDAMENTOS

CÓD.	DESCRIÇÃO
2365	BANDEJA P/ PINTURA DE PLASTICO PT 1,3L ATLAS
2364	BANDEJA P/ PINTURA DE PLASTICO PT 2,7L ATLAS
2363	BANDEJA P/ PINTURA DE PLASTICO PT 3,6L ATLAS



metasul

CÓD.	DESCRIÇÃO
1452	BANDEJA P/ PINTURA GRANDE METASUL PRETA



TIGRE

CÓD.	DESCRIÇÃO
8916	ÇAÇAMBA PLÁSTICA 14 LITROS 1319



TIGRE

CÓD.	DESCRIÇÃO
7072	CONJ. DE PINTURA ECONOMICO 3 PECAS



TIGRE

CÓD.	DESCRIÇÃO
7336	CONJ. DE PINTURA 1576 ANTIRRESPINGO 3 PECAS



ATLAS
PREÇOS E FUNDAMENTOS

CÓD.	DESCRIÇÃO
2343	CONJUNTO DE PINTURA BASICO



ATLAS
PREÇOS E FUNDAMENTOS

CÓD.	DESCRIÇÃO
2345	CONJUNTO PINTURA E ACABAMENTO



ATLAS
PREÇOS E FUNDAMENTOS

CÓD.	DESCRIÇÃO
2344	CONJUNTO DE PINTURA ANTIRRESPINGO



TIGRE

CÓD.	DESCRIÇÃO
7333	GARFO P/ ROLO 23CM C/ BUCHA TIGRE



TIGRE

CÓD.	DESCRIÇÃO
7120	GARFO P/ ROLO GAIOLA 23CM TIGRE



ATLAS
PREÇOS E FUNDAMENTOS

CÓD.	DESCRIÇÃO
2360	GARFO P/ ROLO GAIOLA 23 CM



ATLAS
PREÇOS E FUNDAMENTOS

CÓD.	DESCRIÇÃO
2359	GARFO P/ ROLO 23CM C/BUCHA



TIGRE

CÓD.	DESCRIÇÃO
7070	ROLO LA 09 CM ANTIRRESPINGO TIGRE
7071	ROLO LA 15 CM ANTIRRESPINGO TIGRE



COMPEL

CÓD.	DESCRIÇÃO
4961	ROLO DE ESPUMA 15 CM POP AMARELO

PINTURA



CÓD.	DESCRIÇÃO
7084	ROLO DE ESPUMA 05 CM CINZA TIGRE
7085	ROLO DE ESPUMA 09 CM CINZA TIGRE
7086	ROLO DE ESPUMA 15 CM CINZA TIGRE
7087	ROLO DE ESPUMA 23 CM CINZA TIGRE



CÓD.	DESCRIÇÃO
2336	ROLO 705 ROLA FACIL 5 CM
23372338	ROLO 709 ROLA FACIL 09 CM
2338	ROLO 715 ROLA FACIL 15CM



CÓD.	DESCRIÇÃO
2333	ROLO 321 ANTIGOTA POLIAMIDA 5 CM
23322333	ROLO 321 ANTIGOTA POLIAMIDA 9 CM
23312333	ROLO 321 ANTIGOTA POLIAMIDA 15 CM
2330	ROLO 321 ANTIGOTA POLIAMIDA 23 CM



CÓD.	DESCRIÇÃO
7149	ROLO 328 LA NATURAL 9CM ATLAS



CÓD.	DESCRIÇÃO
2341	ROLO 406 ESPUMA CINZA 5 CM C/ CABO
23422339	ROLO 406 ESPUMA CINZA 9 CM C/ CABO
2339	ROLO 406 ESPUMA CINZA 15 CM C/ CABO



CÓD.	DESCRIÇÃO
7081	ROLO EXTRA DE PELE DE CARNEIRO 23CM REF. 1322



CÓD.	DESCRIÇÃO
3404	ROLO DE PINTURA ECONO LÃ SINT. 23CM



CÓD.	DESCRIÇÃO
7335	ROLO PARA TEXTURA 23CM 1352 TIGRE

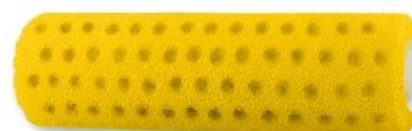

CÓD.	DESCRIÇÃO
7143	ROLO PARA TEXTURA 23 CM ATLAS



CÓD.	DESCRIÇÃO
6861	ROLO DE PINTURA BRASILEIRINHO POLIAMIDA 23CM



CÓD.	DESCRIÇÃO
7083	ROLO LA 23 CM ANTIRRESPINGO ECONOMICO



CÓD.	DESCRIÇÃO
6536	ROLO PARA MASSA NIVELPRO 23CM



CÓD.	DESCRIÇÃO
5813	ROLO GOL PELE DE CARNEIRO 23CM



CÓD.	DESCRIÇÃO
2575	ROLO 322 EXTRA DE PELE DE CARNEIRO 23 CM



CÓD.	DESCRIÇÃO
2329	ROLO 228 LA MISTA 23CM

PINTURA



ATLAS
PINTURAS E FERRAMENTAS

CÓD.	DESCRIÇÃO
2335	ROLO 773 ANTIRESP. LA SINTI. 23 CM



ATLAS
PINTURAS E FERRAMENTAS

CÓD.	DESCRIÇÃO
2334	ROLO 327 RENDEPLUS MICROFIBRA 23CM 10MM
3971	ROLO 327 RENDEPLUS MICROFIBRA 23CM 19MM



BOMVINK

CÓD.	DESCRIÇÃO
8321	ROLO DE PINTURA DE LÃ 23CM



ATLAS
PINTURAS E FERRAMENTAS

CÓD.	DESCRIÇÃO
2328	ROLO 228 MAXI LA 23 CM
7331	BROXA P/PINTURA REDONDA PLASTICA TIGRE



TIGRE

CÓD.	DESCRIÇÃO
7082	ROLO DE PINTURA ECONO LA SINT. 23CM TIGRE



TIGRE

CÓD.	DESCRIÇÃO
7332	BROXA P/PINTURA RETANGULAR 152X56X195MM



ATLAS
PINTURAS E FERRAMENTAS

CÓD.	DESCRIÇÃO
2713	BROXA P/PINTURA JUMBO 18X8CM ATLAS



ATLAS
PINTURAS E FERRAMENTAS

CÓD.	DESCRIÇÃO
3972	BROXA P/PINTURA REDONDA MONOFIBRA ATLAS



ATLAS
PINTURAS E FERRAMENTAS

CÓD.	DESCRIÇÃO
2712	BROXA P/PINTURA REDONDA PLASTICA 7,5CM ATLAS



ATLAS
PINTURAS E FERRAMENTAS

CÓD.	DESCRIÇÃO
2710	BROXA P/PINTURA RETANGULAR 15X5.6CM ATLAS
2711	BROXA P/PINTURA RETANGULAR 18X8CM ATLAS



BOMVINK

CÓD.	DESCRIÇÃO
8353	FITA TELADA AUTOADESIVA 5CM X 45M



THOMPSON

CÓD.	DESCRIÇÃO
9031	ESCOVA DE AÇO 3 FILEIRAS
9032	ESCOVA DE AÇO 6 FILEIRAS



ATLAS
PINTURAS E FERRAMENTAS

CÓD.	DESCRIÇÃO
6537	CONJUNTO ESCOVAS PARA LIMPEZA PESADA
6538	CONJUNTO ESCOVAS MULTIUSO



ATLAS
PINTURAS E FERRAMENTAS

CÓD.	DESCRIÇÃO
2286	ESCOVA DE AÇO 3 FILEIRAS
2287	ESCOVA DE AÇO 6 FILEIRAS



TIGRE

CÓD.	DESCRIÇÃO
7073	TRINCHA TIGRE 695 P/PINTURA 1/2 CERDA GRIS
7074	TRINCHA TIGRE 695 P/PINTURA 3/4 CERDA GRIS
7075	TRINCHA TIGRE 695 P/PINTURA 1 CERDA GRIS
7076	TRINCHA TIGRE 695 P/PINTURA 1.1/2 CERDA GRIS
7077	TRINCHA TIGRE 695 P/PINTURA 2 CERDA GRIS
7078	TRINCHA TIGRE 695 P/PINTURA 2.1/2 CERDA GRIS
7079	TRINCHA TIGRE 695 P/PINTURA 3 CERDA GRIS
7080	TRINCHA TIGRE 695 P/PINTURA 4 CERDA GRIS

PINTURA



CÓD.	DESCRIÇÃO
2346	PINCEL ARTISTICO ACHATADO LONGO 0
23472348	PINCEL ARTISTICO ACHATADO LONGO 2
23482350	PINCEL ARTISTICO ACHATADO LONGO 4
23502352	PINCEL ARTISTICO ACHATADO LONGO 8
23522354	PINCEL ARTISTICO ACHATADO LONGO 12
23542356	PINCEL ARTISTICO ACHATADO LONGO 16
2357	PINCEL ARTISTICO ACHATADO LONGO 22

2349	PINCEL ACHATADO 6
23512353	PINCEL ACHATADO 10
23532355	PINCEL ACHATADO 14
23552356	PINCEL ACHATADO 18
23562358	PINCEL ACHATADO 20
2358	PINCEL ACHATADO 24



CÓD.	DESCRIÇÃO
2319	TRINCHA 419 P/ PINTURA 1/2 STAINVER
23202321	TRINCHA 419 P/ PINTURA 3/4 STAINVER
23212322	TRINCHA 419 P/ PINTURA 1 STAINVER
23222323	TRINCHA 419 P/ PINTURA 1.1/2 STAINVER
23232324	TRINCHA 419 P/ PINTURA 2 STAINVER
23242325	TRINCHA 419 P/ PINTURA 2.1/2 STAINVER
23252326	TRINCHA 419 P/ PINTURA 3 STAINVER
2326	TRINCHA 419 P/ PINTURA 4 STAINVER



CÓD.	DESCRIÇÃO
2303	TRINCHA 315 P/ PINTURA 1/2 PLUMATEK
23042305	TRINCHA 315 P/ PINTURA 3/4 PLUMATEK
23052306	TRINCHA 315 P/ PINTURA 1 PLUMATEK
23062307	TRINCHA 315 P/ PINTURA 1.1/2 PLUMATEK
23072308	TRINCHA 315 P/ PINTURA 2 PLUMATEK
23082309	TRINCHA 315 P/ PINTURA 2.1/2 PLUMATEK
23092310	TRINCHA 315 P/ PINTURA 3 PLUMATEK
2310	TRINCHA 315 P/ PINTURA 4 PLUMATEK



CÓD.	DESCRIÇÃO
2311	TRINCHA 417 P/ PINTURA 1/2 LATEXACRIL
23122313	TRINCHA 417 P/ PINTURA 3/4 LATEXACRIL
23132314	TRINCHA 417 P/ PINTURA 1 LATEXACRIL
23142315	TRINCHA 417 P/ PINTURA 1.1/2 LATEXACRIL
23152316	TRINCHA 417 P/ PINTURA 2 LATEXACRIL
23162317	TRINCHA 417 P/ PINTURA 2.1/2 LATEXACRIL
23172318	TRINCHA 417 P/ PINTURA 3 LATEXACRIL
2318	TRINCHA 417 P/ PINTURA 4 LATEXACRIL



CÓD.	DESCRIÇÃO
4945	TRINCHA 1 CERDAS GRIS CABO AMARELO
49464947	TRINCHA 1.1/2 CERDAS GRIS CABO AMARELO
49434947	TRINCHA 1/2 CERDAS GRIS CABO AMARELO
49474948	TRINCHA 2 CERDAS GRIS CABO AMARELO
49484949	TRINCHA 2.1/2 CERDAS GRIS CABO AMARELO
49494949	TRINCHA 3 CERDAS GRIS CABO AMARELO
49444950	TRINCHA 3/4 CERDAS GRIS CABO AMARELO
4950	TRINCHA 4 CERDAS GRIS CABO AMARELO



CÓD.	DESCRIÇÃO
2707	TRINCHA 319 P/ PINTURA 1/2
27082714	TRINCHA 319 P/ PINTURA 3/4
27142715	TRINCHA 319 P/ PINTURA 1
27152709	TRINCHA 319 P/ PINTURA 1.1/2
27092716	TRINCHA 319 P/ PINTURA 2
27162717	TRINCHA 319 P/ PINTURA 2.1/2
27172718	TRINCHA 319 P/ PINTURA 3
2718	TRINCHA 319 P/ PINTURA 4



CÓD.	DESCRIÇÃO
2295	TRINCHA 395 P/ PINTURA 1/2
22962297	TRINCHA 395 P/ PINTURA 3/4
22972298	TRINCHA 395 P/ PINTURA 1
22982299	TRINCHA 395 P/ PINTURA 1.1/2
22992300	TRINCHA 395 P/ PINTURA 2
23002301	TRINCHA 395 P/ PINTURA 2.1/2
23012302	TRINCHA 395 P/ PINTURA 3
2302	TRINCHA 395 P/ PINTURA 4



CÓD.	DESCRIÇÃO
8294	VERNIZ POLIREX INBUIA 900ML
8293	VERNIZ POLIREX INBUIA 3.6L8295
8295	VERNIZ POLIREX MOGNO 3.6L8296
8296	VERNIZ POLIREX MOGNO 225ML8297
8297	VERNIZ POLIREX MOGNO 900ML

VERNIZ
VERNIZ
V



CÓD.	DESCRIÇÃO
8298	VERNIZ SAYERMAR EXTRA MARÍTIMO 3,0L
8299	VERNIZ SAYERMAR EXTRA MARÍTIMO 750ML



CÓD.	DESCRIÇÃO
8300	VERNIZ POLISTEN TRANSPARENTE 3,6 STEIN
83018852	VERNIZ POLISTEN TRANSPARENTE 900ML STEIN
88528853	VERNIZ POLISTEN NATURAL 900ML STAIN
88538854	VERNIZ POLISTEN NATURAL 3.6L STAIN
88548855	VERNIZ POLISTEN IMBUIA 900ML STAIN
88558856	VERNIZ POLISTEN IMBUIA 3.6L STAIN
88568857	VERNIZ POLISTEN MOGNO INGLÊS 900 STAIN
8857	VERNIZ POLISTEN MOGNO INGLÊS 3.6 STAIN



CÓD.	DESCRIÇÃO
8860	VERNIZ POLIULACK BRILHANTE 900 ML
8859	VERNIZ POLIULACK BRILHANTE 3.6L
8858	VERNIZ POLIULACK BRILHANTE 225ML
8861	VERNIZ POLIULACK ACETINADO 900ML
8862	VERNIZ POLIULACK ACETINADO 3.6L



CÓD.	DESCRIÇÃO
8302	MASSA PARA MADEIRA 380G BRANCA
83038304	MASSA PARA MADEIRA 380G INBUIA/TABACO
83048305	MASSA PARA MADEIRA 380G MOGNO
8305	MASSA PARA MADEIRA 380G EUCALIPTO



CÓD.	DESCRIÇÃO
8291	SELADORA EXTRA PARA MADEIRA 3.6L
8292	SELADORA EXTRA PARA MADEIRA 900ML



CÓD.	DESCRIÇÃO
4122	MASSA PARA MADEIRA BASE ACRIL. BRANCO 350G
4123	MASSA PARA MADEIRA BASE ACRIL. IMBUIA 350G
4125	MASSA PARA MADEIRA BASE ACRIL. MOGNO 350G

PINTURA



CÓD. DESCRIÇÃO
4889 FUNDO PREPARADOR 18L NOVA
4890 FUNDO PREPARADOR 3,6 NOVA



CÓD. DESCRIÇÃO
7240 AGUARRAZ NOVA 5L



CÓD. DESCRIÇÃO
8288 AGUARRÁS 900ML



CÓD. DESCRIÇÃO
8287 AGUARRÁS 5 LITROS



CÓD. DESCRIÇÃO
1093 QUEROSENE 0,9ml



CÓD. DESCRIÇÃO
1090 THINNER MULTIUSO 5L
1089 THINNER MULTIUSO 0,9ml



CÓD. DESCRIÇÃO
4055 QUEROSENE 5 LITROS



CÓD. DESCRIÇÃO
8285 THINNER 5 LITROS
8286 THINNER 900ML



CÓD. DESCRIÇÃO
7582 TINTA EMBORRACHADA BRANCA NOVA 18L



CÓD. DESCRIÇÃO
8987 ESMALTE FUNDO E ACABAMENTO AC. PRETO 3.6L
8988 ESMALTE FUNDO E ACABAMENTO AC. PRETO 900 ML
8985 ESMALTE FUNDO E ACABAMENTO AC. BRANCO 3.6L
8986 ESMALTE FUNDO E ACABAMENTO AC. BRANCO 900ML
8997 ESMALTE FUNDO E ACABAMENTO AC. AZUL 3.6L
8998 ESMALTE FUNDO E ACABAMENTO AC. AZUL 900ML
8999 ESMALTE FUNDO E ACABAMENTO AC. CINZA 3.6L
9000 ESMALTE FUNDO E ACABAMENTO AC. CINZA 900ML



CÓD. DESCRIÇÃO
7047 ESMALTE SINTETICO AMARELO 3,6L
7048 ESMALTE SINTETICO AMARELO 900ML
7043 ESMALTE SINTETICO AZUL DELREY 3,6L
7044 ESMALTE SINTETICO AZUL DELREY 900ML
7045 ESMALTE SINTETICO AZUL FRANCA 3,6L
7046 ESMALTE SINTETICO AZUL FRANCA 900ML
7039 ESMALTE SINTETICO BRANCO 3,6L
7040 ESMALTE SINTETICO BRANCO 900ML
7055 ESMALTE SINTETICO CINZA ESCURO 3,6L
7056 ESMALTE SINTETICO CINZA ESCURO 900ML
7053 ESMALTE SINTETICO CINZA MEDIO 3,6L
7054 ESMALTE SINTETICO CINZA MEDIO 900ML
7041 ESMALTE SINTETICO GELO 3,6L
7042 ESMALTE SINTETICO GELO 900ML
7059 ESMALTE SINTETICO MARROM 3,6L
7060 ESMALTE SINTETICO MARROM 900ML
7057 ESMALTE SINTETICO PRETO 3,6L
7058 ESMALTE SINTETICO PRETO 900ML
7051 ESMALTE SINTETICO VERDE FOLHA 3,6L
7052 ESMALTE SINTETICO VERDE FOLHA 900ML
7049 ESMALTE SINTETICO VERMELHO 3,6L
7050 ESMALTE SINTETICO VERMELHO 900ML



CÓD. DESCRIÇÃO
4792 TINTA PISO VERDE 18L
4793 TINTA PISO VERDE 3,6L
4794 TINTA PISO CINZA CHUMBO 18L
4795 TINTA PISO CINZA CHUMBO 3,6L
4887 TINTA PISO CONCRETO 18L
4888 TINTA PISO CONCRETO 3,6L
5380 TINTA PISO AMARELO 18L
5381 TINTA PISO AMARELO 3,6L
5382 TINTA PISO BRANCO 18L
5383 TINTA PISO BRANCO 3,6L
6173 TINTA PISO CINZA 18L
6174 TINTA PISO CINZA 3,6L NOVA
7167 TINTA PISO AZUL 18L NOVA
7168 TINTA PISO VERMELHO 18L NOVA
7337 TINTA PISO VERMELHO 3,6L NOVA



CÓD. DESCRIÇÃO
4835 TINTA BRANCO 16L LATEX INTERIOR BALDE
6403 TINTA GELO 16L LATEX INTERIOR BALDE

PINTURA

ULTRA
TINTAS



CÓD.	DESCRIÇÃO
1404	TINTA AMARELO CANARIO 3,6L LATEXPROF.
1403	TINTA AMARELO CANARIO 18L LATEXPROF.
1394	TINTA AREIA 3,6L LATEXPROF.
1393	TINTA AREIA 18L LATEXPROF.
1412	TINTA AZUL BAHAMAS 3,6L LATEXPROF.
1411	TINTA AZUL BAHAMAS 18L LATEXPROF.
2588	TINTA BRANCO 900ML LATEXPROF.
1386	TINTA BRANCO 3,6L LATEXPROF.
1385	TINTA BRANCO 18L LATEXPROF.
1402	TINTA CAMURÇA 3,6L LATEXPROF.
1401	TINTA CAMURÇA 18L LATEXPROF.
1388	TINTA GELO 3,6L LATEXPROF.
1387	TINTA GELO 18L LATEXPROF.

CÓD.	DESCRIÇÃO
1390	TINTA PALHA 3,6L LATEXPROF.
1389	TINTA PALHA 18L LATEXPROF.
2107	TINTA PEROLA 3,6L LATEXPROF.
2106	TINTA PEROLA 18L LATEXPROF.
1398	TINTA PESSEGO 3,6L LATEXPROF.
1397	TINTA PESSEGO 18L LATEXPROF.
8816	TINTA CROMIO 3,6L LATEX PROF.
8815	TINTA CROMIO 18L LATEX PROF.

TEK
BOND
SAINT-GOBAIN



CÓD.	DESCRIÇÃO
2245	SPRAY ALUMINIO ALTA TEMP. 350ML
2242241	SPRAY ALUMINIO 350ML
22412227	SPRAY AMARELO FLUORESCENTE 350ML
22272228	SPRAY AMARELO 350ML
22282230	SPRAY AZUL CLARO 350ML
22302246	SPRAY AZUL ESCURO 350ML
22462229	SPRAY AZUL METALICO 350ML
22292236	SPRAY AZUL USO GERAL 350ML
22362223	SPRAY BEGE USO GERAL 350ML
22232231	SPRAY BRANCO BRILHANTE 350ML
22312904	SPRAY BRANCO FOSCO 350ML
29042260	SPRAY COBRE METALICO 350ML
22602261	SPRAY CROMADO METALICO 350ML
22612226	SPRAY DOURADO METALICO 350ML
22262232	SPRAY DOURADO 350ML
22322242	SPRAY GRAFITE 350ML
22422233	SPRAY LARANJA FLUORESCENTE 350ML
2233	SPRAY LARANJA 350ML

CÓD.	DESCRIÇÃO
2237	SPRAY MARROM 350ML
22583767	SPRAY OURO METALICO 350ML
37672259	SPRAY PLATINA 350ML
22592244	SPRAY PRATA METALICO 350ML
22442222	SPRAY PRETO BRILHANTE ALTA TEMP. 350ML
2223769	SPRAY PRETO BRILHANTE 350ML
37692221	SPRAY PRETO FOSCO ALTA TEMP. 350ML
22213017	SPRAY PRETO FOSCO 350ML
30172239	SPRAY PRETO METALICO 350ML
22392243	SPRAY PRIMER FUNDO 350ML
22432234	SPRAY ROSA FLUORESCENTE 350ML
22342240	SPRAY ROSA 350ML
22402247	SPRAY VERDE FLUORESCENTE 350ML
22472235	SPRAY VERDE METALICO 350ML
22352248	SPRAY VERDE 350ML
22482225	SPRAY VERMELHO METALICO 350ML
22252238	SPRAY VERMELHO 350ML
2238	SPRAY VERNIZ 350ML

ULTRA
COLORS



CÓD.	DESCRIÇÃO
8700	SPRAY AMARELO 300ML
8701	SPRAY AZUL CLARO 300 ML
8702	SPRAY AZUL ESCURO 300ML
8703	SPRAY AZUL MÉDIO 300ML
8704	SPRAY BEGE 300ML
8705	SPRAY BRANCO BRILHANTE 300ML
8706	SPRAY BRANCO FOSCO 300ML
8707	SPRAY CINZA CLARO 300ML
8708	SPRAY CINZA ESCURO 300ML
8709	SPRAY CINZA MÉDIO 300ML
8710	SPRAY CINZA PRIMER 300ML
8711	SPRAY LARANJA 300ML
8712	SPRAY MARROM 300ML
8713	SPRAY PRETO BRILHANTE 300ML
8714	SPRAY PRETO FOSCO 300ML
8715	SPRAY PRETO SEMI- BRILHO (ACET.) 300ML
8716	SPRAY ROSA 300ML
8717	SPRAY VERDE CLARO 300ML
8718	SPRAY VERDE ESCURO 300ML
8719	SPRAY VERMELHO 300ML

CÓD.	DESCRIÇÃO
8694	SPRAY COBRE METÁLICO 300ML
8695	SPRAY CROMADO METÁLICO 300ML
8696	SPRAY DOURADO METÁLICO 300ML
8697	SPRAY GRAFITE METÁLICO 300ML
8698	SPRAY OURO METÁLICO 300ML
8699	SPRAY PRATA METÁLICO 300ML

CÓD.	DESCRIÇÃO
8810	SPRAY ULTRACOLORS VERNIZ 300ML

CÓD.	DESCRIÇÃO
8692	SPRAY ALUMÍNIO ALTA TEMPERATURA 300ML
8693	SPRAY PRETO FOSCO ALTA T. METÁLICO 300ML

CIBRA
PAINTS DO BRASIL



CÓD.	DESCRIÇÃO
7566	SPRAY CROMADO METÁLICO
7567	SPRAY AZUL ESCURO
7568	SPRAY BEGE
7569	SPRAY BRANCO BRILHANTE
7570	SPRAY BRANCO FOSCO
7571	SPRAY DOURADO METÁLICO
7572	SPRAY LARANJA
7573	SPRAY MARROM
7574	SPRAY PRETO BRILHANTE
7575	SPRAY PRETO FOSCO
7576	SPRAY OURO METÁLICO
7577	SPRAY PRIMER CINZA
7578	SPRAY ROSA
7579	SPRAY VERDE ESCURO
7580	SPRAY VERMELHO
7581	SPRAY VERNIZ
7593	SPRAY AMARELO

TEK
BOND
SAINT-GOBAIN



CÓD.	DESCRIÇÃO
6508	CORANTE PRETO LIQUIDO 50 ML
65096510	CORANTE VERDE LIQUIDO 50 ML
65106511	CORANTE VERMELHO LIQUIDO 50 ML
65116512	CORANTE VIOLETA LIQUIDO 50 ML
65126513	CORANTE AMARELO LIQUIDO 50 ML
65136514	CORANTE AZUL LIQUIDO 50 ML
65146515	CORANTE BRANCO LIQUIDO 50 ML
65156516	CORANTE LARANJA LIQUIDO 50 ML
65166517	CORANTE MARROM LIQUIDO 50 ML
6517	CORANTE OCRE LIQUIDO 50 ML

ULTRA
ATACADISTA

145

PINTURA

ULTRA
TINTAS



CÓD.	DESCRIÇÃO
800	MASSA ACRILICA 1/4
801	MASSA ACRILICA 3,6L
1819	MASSA ACRILICA 25 KG - BALDE
798	MASSA CORRIDA PVA 1/4
799	MASSA CORRIDA PVA 3,6L
797	MASSA CORRIDA PVA 25 KG - BALDE
802	SELADOR ACRILICO BRANCO 3,6L
796	SELADOR ACRILICO BRANCO 14 L - BALDE
2091	TEXTURA RUSTICA 25 KG - BALDE
1348	GRAFIATO 25 KG - BALDE

LANXESS
Energizing Chemistry



CÓD.	DESCRIÇÃO
7739	CORANTE EM PÓ 250G AMARELO
7740	CORANTE EM PÓ 250G AZUL
7741	CORANTE EM PÓ 250G MARROM
7742	CORANTE EM PÓ 250G PRETO
7743	CORANTE EM PÓ 250G VERDE
7744	CORANTE EM PÓ 250G VERMELHO
7745	CORANTE EM PÓ 500G AMARELO
7746	CORANTE EM PÓ 500G AZUL
7747	CORANTE EM PÓ 500G MARROM
7748	CORANTE EM PÓ 500G PRETO
7749	CORANTE EM PÓ 500G VERDE
7750	CORANTE EM PÓ 500G VERMELHO



ATLAS
PREÇOS E FORMAS DE PAGAMENTO

CÓD.	DESCRIÇÃO
8273	FIBRA ABRASIVA PARA MADEIRA 115X290MM



ATLAS
PREÇOS E FORMAS DE PAGAMENTO

CÓD.	DESCRIÇÃO
8274	FIBRA ABRASIVA ELIMINA FERRUGEM 115X290MM



ATLAS
PREÇOS E FORMAS DE PAGAMENTO

CÓD.	DESCRIÇÃO
8322	FIBRA ABRASIVA ACABAMENTOS 115X290MM



SAYERLACK

CÓD.	DESCRIÇÃO
8284	REMOVEDOR PASTOSO GEL SUPER 900ML



IBERÊ

CÓD.	DESCRIÇÃO
7852	REMOVEDOR LIQUIDO DE TINTAS REMOVE 900ML



Nova

CÓD.	DESCRIÇÃO
4775	ZARCAO FUNDO FERRAGENS 3,6 LTS
4776	ZARCAO FUNDO FERRAGENS 900 MLS



Nova

CÓD.	DESCRIÇÃO
6220	BETUME 100ML NOVA



Mococa

CÓD.	DESCRIÇÃO
4129	TINGIDOR DURA VERN. E SELAD. IMBUIA 200ML
4130	TINGIDOR DURA VERN. E SELAD. JATOBÁ 200ML
4131	TINGIDOR DURA VERN. E SELAD. MAGNO 200ML



Mococa

CÓD.	DESCRIÇÃO
4091	CLAREADOR DE MADEIRA SAL AZEDO 1L
4092	CLAREADOR DE MADEIRA SAL AZEDO 500ML



Mococa

CÓD.	DESCRIÇÃO
4126	ÓLEO DE LINHAÇA 900ML



ATLAS
PREÇOS E FORMAS DE PAGAMENTO

CÓD.	DESCRIÇÃO
2724	PAD PARA RECORTE EM PINTURA



TEK BOND
SAINT-GOBAIN

CÓD.	DESCRIÇÃO
7677	ESTOPA PARA POLIMENTO E LIMPEZA 150G
7678	ESTOPA PARA POLIMENTO E LIMPEZA 400G

PINTURA



CÓD. DESCRIÇÃO
1048 GESSO RÁPIDO



CÓD. DESCRIÇÃO
1537 PALHA ACO N 0 ACOBOM
15381539 PALHA ACO N 1 ACOBOM
1539 PALHA ACO N 2 ACOBOM

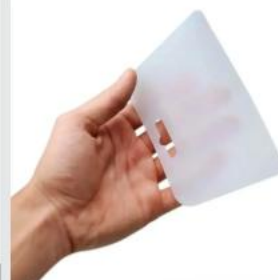

CÓD. DESCRIÇÃO
7142 ESPATULA PLASTICA 13,1 CM ATLAS



CÓD. DESCRIÇÃO
2293 SUPORTE MANUAL P/ LIXA
2294 SUPORTE P/ LIXA C/ ROSCA



CÓD. DESCRIÇÃO
2293 SUPORTE MANUAL P/ LIXA
2294 SUPORTE P/ LIXA C/ ROSCA



CÓD. DESCRIÇÃO
4968 BOINA PARA POLIMENTO N 05" LA CARNEIRO
4972 BOINA PARA POLIMENTO N 08" LA CARNEIRO



CÓD. DESCRIÇÃO
7819 PISTOLA DE AR DIRETO 1,3MM



CÓD. DESCRIÇÃO
7124 MISTURADOR DE FERRO P/ TINTAS E ARG. ULTRA



CÓD. DESCRIÇÃO
4957 MISTURADOR DE FERRO P/ TINTAS E ARG.



CÓD. DESCRIÇÃO
7121 PROLONGADOR DE AÇO 2M TIGRE
7122 PROLONGADOR DE AÇO 3M TIGRE



CÓD. DESCRIÇÃO
2361 PROLONGADOR DE AÇO 2 M
2362 PROLONGADOR DE AÇO 3 M



CÓD. DESCRIÇÃO
4401 LIXA FERRO/ACO 36 3M LIXA C/50 FOLHAS
44024403 LIXA FERRO/ACO 50 3M LIXA C/50 FOLHAS
44034404 LIXA FERRO/ACO 60 3M LIXA C/50 FOLHAS
44044405 LIXA FERRO/ACO 100 3M LIXA C/50 FOLHAS
44054406 LIXA FERRO/ACO 40 3M LIXA C/50 FOLHAS
44064407 LIXA FERRO/ACO 120 3M LIXA C/50 FOLHAS
44074408 LIXA FERRO/ACO 150 3M LIXA C/50 FOLHAS
44084409 LIXA FERRO/ACO 180 3M LIXA C/50 FOLHAS
44094464 LIXA FERRO/ACO 220 3M LIXA C/50 FOLHAS
4464 LIXA FERRO/ACO 80 3M LIXA C/ 50 FOLHAS

PINTURA



3M

CÓD.	DESCRIÇÃO
4410	LIXA MASSA/MADEIRA 60 3M C/ 50 FOLHAS
4411	LIXA MASSA/MADEIRA 80 3M C/ 50 FOLHAS
4412	LIXA MASSA/MADEIRA 220 3M C/ 50 FOLHAS
4413	LIXA MASSA/MADEIRA 180 3M C/ 50 FOLHAS
4414	LIXA MASSA/MADEIRA 150 3M C/ 50 FOLHAS
4415	LIXA MASSA/MADEIRA 120 3M C/ 50 FOLHAS
4416	LIXA MASSA/MADEIRA 100 3M C/ 50 FOLHAS
4417	LIXA D'AGUA 80 3M C/ 50 FOLHAS
4418	LIXA D'AGUA 100 3M C/ 50 FOLHAS
4419	LIXA D'AGUA 120 3M C/ 50 FOLHAS
4420	LIXA D'AGUA 150 3M C/ 50 FOLHAS
4421	LIXA D'AGUA 180 3M C/ 50 FOLHAS
4422	LIXA D'AGUA 220 3M C/ 50 FOLHAS
4448	LIXA D'AGUA 240 3M C/ 50 FOLHAS
4449	LIXA D'AGUA 280 3M C/ 50 FOLHAS
4450	LIXA D'AGUA 320 3M C/ 50 FOLHAS
4451	LIXA D'AGUA 360 3M C/ 50 FOLHAS
4452	LIXA D'AGUA 400 3M C/ 50 FOLHAS
4453	LIXA D'AGUA 600 3M C/ 50 FOLHAS
4454	LIXA D'AGUA 1200 3M C/ 50 FOLHAS

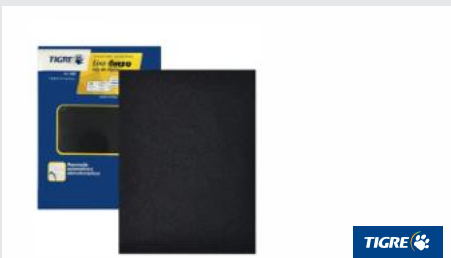

TIGRE

CÓD.	DESCRIÇÃO
7101	LIXA FERRO/ACO 36 TIGRE C/25 FOLHAS
7102	LIXA FERRO/ACO 40 TIGRE C/25 FOLHAS
7103	LIXA FERRO/ACO 50 TIGRE C/25 FOLHAS
7104	LIXA FERRO/ACO 60 TIGRE C/25 FOLHAS
7105	LIXA FERRO/ACO 80 TIGRE C/25 FOLHAS
7106	LIXA FERRO/ACO 100 TIGRE C/25 FOLHAS
7107	LIXA FERRO/ACO 120 TIGRE C/25 FOLHAS
7108	LIXA FERRO/ACO 150 TIGRE C/25 FOLHAS
7109	LIXA FERRO/ACO 180 TIGRE C/25 FOLHAS
7110	LIXA FERRO/ACO 220 TIGRE C/25 FOLHAS
7111	LIXA MASSA/MADEIRA 50 TIGRE C/ 25 FOLHAS
7112	LIXA MASSA/MADEIRA 60 TIGRE C/ 25 FOLHAS
7113	LIXA MASSA/MADEIRA 80 TIGRE C/ 25 FOLHAS
7114	LIXA MASSA/MADEIRA 100 TIGRE C/ 25 FOLHAS
7115	LIXA MASSA/MADEIRA 120 TIGRE C/ 25 FOLHAS
7116	LIXA MASSA/MADEIRA 150 TIGRE C/ 25 FOLHAS
7117	LIXA MASSA/MADEIRA 180 TIGRE C/ 25 FOLHAS
7118	LIXA MASSA/MADEIRA 220 TIGRE C/ 25 FOLHAS



TIGRE

CÓD.	DESCRIÇÃO
7088	LIXA DAGUA 80 TIGRE C/ 25 FOLHAS
7089	LIXA DAGUA 100 TIGRE C/ 25 FOLHAS
7090	LIXA DAGUA 120 TIGRE C/ 25 FOLHAS
7091	LIXA DAGUA 150 TIGRE C/ 25 FOLHAS
7092	LIXA DAGUA 180 TIGRE C/ 25 FOLHAS
7093	LIXA DAGUA 220 TIGRE C/ 25 FOLHAS
7094	LIXA DAGUA 240 TIGRE C/ 25 FOLHAS
7095	LIXA DAGUA 280 TIGRE C/ 25 FOLHAS
7096	LIXA DAGUA 320 TIGRE C/ 25 FOLHAS
7097	LIXA DAGUA 360 TIGRE C/ 25 FOLHAS
7098	LIXA DAGUA 400 TIGRE C/ 25 FOLHAS
7099	LIXA DAGUA 500 TIGRE C/ 25 FOLHAS
7100	LIXA DAGUA 600 TIGRE C/ 25 FOLHAS

FERRAMENTAS E UTILIDADES

ULTRA
/// ATACADISTA

ULTRA

/// FERRAMENTAS

7491 - BLOCO ESPUMA GIGANTE (FILTRO)



7420 - DESEMPENADEIRA PLÁSTICA 19X31 COM ESPUMA



7011 - PRUMO AÇO MACIÇO 500G



MARTELO BORRACHA PRETO PROFISSIONAL
7021 - 40MM
7016 - 60MM
7035 - 80MM



DISCO DIAMANTADO
LISO 6368 SEGMENTADO 6367 TURBO 6366



SERROTE BRONZE
7009 - 22"
7008 - 20"

7032 - ARCO DE SERRA FIXO



7019 - ESCOVA DE AÇO 3 FILEIRAS



THOMPSON

OS BEST SELLERS DA THOMPSON!

Qualidade comprovada por quem mais entende: **nossos clientes.**











- Disco Diamantado Turbo
- Disco de Corte Inox e Ferro
- Disco Flap
- Trena Emborrachada
- Trena Pop
- Corrente Galvanizada



FERRAMENTAS E UTILIDADES

 <p style="text-align: right;">TRAMONTINA</p>	 <p style="text-align: right;">TRAMONTINA</p>	 <p style="text-align: right;">BOMVINK</p>
<p>CÓD. 7718 DESCRIÇÃO FURADEIRA IMPACTO 1/2 500W 127V</p>	<p>CÓD. 8254 DESCRIÇÃO FURADEIRA IMPACTO 3/8 500W 127V</p>	<p>CÓD. 8254 DESCRIÇÃO FURADEIRA IMPACTO 1/2 500W 127V</p>
 <p style="text-align: right;">BOMVINK</p>	 <p style="text-align: right;">BOMVINK</p>	 <p style="text-align: right;">BOMVINK</p>
<p>CÓD. 8556 DESCRIÇÃO FURADEIRA/PARAF. IMPACTO 3/8 600W 110V</p>	<p>CÓD. 8257 DESCRIÇÃO MARTELETE 21V COM 2 BATERIAS/3.0Ah 4.500BPM</p>	<p>CÓD. 8489 DESCRIÇÃO MARTELETE PERF. E ROMPEDOR 127V 1480W</p>
 <p style="text-align: right;">BOMVINK</p>	 <p style="text-align: right;">TRAMONTINA</p>	 <p style="text-align: right;">TRAMONTINA</p>
<p>CÓD. 8561 DESCRIÇÃO MART. PERFURADOR E ROMP. 110V 60HZ 1000W</p>	<p>CÓD. 7670 DESCRIÇÃO PARAFUSADEIRA/FURADEIRA BATERIA 12V</p>	<p>CÓD. 7837 DESCRIÇÃO PARAF./FUR. BATERIA 12V COM MALETA 16 PEÇAS</p>
 <p style="text-align: right;">BOMVINK</p>	 <p style="text-align: right;">BOMVINK</p>	 <p style="text-align: right;">BOMVINK</p>
<p>CÓD. 8148 DESCRIÇÃO PARAFUSADEIRA/FURADEIRA BATERIA 21V</p>	<p>CÓD. 8868 DESCRIÇÃO PARAFUSADEIRA/FURADEIRA BAT. 21V C/ MALETA</p>	<p>CÓD. 8147 DESCRIÇÃO CHAVE DE FENDA ELÉTRICA 3.6V COM 12 PEÇAS</p>
 <p style="text-align: right;">BOMVINK</p>	 <p style="text-align: right;">TRAMONTINA</p>	 <p style="text-align: right;">BOMVINK</p>
<p>CÓD. 8826 DESCRIÇÃO CHAVE DE FENDA ELÉTRICA 3.6V MALETA 47 PEÇAS</p>	<p>CÓD. 5591 DESCRIÇÃO ESMERILHADEIRA 4.1/2 800 W - 127 V</p>	<p>CÓD. 8255 DESCRIÇÃO ESMERILHADEIRA ANGULAR 4. 1/2 127 710W</p>

FERRAMENTAS E UTILIDADES

 <p>BOMVINK</p>	 <p>BOMVINK</p>	 <p>TRAMONTINA</p>
<p>CÓD. DESCRIÇÃO 8319 ESMERILHADEIRA ANGULAR 4. 1/2 127V 850W</p>	<p>CÓD. DESCRIÇÃO 8145 SERRA MÁRMORE 1200W 127V</p>	<p>CÓD. DESCRIÇÃO 8447 SERRA MÁRMORE 1200W 127V</p>
 <p>BOMVINK</p>	 <p>BOMVINK</p>	 <p>BOMVINK</p>
<p>CÓD. DESCRIÇÃO 8825 SERRA TICO TICO 550W</p>	<p>CÓD. DESCRIÇÃO 8822 MAQUINA DE ACENTAR PISO BATERIA 21V</p>	<p>CÓD. DESCRIÇÃO 8256 SERRA CIRCULAR ELÉTRICA 127V 1100W</p>
 <p>BOMVINK</p>	 <p>BOMVINK</p>	 <p>BOMVINK</p>
<p>CÓD. DESCRIÇÃO 8820 MANDRIL APERTO RÁPIDO 1/2 (UNIVERSAL)</p>	<p>CÓD. DESCRIÇÃO 8820 MANDRIL APERTO RÁPIDO 08 A 10MM</p>	<p>CÓD. DESCRIÇÃO 8338 MOTOSERRA 8" A BATERIA 21V 8329 MOTOSERRA 6" A BATERIA 21V</p>

ULTRA
FERRAMENTAS



ULTRA
ATACADISTA

153

FERRAMENTAS E UTILIDADES



CÓD. 8873 **DESCRIÇÃO** PISTOLA DE PREGOS



CÓD. 8789 **DESCRIÇÃO** PISTOLA DE PREGOS KIT



CÓD. 8981 **DESCRIÇÃO** BOMBA PERIFÉRICA 1/2 HP - 127V
8982 BOMBA PERIFÉRICA 1/2 HP - 220V
8983 BOMBA PERIFÉRICA 1 HP - BIVOLT



CÓD. 8465 **DESCRIÇÃO** MOTOBOMBA PERIFÉRICA 1/2 HP 370W 220V
8464 MOTO BOMBA PERIFÉRICA 1/2 HP 370W 127V
8927 BOMBA PERIFÉRICA 1/2 HP BIVOLT



CÓD. 8146 **DESCRIÇÃO** SOPRADOR E ASPIRADOR ELÉTRICO 700W 127V



CÓD. 8252 **DESCRIÇÃO** LAVADORA DE ALTA PRESSÃO 127V



CÓD. 8841 **DESCRIÇÃO** SOPRADOR E ASPIRADOR TURBO MINI A BATERIA

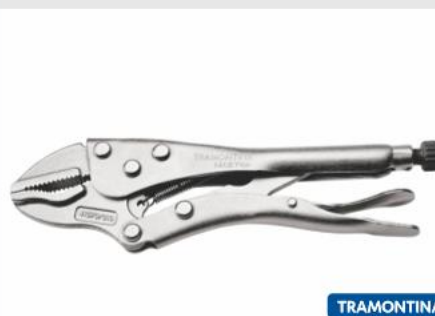

CÓD. 4680 **DESCRIÇÃO** ALICATE PRESSÃO 10" MORD TRIANGULO



CÓD. 3271 **DESCRIÇÃO** ALICATE PRESSÃO 10" PREMIUM



CÓD. 8332 **DESCRIÇÃO** ALICATE PRESSÃO 10" - 25MM



CÓD. 8160 **DESCRIÇÃO** ALICATE PRESSÃO MORD. RETO/CURVO 10V 10"



CÓD. 3342 **DESCRIÇÃO** CHAVE GRIFO / TUBO 10"
33433344 CHAVE GRIFO / TUBO 12"
33444615 CHAVE GRIFO / TUBO 14"
46154616 CHAVE GRIFO 08
46164617 CHAVE GRIFO 18
4617 CHAVE GRIFO 24



CÓD. 1541 **DESCRIÇÃO** ALICATE PRESSÃO CROMADO

















CÓD. 1544 **DESCRIÇÃO** CHAVE GRIFO 10"
1545 CHAVE GRIFO 12"
1546 CHAVE GRIFO 14"

















CÓD. 8259 **DESCRIÇÃO** CHAVE GRIFO 10"
8260 CHAVE GRIFO 12"
8559 CHAVE GRIFO 14"
8560 CHAVE GRIFO 18"

FERRAMENTAS E UTILIDADES

 <p style="text-align: right;">BOMVINK</p>	 <p style="text-align: right;">TRAMONTINA</p>	 <p style="text-align: right;">THOMPSON</p>																						
<table border="1"> <thead> <tr> <th>CÓD.</th> <th>DESCRIÇÃO</th> </tr> </thead> <tbody> <tr> <td>8107</td> <td>CHAVE INGLESA 8" AJUSTÁVEL</td> </tr> <tr> <td>8108</td> <td>CHAVE INGLESA 10" AJUSTÁVEL</td> </tr> <tr> <td>8109</td> <td>CHAVE INGLESA 12" AJUSTÁVEL</td> </tr> </tbody> </table>	CÓD.	DESCRIÇÃO	8107	CHAVE INGLESA 8" AJUSTÁVEL	8108	CHAVE INGLESA 10" AJUSTÁVEL	8109	CHAVE INGLESA 12" AJUSTÁVEL	<table border="1"> <thead> <tr> <th>CÓD.</th> <th>DESCRIÇÃO</th> </tr> </thead> <tbody> <tr> <td>6519</td> <td>CHAVE INGLESA 06" AJUSTÁVEL</td> </tr> <tr> <td>6520</td> <td>CHAVE INGLESA 10" AJUSTÁVEL</td> </tr> </tbody> </table>	CÓD.	DESCRIÇÃO	6519	CHAVE INGLESA 06" AJUSTÁVEL	6520	CHAVE INGLESA 10" AJUSTÁVEL	<table border="1"> <thead> <tr> <th>CÓD.</th> <th>DESCRIÇÃO</th> </tr> </thead> <tbody> <tr> <td>3335</td> <td>CHAVE INGLESA 08"</td> </tr> <tr> <td>3336</td> <td>CHAVE INGLESA 10"</td> </tr> <tr> <td>3337</td> <td>CHAVE INGLESA 12"</td> </tr> </tbody> </table>	CÓD.	DESCRIÇÃO	3335	CHAVE INGLESA 08"	3336	CHAVE INGLESA 10"	3337	CHAVE INGLESA 12"
CÓD.	DESCRIÇÃO																							
8107	CHAVE INGLESA 8" AJUSTÁVEL																							
8108	CHAVE INGLESA 10" AJUSTÁVEL																							
8109	CHAVE INGLESA 12" AJUSTÁVEL																							
CÓD.	DESCRIÇÃO																							
6519	CHAVE INGLESA 06" AJUSTÁVEL																							
6520	CHAVE INGLESA 10" AJUSTÁVEL																							
CÓD.	DESCRIÇÃO																							
3335	CHAVE INGLESA 08"																							
3336	CHAVE INGLESA 10"																							
3337	CHAVE INGLESA 12"																							
 <p style="text-align: right;">IRWIN</p>	 <p style="text-align: right;">OMEGA IMPORTADORA</p>	 <p style="text-align: right;">TRAMONTINA</p>																						
<table border="1"> <thead> <tr> <th>CÓD.</th> <th>DESCRIÇÃO</th> </tr> </thead> <tbody> <tr> <td>8162</td> <td>ALICATE BOMBA DÁGUA 10"</td> </tr> </tbody> </table>	CÓD.	DESCRIÇÃO	8162	ALICATE BOMBA DÁGUA 10"	<table border="1"> <thead> <tr> <th>CÓD.</th> <th>DESCRIÇÃO</th> </tr> </thead> <tbody> <tr> <td>5251</td> <td>ALICATE BOMBA DÁGUA 10"</td> </tr> </tbody> </table>	CÓD.	DESCRIÇÃO	5251	ALICATE BOMBA DÁGUA 10"	<table border="1"> <thead> <tr> <th>CÓD.</th> <th>DESCRIÇÃO</th> </tr> </thead> <tbody> <tr> <td>4679</td> <td>ALICATE BOMBA DÁGUA 10" FORJADO</td> </tr> </tbody> </table>	CÓD.	DESCRIÇÃO	4679	ALICATE BOMBA DÁGUA 10" FORJADO										
CÓD.	DESCRIÇÃO																							
8162	ALICATE BOMBA DÁGUA 10"																							
CÓD.	DESCRIÇÃO																							
5251	ALICATE BOMBA DÁGUA 10"																							
CÓD.	DESCRIÇÃO																							
4679	ALICATE BOMBA DÁGUA 10" FORJADO																							
 <p style="text-align: right;">THOMPSON</p>	 <p style="text-align: right;">TRAMONTINA</p>	 <p style="text-align: right;">IRWIN</p>																						
<table border="1"> <thead> <tr> <th>CÓD.</th> <th>DESCRIÇÃO</th> </tr> </thead> <tbody> <tr> <td>2370</td> <td>ALICATE CORTE DIAG. CROMO VANADIO 6"</td> </tr> <tr> <td>2369</td> <td>ALICATE CORTE DIAG. CROMO VANÁDIO PREMIUM</td> </tr> </tbody> </table>	CÓD.	DESCRIÇÃO	2370	ALICATE CORTE DIAG. CROMO VANADIO 6"	2369	ALICATE CORTE DIAG. CROMO VANÁDIO PREMIUM	<table border="1"> <thead> <tr> <th>CÓD.</th> <th>DESCRIÇÃO</th> </tr> </thead> <tbody> <tr> <td>4758</td> <td>ALICATE DE CORTE DIAGONAL 6" FORJADO</td> </tr> </tbody> </table>	CÓD.	DESCRIÇÃO	4758	ALICATE DE CORTE DIAGONAL 6" FORJADO	<table border="1"> <thead> <tr> <th>CÓD.</th> <th>DESCRIÇÃO</th> </tr> </thead> <tbody> <tr> <td>8163</td> <td>ALICATE DE CORTE DIAGONAL 6"</td> </tr> </tbody> </table>	CÓD.	DESCRIÇÃO	8163	ALICATE DE CORTE DIAGONAL 6"								
CÓD.	DESCRIÇÃO																							
2370	ALICATE CORTE DIAG. CROMO VANADIO 6"																							
2369	ALICATE CORTE DIAG. CROMO VANÁDIO PREMIUM																							
CÓD.	DESCRIÇÃO																							
4758	ALICATE DE CORTE DIAGONAL 6" FORJADO																							
CÓD.	DESCRIÇÃO																							
8163	ALICATE DE CORTE DIAGONAL 6"																							
 <p style="text-align: right;">prismatec</p>	 <p style="text-align: right;">BOMVINK</p>	 <p style="text-align: right;">OMEGA IMPORTADORA</p>																						
<table border="1"> <thead> <tr> <th>CÓD.</th> <th>DESCRIÇÃO</th> </tr> </thead> <tbody> <tr> <td>3178</td> <td>ALICATE CORTE DIAGONAL 6"</td> </tr> </tbody> </table>	CÓD.	DESCRIÇÃO	3178	ALICATE CORTE DIAGONAL 6"	<table border="1"> <thead> <tr> <th>CÓD.</th> <th>DESCRIÇÃO</th> </tr> </thead> <tbody> <tr> <td>8150</td> <td>ALICATE CORTE DIAGONAL 6"</td> </tr> </tbody> </table>	CÓD.	DESCRIÇÃO	8150	ALICATE CORTE DIAGONAL 6"	<table border="1"> <thead> <tr> <th>CÓD.</th> <th>DESCRIÇÃO</th> </tr> </thead> <tbody> <tr> <td>1073</td> <td>ALICATE CORTE DIAGONAL</td> </tr> </tbody> </table>	CÓD.	DESCRIÇÃO	1073	ALICATE CORTE DIAGONAL										
CÓD.	DESCRIÇÃO																							
3178	ALICATE CORTE DIAGONAL 6"																							
CÓD.	DESCRIÇÃO																							
8150	ALICATE CORTE DIAGONAL 6"																							
CÓD.	DESCRIÇÃO																							
1073	ALICATE CORTE DIAGONAL																							
 <p style="text-align: right;">OMEGA IMPORTADORA</p>	 <p style="text-align: right;">prismatec</p>	 <p style="text-align: right;">IRWIN</p>																						
<table border="1"> <thead> <tr> <th>CÓD.</th> <th>DESCRIÇÃO</th> </tr> </thead> <tbody> <tr> <td>1074</td> <td>ALICATE UNIVERSAL ENCARTELADO</td> </tr> </tbody> </table>	CÓD.	DESCRIÇÃO	1074	ALICATE UNIVERSAL ENCARTELADO	<table border="1"> <thead> <tr> <th>CÓD.</th> <th>DESCRIÇÃO</th> </tr> </thead> <tbody> <tr> <td>7177</td> <td>ALICATE UNIVERSAL ENCARTELADO</td> </tr> </tbody> </table>	CÓD.	DESCRIÇÃO	7177	ALICATE UNIVERSAL ENCARTELADO	<table border="1"> <thead> <tr> <th>CÓD.</th> <th>DESCRIÇÃO</th> </tr> </thead> <tbody> <tr> <td>8159</td> <td>ALICATE UNIVERSAL ISOLADO 1000V 8" PROFISSIONAL</td> </tr> </tbody> </table>	CÓD.	DESCRIÇÃO	8159	ALICATE UNIVERSAL ISOLADO 1000V 8" PROFISSIONAL										
CÓD.	DESCRIÇÃO																							
1074	ALICATE UNIVERSAL ENCARTELADO																							
CÓD.	DESCRIÇÃO																							
7177	ALICATE UNIVERSAL ENCARTELADO																							
CÓD.	DESCRIÇÃO																							
8159	ALICATE UNIVERSAL ISOLADO 1000V 8" PROFISSIONAL																							

FERRAMENTAS E UTILIDADES

 <p>TRAMONTINA</p>	 <p>THOMPSON</p>	 <p>IRWIN</p>
<p>CÓD. DESCRIÇÃO 4750 ALICATE UNIVERSAL 8" FORJADO ISOL. 1000V</p>	<p>CÓD. DESCRIÇÃO 2372 ALICATE UNIVERSAL POLIDO 10" PREMIUM 2373 ALICATE UNIVERSAL CROMO VANÁDIO 10"</p>	<p>CÓD. DESCRIÇÃO 8165 ALICATE UNIVERSAL 8"</p>
 <p>BOMVINK</p>	 <p>OMEGA IMPORTADORA</p>	 <p>TRAMONTINA</p>
<p>CÓD. DESCRIÇÃO 8248 ALICATE UNIVERSAL 8" CROMO VANÁDIO</p>	<p>CÓD. DESCRIÇÃO 1072 ALICATE BICO LONGO</p>	<p>CÓD. DESCRIÇÃO 4678 ALICATE BICO 6" MEIA CANA FORJADO</p>
 <p>primatec</p>	 <p>IRWIN</p>	 <p>THOMPSON</p>
<p>CÓD. DESCRIÇÃO 7179 ALICATE BICO RETO 6"</p>	<p>CÓD. DESCRIÇÃO 8161 ALICATE BICO RETO 6"</p>	<p>CÓD. DESCRIÇÃO 2368 ALICATE BICO RETO CROMO VANÁDIO 6" PRE. 2367 ALICATE BICO RETO POLIDO 6" PRE.</p>
 <p>BOMVINK</p>	 <p>IRWIN</p>	 <p>S&S São Romão De Profissional para Profissional</p>
<p>CÓD. DESCRIÇÃO 8149 ALICATE BICO RETO 6"</p>	<p>CÓD. DESCRIÇÃO 8158 TORQUES ARMADOR 14"</p>	<p>CÓD. DESCRIÇÃO 7154 TORQUES ARMADOR 10"</p>
 <p>TRAMONTINA</p>	 <p>S&S São Romão De Profissional para Profissional</p>	 <p>THOMPSON</p>
<p>CÓD. DESCRIÇÃO 4759 TORQUES ARMADOR 12" FORJADA</p>	<p>CÓD. DESCRIÇÃO 2817 TORQUES ARMADOR 12" PREMIUM AZUL</p>	<p>CÓD. DESCRIÇÃO 7848 TORQUES ARMADOR 12"</p>

FERRAMENTAS E UTILIDADES

 <p>FERRAMENTAS São Romão <small>Os Profissionais para Profissionais</small></p>	 <p>FERRAMENTAS São Romão <small>Os Profissionais para Profissionais</small></p>	 <p>FERRAMENTAS São Romão <small>Os Profissionais para Profissionais</small></p>
<p>CÓD. DESCRIÇÃO 1017 TORQUES ARMADOR 12" VERDE</p>	<p>CÓD. DESCRIÇÃO 1014 TORQUES ARMADOR 14" - PREMIUM</p>	<p>CÓD. DESCRIÇÃO 6404 TORQUES ARMADOR 14" VERDE</p>
 <p>FERRAMENTAS São Romão <small>Os Profissionais para Profissionais</small></p>	 <p>FERRAMENTAS São Romão <small>Os Profissionais para Profissionais</small></p>	 <p>Gortag</p>
<p>CÓD. DESCRIÇÃO 4883 TORQUES AZULEJISTA 05 1015 TORQUES AZULEJISTA 06</p>	<p>CÓD. DESCRIÇÃO 4884 TORQUES CARPINTEIRO 07 1016 TORQUES CARPINTEIRO 08</p>	<p>CÓD. DESCRIÇÃO 1471 ALICATE PARA NIVELAMENTO</p>
 <p>metasul</p>	 <p>BOMVINK</p>	 <p>THOMPSON</p>
<p>CÓD. DESCRIÇÃO 3269 ALICATE PARA NIVELAMENTO</p>	<p>CÓD. DESCRIÇÃO 8454 ALICATE PARA NIVELAMENTO</p>	<p>CÓD. DESCRIÇÃO 6636 ALICATE REBITADOR CABECA GIRATORIA 360</p>
 <p>THOMPSON</p>	 <p>MEGA <small>IMPORTADORA</small></p>	 <p>BOMVINK</p>
<p>CÓD. DESCRIÇÃO 3334 ALICATE REBITADOR 4 BICOS REBMAX</p>	<p>CÓD. DESCRIÇÃO 1075 ALICATE REBITADOR</p>	<p>CÓD. DESCRIÇÃO 8110 ALICATE REBITADOR 10"</p>
 <p>IRWIN</p>	 <p>BOMVINK</p>	 <p>MEGA <small>IMPORTADORA</small></p>
<p>CÓD. DESCRIÇÃO 8164 ALICATE REBITADOR MANUAL R100</p>	<p>CÓD. DESCRIÇÃO 8112 ALICATE REBITADOR PROFISSIONAL ALAVANCA</p>	<p>CÓD. DESCRIÇÃO 1202 APLICADOR DE SILICONE</p>

FERRAMENTAS E UTILIDADES



THOMPSON

CÓD. 1936
 DESCRIÇÃO
 APLICADOR DE SILICONE 9"



TEK BOND

CÓD. 4555
 DESCRIÇÃO
 APLICADOR DE SILICONE TEK BOND



CANAÃ

CÓD. 7305
 DESCRIÇÃO
 ARCO DE SERRA FIXO CANAÃ



THOMPSON

CÓD. 5114
 DESCRIÇÃO
 ARCO DE SERRA FIXO PREMIUM P-1000



THOMPSON

CÓD. 5115
 DESCRIÇÃO
 ARCO DE SERRA MONOBLOCO MAC 2100



OMEGA
 IMPORTADORA

CÓD. 1077
 DESCRIÇÃO
 ARCO DE SERRA REGULÁVEL



THOMPSON

CÓD. 5116
 DESCRIÇÃO
 ARCO DE SERRA REG CABO VERMELHO MAC 2000



TRAMONTINA

CÓD. 4677
 DESCRIÇÃO
 ARCO DE SERRA FIXO TRAMONTINA



METASUL

CÓD. 3091
 DESCRIÇÃO
 ARCO DE SERRA FIXO AMARELO METASUL



OMEGA
 IMPORTADORA

CÓD. 1076
 DESCRIÇÃO
 ARCO DE SERRA FIXO



THOMPSON

CÓD. 4069
 DESCRIÇÃO
 ARCO DE SERRA REGULÁVEL PREM. AJUSTÁVEL



BOMVINK

CÓD. 8821
 DESCRIÇÃO
 ARCO DE SERRA REGULÁVEL



THOMPSON

CÓD. 7997
 DESCRIÇÃO
 ARCO DE SERRA REGULÁVEL POP



ULTRA
 FERRAMENTAS

CÓD. 7997
 DESCRIÇÃO
 ARCO DE SERRA REGULÁVEL

CÓD. 7032
 DESCRIÇÃO
 ARCO DE SERRA FIXO



IRWIN

CÓD. 8847
 DESCRIÇÃO
 SERRA MANUAL BIMET. UNIQUE 18D IRWIN

CÓD. 8846
 DESCRIÇÃO
 SERRA MANUAL BIMET. UNIQUE 24D IRWIN

FERRAMENTAS E UTILIDADES



Starrett

CÓD.	DESCRIÇÃO
4459	SERRA MANUAL BIMET. UNIQUE 18D STARRETT
2821	SERRA MANUAL BIMET. UNIQUE 24D STARRETT



prismatec

CÓD.	DESCRIÇÃO
7181	SERRA MANUAL AÇO CARBONO 24D



THOMPSON

CÓD.	DESCRIÇÃO
6527	SERRA MANUAL BIMET. UNIQUE 18D
6798	SERRA MANUAL BIMET. UNIQUE 24D



THOMPSON

CÓD.	DESCRIÇÃO
4905	SERRA MANUAL AÇO CARBONO 18D
3365	SERRA MANUAL AÇO CARBONO 24D



CANAÃ

CÓD.	DESCRIÇÃO
7371	ARCO DE SERRA MINI PEQUENINO CANAA



THOMPSON

CÓD.	DESCRIÇÃO
7326	SERRA COPO JOGO 5 PECAS THOMPSON



OMEGA
IMPORTADORA

CÓD.	DESCRIÇÃO
1550	SERRA COPO JOGO 11 PEÇAS C/ ESTOJO



Famastil

CÓD.	DESCRIÇÃO
3851	SERROTE PODA CURVO 12" CABO DE MADEIRA



THOMPSON

CÓD.	DESCRIÇÃO
8445	SERROTE PODA 12"



BOMVINK

CÓD.	DESCRIÇÃO
8111	SERROTE PODA DOBRÁVEL 7"



THOMPSON

CÓD.	DESCRIÇÃO
7221	SERROTE PARA GESSO



FOXLUX

CÓD.	DESCRIÇÃO
3849	SERROTE 20" CABO MADEIRA



IRWIN

CÓD.	DESCRIÇÃO
8224	SERROTE 20" BI MATERIAL 500MM
8225	SERROTE 22" BI MATERIAL 500MM



TRAMONTINA

CÓD.	DESCRIÇÃO
4675	SERROTE 20" PROFESSIONAL
4676	SERROTE 22" PROFESSIONAL



THOMPSON

CÓD.	DESCRIÇÃO
4620	SERROTE 20" CAVALITO PROFESSIONAL
4621	SERROTE 22" CAVALITO PROFESSIONAL

FERRAMENTAS E UTILIDADES



THOMPSON

CÓD.	DESCRIÇÃO
776	SERROTE 20" THOMPSON
777	SERROTE 22" THOMPSON



ULTRA
FERRAMENTAS

CÓD.	DESCRIÇÃO
7008	SERROTE 20 POLEGADAS BRONZE
7009	SERROTE 22 POLEGADAS BRONZE



BOMVINK

CÓD.	DESCRIÇÃO
8261	SERROTE 22"



TRAMONTINA

CÓD.	DESCRIÇÃO
6322	ESTILETE RETRATIL 6 CORPO DUPLA INJECAO



THOMPSON

CÓD.	DESCRIÇÃO
5121	ESTILETE 18MM EMBORRACHADO PROFISSIONAL



THOMPSON

CÓD.	DESCRIÇÃO
1922	ESTILETE ESTREITO PREMIUM 18 MM



TRAMONTINA

CÓD.	DESCRIÇÃO
6321	ESTILETE RETRATIL 6 CORPO INJETADO



PRISMA TEC

CÓD.	DESCRIÇÃO
7180	LAMINA P/ ESTILETE 18MM C/ 10PCS



THOMPSON

CÓD.	DESCRIÇÃO
5122	LAMINA P/ ESTILETE 18MM C/ 10PCS



BOMVINK

CÓD.	DESCRIÇÃO
8119	KIT TESOURA 3 PEÇAS 5.1/2-7.1/2-8.1/2



THOMPSON

CÓD.	DESCRIÇÃO
7323	TESOURA USO GERAL 8" - 20CM THOMPSON



THOMPSON

CÓD.	DESCRIÇÃO
7319	TESOURA CORTA VERGALHAO 14 THOMPSON
7320	TESOURA CORTA VERGALHAO 18 THOMPSON
7327	TESOURA CORTA VERGALHAO 24 THOMPSON
7321	TESOURA CORTA VERGALHAO 30 THOMPSON
7322	TESOURA CORTA VERGALHAO 36 THOMPSON



THOMPSON

CÓD.	DESCRIÇÃO
1933	PEDRA DE AFIAIR RETANGULAR DUAS FACES 8"



BOMVINK

CÓD.	DESCRIÇÃO
8415	AFIADOR AMOLADOR DE FACAS E TESOURAS



BOMVINK

CÓD.	DESCRIÇÃO
8441	JOGO DE LIMA COM CABO

FERRAMENTAS E UTILIDADES



CÓD.	DESCRIÇÃO
3782	TRENA 5M X16MM T34



CÓD.	DESCRIÇÃO
8226	TRENA 03 METROS
8227	TRENA 05 METROS
8228	TRENA 08 METROS



CÓD.	DESCRIÇÃO
7510	TRENA 03M X 16MM COLOR COM TRAVA



CÓD.	DESCRIÇÃO
4747	TRENA 03M FITA DE AÇO AMARELA
47484749	TRENA 05M FITA DE AÇO AMARELA
4749	TRENA 7,5M FITA DE AÇO AMARELA



CÓD.	DESCRIÇÃO
4318	TRENA 03M X 16MM EMBORRACHADA
4319432	TRENA 05M X 19MM EMBORRACHADA
4321	TRENA 10M X 25MM EMBORRACHADA



CÓD.	DESCRIÇÃO
7324	TRENA EMBORRACHADA C/TRAVA IMA 5M X 19MM
761	TRENA EMBORRACHADA COM TRAVA IMA 7,5X25MM



CÓD.	DESCRIÇÃO
2366	TRENA COLOR C/ TRAVA - 05 M X 16 MM
2397898	TRENA COLOR C/ TRAVA - 05 M X 19 MM
8984	TRENA 03MX13MM COLOR C/ TRAVA



CÓD.	DESCRIÇÃO
3361	TRENA EMBORRACHADA 10M X 25MM C/IMA



CÓD.	DESCRIÇÃO
2693	TRENA EMBORRACHADA 03 M X 16 MM
1083158	TRENA EMBORRACHADA 05 M X 19 MM
1580	TRENA EMBORRACHADA 05 M X 25 MM



CÓD.	DESCRIÇÃO
8133	TRENA 03X19MM COM TRAVA
81348135	TRENA 05X19MM COM TRAVA
8135	TRENA 7,5X25MM COM TRAVA



CÓD.	DESCRIÇÃO
8251	TRENA EMBORRACHADA 5MX25MM MAG. C/ TRAVA



CÓD.	DESCRIÇÃO
8268	TRENA A LASER 40M



CÓD.	DESCRIÇÃO
1803	TRENA 20 M FIBRA FECHADA



CÓD.	DESCRIÇÃO
8574	TRENA 100M FIBRA ABERTA



CÓD.	DESCRIÇÃO
8136	TRENA 20M FIBRA FECHADA
8137	TRENA 30M FIBRA FECHADA

FERRAMENTAS E UTILIDADES



CÓD. DESCRIÇÃO
5581 TRENA 30M FIBRA ABERTA



BOMVINK

CÓD. DESCRIÇÃO
8310 TRENA 50M FIBRA ABERTA



THOMPSON

CÓD. DESCRIÇÃO
1804 TRENA 30 M FIBRA ABERTA
1805 TRENA 50 M FIBRA ABERTA



MAX
FERRAMENTAS

CÓD. DESCRIÇÃO
7004 METRO NYLON 1M



BOMVINK

CÓD. DESCRIÇÃO
8597 KIT FITA MÉTRICA COM 2 FITAS 150CM



OMEGA
IMPORTADORA

CÓD. DESCRIÇÃO
1081 NÍVEL ALUMÍNIO 3 BOLHAS



THOMPSON

CÓD. DESCRIÇÃO
773 NÍVEL MADEIRA 12" (30 CM)
5354 NÍVEL MADEIRA 10" (25CM)



THOMPSON

CÓD. DESCRIÇÃO
3353 NÍVEL BASE MAGNETICA 12" (30CM)
3354 NÍVEL BASE MAGNETICA 14" (35CM)



BOMVINK

CÓD. DESCRIÇÃO
8420 NÍVEL PVC 3 BOLHAS 30 CM COM RÉGUA
8541 NÍVEL PVC 3 BOLHAS 50 CM COM RÉGUA



THOMPSON

CÓD. DESCRIÇÃO
3351 NÍVEL DE ALUMÍNIO 2 BOLHAS 12" (30CM)
3352 NÍVEL DE ALUMÍNIO 2 BOLHAS 14" (35CM)



CORTAG

CÓD. DESCRIÇÃO
3500 NÍVEL DE ALUMÍNIO 14" 35CM
3501 NÍVEL DE ALUMÍNIO 16" 40CM
3502 NÍVEL DE ALUMÍNIO 18" 45CM
3503 NÍVEL DE ALUMÍNIO 20" 50CM
3504 NÍVEL DE ALUMÍNIO 24" 60CM
3505 NÍVEL DE ALUMÍNIO 30" 75CM
3506 NÍVEL DE ALUMÍNIO 40" 100CM
3507 NÍVEL DE ALUMÍNIO 47" 120CM



TRAMONTINA

CÓD. DESCRIÇÃO
7067 NÍVEL 12" 30,5 CM POLIMERO DE ENGENHARIA
7068 NÍVEL 18" 45,5 CM POLIMERO DE ENGENHARIA
7069 NÍVEL 24" 61 CM POLIMERO DE ENGENHARIA



THOMPSON

CÓD. DESCRIÇÃO
3355 NÍVEL PVC 12" 3 BOLHAS (30CM)



TRAMONTINA

CÓD. DESCRIÇÃO
6351 NÍVEL BASE MAGNETICA 12" DE ALUMÍNIO



THOMPSON

CÓD. DESCRIÇÃO
3352 NÍVEL DE ALUMÍNIO 3 BOLHAS 14

FERRAMENTAS E UTILIDADES



CÓD. DESCRIÇÃO
 1302 CAIXA FERRAMENTAS POLIPROPILENO 12,5"
 1303 CAIXA FERRAMENTAS POLIPROPILENO 16"
 1304 CAIXA FERRAMENTAS POLIPROPILENO 19,5"



TRAMONTINA

CÓD. DESCRIÇÃO
 5342 CAIXA FERRAMENTAS 13" BANDEJA REMOVIVEL
 5343 CAIXA FER 20" BANDEJA REMOV TRAMONTINA
 5344 CAIXA FER 17" BANDEJA REMOV TRAMONTINA



IRWIN

CÓD. DESCRIÇÃO
 8166 BOLSA FERRAMENTAS 12"



BOMVINK

CÓD. DESCRIÇÃO
 8122 JOGO CHAVE CRV 40 PEÇAS



BOMVINK

CÓD. DESCRIÇÃO
 8121 JOGO CHAVE CATRACA SOQUETE 46 PEÇAS



BOMVINK

CÓD. DESCRIÇÃO
 8120 JOGO CHAVE ARTICULÁVEL 41 PEÇAS



BOMVINK

CÓD. DESCRIÇÃO
 8123 JOGO DE FERRAMENTAS BÁSICAS 126 PEÇAS



BOMVINK

CÓD. DESCRIÇÃO
 8498 JOGO DE FERRAMENTAS BÁSICAS 27 PEÇAS



THOMPSON

CÓD. DESCRIÇÃO
 8092 JOGO CHAVE SOQUETE 1/4 CR-V C/ 40 PEÇAS



THOMPSON

CÓD. DESCRIÇÃO
 8093 JOGO CHAVE SOQUETE 3/8 CR-V C/ 11 PEÇAS



MEGA
 IMPORTADORA

CÓD. DESCRIÇÃO
 1549 JOGO CHAVE TORX



MEGA
 IMPORTADORA

CÓD. DESCRIÇÃO
 1543 JOGO DE CHAVE ALLEN



THOMPSON

CÓD. DESCRIÇÃO
 7325 JOGO CHAVE ALLEN 1,5 A 10 C/10 PCS



BOMVINK

CÓD. DESCRIÇÃO
 8118 JOGO CHAVE ALLEN 1.5MM 10 COM 10



BOMVINK

CÓD. DESCRIÇÃO
 8117 JOGO DE CHAVE TORX 09 PEÇAS

FERRAMENTAS E UTILIDADES



TRAMONTINA

CÓD.	DESCRIÇÃO
4681	JOGO CHAVE FIXA 8 PECAS TRAMONTINA



TRAMONTINA

CÓD.	DESCRIÇÃO
6309	CHAVE BIELA 8MM
63106311	CHAVE BIELA 9 MM
63116312	CHAVE BIELA 10MM
63126313	CHAVE BIELA 11MM
63136314	CHAVE BIELA 12MM
63146315	CHAVE BIELA 13MM
63156316	CHAVE BIELA 14MM
63166317	CHAVE BIELA 15MM
63176318	CHAVE BIELA 16MM
63186319	CHAVE BIELA 17MM
63196320	CHAVE BIELA 18MM
6320	CHAVE BIELA 19MM



TRAMONTINA

CÓD.	DESCRIÇÃO
4682	CHAVE COMBINADA 08MM
46834684	CHAVE COMBINADA 09MM
46844685	CHAVE COMBINADA 10MM
46854686	CHAVE COMBINADA 11MM
46864687	CHAVE COMBINADA 12MM
46874688	CHAVE COMBINADA 13MM
46884689	CHAVE COMBINADA 14MM
46894690	CHAVE COMBINADA 15MM
46904691	CHAVE COMBINADA 16MM
46914692	CHAVE COMBINADA 17MM
46924693	CHAVE COMBINADA 18MM
46934694	CHAVE COMBINADA 19MM
46944695	CHAVE COMBINADA 20MM
46954975	CHAVE COMBINADA 21MM
49754976	CHAVE COMBINADA 22MM
49764696	CHAVE COMBINADA 23MM
46964697	CHAVE COMBINADA 24MM
46974977	CHAVE COMBINADA 25MM
49774698	CHAVE COMBINADA 26MM
46984699	CHAVE COMBINADA 27MM
46994700	CHAVE COMBINADA 28MM
47004701	CHAVE COMBINADA 30MM
4701	CHAVE COMBINADA 32MM



BOMVINK

CÓD.	DESCRIÇÃO
8469	CHAVE COMBINADA 06MM
84708471	CHAVE COMBINADA 07MM
84718472	CHAVE COMBINADA 08MM
84728473	CHAVE COMBINADA 09MM
84738474	CHAVE COMBINADA 10MM
84748475	CHAVE COMBINADA 11MM
84758476	CHAVE COMBINADA 12MM
84768477	CHAVE COMBINADA 13MM
84778478	CHAVE COMBINADA 14MM
84788479	CHAVE COMBINADA 15MM
84798480	CHAVE COMBINADA 16MM
84808481	CHAVE COMBINADA 17MM
8481	CHAVE COMBINADA 18MM



TRAMONTINA

CÓD.	DESCRIÇÃO
6301	CHAVE FIXA 8X9 MM
63026303	CHAVE FIXA 10X11 MM
63036304	CHAVE FIXA 12X13 MM
63046305	CHAVE FIXA 16X17 MM
63056306	CHAVE FIXA 18X19 MM
63066307	CHAVE FIXA 20X22 MM
63076308	CHAVE FIXA 21X23 MM
63086352	CHAVE FIXA 24X26 MM
6352	CHAVE FIXA 14X15 MM



BOMVINK

CÓD.	DESCRIÇÃO
8352	CHAVE MÁGICA PARA PORCAS E PARAFUSOS 8" AJUSTÁVEL



BOMVINK

CÓD.	DESCRIÇÃO
8104	CHAVE SOQUETE NINJA COM 3 PONTAS 10,11,13MM
81058084	CHAVE SOQUETE NINJA COM 3 PONTAS 08,10,12MM
8108	CHAVE SOQUETE NINJA COM 3 PONTAS 12,14,17MM



Bestfer

CÓD.	DESCRIÇÃO
8045	JOGO DE CHAVES FIXA 08 PEÇAS
80448043	JOGO DE CHAVES FIXA 06 PEÇAS
80438042	JOGO DE CHAVES COMB. 06 PEÇAS
8042	JOGO DE CHAVES COMB. 12 PEÇAS



BOMVINK

CÓD.	DESCRIÇÃO
8412	CHAVE DE RODA E BOCA 10 EM 1 8 A 17 (BICICLETA)



THOMPSON

CÓD.	DESCRIÇÃO
8091	CHAVE DE RODA CRUZETA 17-19-21-23



Bestfer

CÓD.	DESCRIÇÃO
7818	CHAVE PARA MANDRIL 13MM - 1/2POL



TRAMONTINA

CÓD.	DESCRIÇÃO
4702	JOGO CHAVE COMBINADA 08 PECAS TRAMONTINA



BOMVINK

CÓD.	DESCRIÇÃO
8106	CHAVE DE BOCA FIXA DUPLA 8 A 22MM

FERRAMENTAS E UTILIDADES



THOMPSON

CÓD.	DESCRIÇÃO
1899	CH FEN. CB A 1/8 X 3 CV C/PI PROF.
19001901	CH FEN. CB B 1/8 X 4 CV C/PI PROF.
19011902	CH FEN. CB C 1/8 X 5 CV C/PI PROF.
19021903	CH FEN. CB D 3/16 X 3 CV C/PI PROF.
19031904	CH FEN. CB E 3/16 X 5 CV C/PI PROF.
19041906	CH FEN. CB G 3/16 X 6 CV C/PI PROF.
19061907	CH FEN. CB J 1/4 X 6 CV C/PI PROF.
19071908	CH FEN. CB K 1/4 X 8 CV C/PI PROF.
19081905	CH FEN. CB VERDE L 5/16X6 CV C/ PI PROF
19051909	CH FEN. CB L 5/16 X 6 CV C/PI PROF.
19091910	CH FEN. CB M 5/16 X 8 CV C/PI PROF.
19101911	CH FEN. CB N 5/16 X 10 CV C/PI PROF.
19111912	CH FEN. CB O 3/8 X 6 CV C/PI PROF.
19121913	CH FEN. CB P 3/8 X 8 CV C/PI PROF.
19131914	CH FEN. CB Q 3/8 X 10 CV C/PI PROF.
19141915	CH PHILLIPS A 1/8 X 3 CV C/ PI PROF. CB
19151916	CH PHILLIPS B 3/16 X 3 CV C/ PI PROF. CB
19161917	CH PHILLIPS C 3/16 X 4 CV C/ PI PROF. CB
19171918	CH PHILLIPS E 1/4 X 6 CV C/ PI PROF. CB
19181919	CH PHILLIPS F 5/16 X 6 CV C/ PI PROF. CB
19194981	CH PHILLIPS G 3/8 X 8 CV C/ PI PROF. CB
49814982	CH PHILIPS 1/8X4 CV C/ PI PROF CB VERDE
49824983	CH PHILIPS 1/8X5 CV C/ PI PROF CB VERDE
49834984	CH PHILIPS 3/16X5 CV C/ PI PROF CB VERDE
49844985	CH PHILIPS 3/16X6 CV C/ PI PROF CB VERDE
49854986	CH PHILIPS 1/4X5 CV C/ PI PROF CB VERDE
49864987	CH PHILIPS 1/4X8 CV C/ PI PROF CB VERDE
49874988	CH PHILIPS 5/16X8 CV C/ PI PROF CB VERDE
49884989	CH PHILIPS 5/16X10 CV C/ PI PROF CB VERDE
49894990	CH PHILIPS 3/8X6 CV C/ PI PROF CB VERDE
4990	CH PHILIPS 3/8X10 CV C/ PI PROF CB VERDE



TRAMONTINA

CÓD.	DESCRIÇÃO
4720	CHAVE FENDA 1/4X4 - TRAMONTINA
47214722	CHAVE FENDA 1/4X5 - TRAMONTINA
47224723	CHAVE FENDA 1/4X6 - TRAMONTINA
47234712	CHAVE FENDA 1/4X8 - TRAMONTINA
47124713	CHAVE FENDA 1/8X3 - TRAMONTINA
47134714	CHAVE FENDA 1/8X4 - TRAMONTINA
47144715	CHAVE FENDA 1/8X5 - TRAMONTINA
47154716	CHAVE FENDA 1/8X6 - TRAMONTINA
47164717	CHAVE FENDA 3/16X3 - TRAMONTINA
47174718	CHAVE FENDA 3/16X4 - TRAMONTINA
47184719	CHAVE FENDA 3/16X5 - TRAMONTINA
47194726	CHAVE FENDA 3/16X6 - TRAMONTINA
47264727	CHAVE FENDA 3/8X6 - TRAMONTINA
47274724	CHAVE FENDA 3/8X8 - TRAMONTINA
47244725	CHAVE FENDA 5/16X6 - TRAMONTINA
4725	CHAVE FENDA 5/16X8 - TRAMONTINA

TRAMONTINA



CÓD.	DESCRIÇÃO
4737	CHAVE PHILIPS 1/4X4 TRAMONTINA
47364738	CHAVE PHILIPS 1/4X5 TRAMONTINA
47384739	CHAVE PHILIPS 1/4X6 TRAMONTINA
47394729	CHAVE PHILIPS 1/4X8 TRAMONTINA
47294728	CHAVE PHILIPS 1/8X3 TRAMONTINA
47284730	CHAVE PHILIPS 1/8X4 TRAMONTINA
47304731	CHAVE PHILIPS 1/8X5 TRAMONTINA
47314733	CHAVE PHILIPS 1/8X6 TRAMONTINA
47334734	CHAVE PHILIPS 3/16X3 TRAMONTINA
47344732	CHAVE PHILIPS 3/16X4 TRAMONTINA
47324735	CHAVE PHILIPS 3/16X5 TRAMONTINA
47354742	CHAVE PHILIPS 3/16X6 TRAMONTINA
47424740	CHAVE PHILIPS 3/8X8 TRAMONTINA
47404741	CHAVE PHILIPS 5/16X6 TRAMONTINA
4741	CHAVE PHILIPS 5/16X8 TRAMONTINA



BOMVINK

CÓD.	DESCRIÇÃO
8818	KIT CHAVES TOCO FENDA/PHILIPS (2UNID.)



BOMVINK

CÓD.	DESCRIÇÃO
8115	CONJ. DE CHAVES DE FENDA PHILIPS + TESTE 5 PEÇAS



JOMARCA
PRODUTOS DE QUALIDADE

CÓD.	DESCRIÇÃO
3923	CHAVE PHILIPS 1/4X4
39243925	CHAVE PHILIPS 1/4X5
39253926	CHAVE PHILIPS 1/4X6
39263927	CHAVE PHILIPS 1/4X8
39273912	CHAVE PHILIPS 1/4X10
39123913	CHAVE PHILIPS 1/8X3
39133914	CHAVE PHILIPS 1/8X4
39143915	CHAVE PHILIPS 1/8X5
39153916	CHAVE PHILIPS 1/8X6
39163917	CHAVE PHILIPS 1/8X8
39173918	CHAVE PHILIPS 3/16X3
39183919	CHAVE PHILIPS 3/16X4
39193920	CHAVE PHILIPS 3/16X5
39203921	CHAVE PHILIPS 3/16X6
39213922	CHAVE PHILIPS 3/16X8
39223928	CHAVE PHILIPS 3/16X10
39283929	CHAVE PHILIPS 5/16X6
39293930	CHAVE PHILIPS 5/16X8
3930	CHAVE PHILIPS 5/16X10



JOMARCA
PRODUTOS DE QUALIDADE

CÓD.	DESCRIÇÃO
3904	CHAVE FENDA RETA 1/4X4
39053906	CHAVE FENDA RETA 1/4X5
39063907	CHAVE FENDA RETA 1/4X6
39073908	CHAVE FENDA RETA 1/4X8
39083895	CHAVE FENDA RETA 1/4X10
38953896	CHAVE FENDA RETA 1/8X4
38963897	CHAVE FENDA RETA 1/8X5
38973898	CHAVE FENDA RETA 1/8X6
38983899	CHAVE FENDA RETA 1/8X8
38993900	CHAVE FENDA RETA 3/16X4
39003901	CHAVE FENDA RETA 3/16X5
39013902	CHAVE FENDA RETA 3/16X6
39023903	CHAVE FENDA RETA 3/16X8
39033909	CHAVE FENDA RETA 3/16X10
39093910	CHAVE FENDA RETA 5/16X6
39103911	CHAVE FENDA RETA 5/16X8
3911	CHAVE FENDA RETA 5/16X10



BOMVINK

CÓD.	DESCRIÇÃO
8334	KIT 31 CHAVES DE PRECISÃO



JOMARCA
PRODUTOS DE QUALIDADE

CÓD.	DESCRIÇÃO
3931	CHAVE PHILIPS TOCO 3/16



TRAMONTINA

CÓD.	DESCRIÇÃO
4744	JOGO CHAVE FENDA/PHILIPS 7 PEÇAS



BOMVINK

CÓD.	DESCRIÇÃO
8788	JOGO CHAVE FENDA/PHILIPS 8 EM 1 COM LED

FERRAMENTAS E UTILIDADES



TRAMONTINA

CÓD. DESCRIÇÃO
4743 JOGO CHAVE FENDA 6 PCS C/SUP. PAR.



MEGA IMPORTADORA

CÓD. DESCRIÇÃO
1547 JOGO CHAVE FENDA/PHILIPS MEGA IMPORTADORA



BOMVINK

CÓD. DESCRIÇÃO
8250 KIT CHAVE DE FENDA/PHILIPS C/ 6 PONTAS DUPLAS



BOMVINK

CÓD. DESCRIÇÃO
8114 KIT PONTAS BITS COM CHAVES 12 PEÇAS



BOMVINK

CÓD. DESCRIÇÃO
8440 CHAVE DE FENDA COM CATRACA 8 EM 1



CÓD. DESCRIÇÃO
7817 KIT PONTEIRA BITS 10 PEÇAS PH2 X PH2 X 65MM



BOMVINK

CÓD. DESCRIÇÃO
8249 KIT CHAVES DE PRECISÃO COM 31 CHAVES



BOMVINK

CÓD. DESCRIÇÃO
8152 JOGO DE CHAVE CANHÃO COM 7 PEÇAS 5 A 12MM



BOMVINK

CÓD. DESCRIÇÃO
8483 KIT CABO EXTENSOR COM BITS



BOMVINK

CÓD. DESCRIÇÃO
8357 KIT FERRAM. PRIMEIROS SOCORROS DE CICLISTA

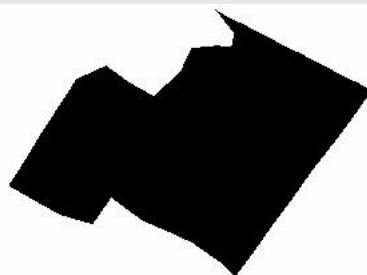

BOMVINK

CÓD. DESCRIÇÃO
8350 MARTELO MULTIFUNCIONAL 9 FUNÇÕES

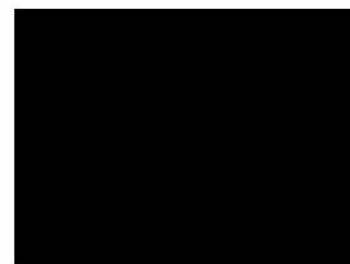

BOMVINK

CÓD. DESCRIÇÃO
8414 CANIVETE SUIÇO MULTIFUNÇÕES



BOMVINK

CÓD. DESCRIÇÃO
8725 PAQUÍMETRO ANALÓGICO PLÁSTICO C/ 2 PEÇAS



BOMVINK

CÓD. DESCRIÇÃO
8486 PAQUÍMETRO UNIVERSAL DIGITAL



BOMVINK

CÓD. DESCRIÇÃO
8485 PAQUÍMETRO UNIVERSAL ANALÓGICO

FERRAMENTAS E UTILIDADES



CÓD. DESCRIÇÃO
2899 DESEMP. PLAST. 17 X 30 CM LISA
2900 DESEMP. PLAST. 17 X 30 CM CORRUGADA



GRAFIATO



CÓD. DESCRIÇÃO
2898 DESEMP. GRAFIATO 17 X 30 CM PREMIUM



SS LARES MG

CÓD. DESCRIÇÃO
6767 DESEMP. PLASTICA 18X30 C/ ESPUMA



CÓD. DESCRIÇÃO
2902 DESEMP. PLASTICA 14X27 C/ BORRACHA PRETA



CÓD. DESCRIÇÃO
5797 DESEMP. PLASTICA 14X27 C/ ESPUMA
2901 DESEMP. PLASTICA 17X30 C/ ESPUMA



ULTRA

CÓD. DESCRIÇÃO
7417 DESEMPENADEIRA PLASTICA 18X30 C/ BORRACHA



ULTRA

CÓD. DESCRIÇÃO
7420 DESEMPENADEIRA PLASTICA 18X30 C/ESPUMA



THOMPSON

CÓD. DESCRIÇÃO
765 DESEMP. AÇO LISA CABO PLAS. 12X24
1806 DESEMP. AÇO LISA CABO PLAS. 12X48



ATLAS

CÓD. DESCRIÇÃO
2283 DESEMPENADEIRA AÇO DENTADA 8/FECH 12X25



CORTAG

CÓD. DESCRIÇÃO
4324 DESEMP. AÇO DENTADA 38 CM R10
4325 DESEMP. AÇO DENTADA 29 CM R10



ATLAS

CÓD. DESCRIÇÃO
2725 DESEMP. AÇO DENTE/FECH 12X35



THOMPSON

CÓD. DESCRIÇÃO
2405 DESEMP. AÇO LISA 12X24 CD MADEIRA



THOMPSON

CÓD. DESCRIÇÃO
1807 DESEMP. PLÁSTICA 18X30 LISA PRETA
1808 DESEMP. PLÁSTICA 18X30 CORRUGADA PRETA



THOMPSON

CÓD. DESCRIÇÃO
1521 DESEMP. AÇO DENTADA 12X24 CB PLÁSTICO
766 DESEMP. AÇO DENTADA 12X48 CB PLÁSTICO



THOMPSON

CÓD. DESCRIÇÃO
2404 DESEMP. AÇO DENTADA 12X24 CB MADEIRA

FERRAMENTAS E UTILIDADES



ULTRA

CÓD. 7415 DESCRIÇÃO DESEMPENADEIRA PLÁSTICA 18X30 LISA AZUL

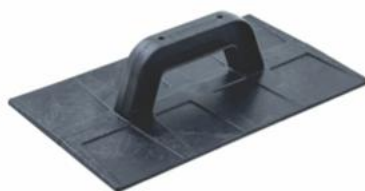

SS LARES MG

CÓD. 6679 DESCRIÇÃO DESEMP. PLÁSTICA 18X30 CM CORRUGADA PRETA
6680 DESEMP. PLÁSTICA 18X30 CM LISA PRETA



ULTRA

CÓD. 7418 DESCRIÇÃO DESEMPENADEIRA PLÁSTICA 18X30 ESTRIADA PRETA



ULTRA

CÓD. 7419 DESCRIÇÃO DESEMPENADEIRA PLÁSTICA 18X30 LISA PRETA



CÓD. 1453 DESCRIÇÃO DESEMP. PLÁSTICA ESTRIADA 17 X 30 CM PRE.
1454 DESEMP. PLÁSTICA LISA 17 X 30 CM PRE.



ULTRA

CÓD. 7416 DESCRIÇÃO DESEMPENADEIRA PLÁSTICA 18X30 ESTRIADA AZUL



ATLAS

CÓD. 3973 DESCRIÇÃO DESEMPENADEIRA P/ TEXT DE PLAST 17X14CM



ULTRA

CÓD. 7020 DESCRIÇÃO ESPÁTULA EVA REJUNTA FÁCIL



ATLAS

CÓD. 7142 DESCRIÇÃO ESPATULA PLÁSTICA 13,1 CM



ULTRA

CÓD. 7694 DESCRIÇÃO ESPÁTULA REJUNTE EVA KIT COM 10



BOMVINK

CÓD. 8331 DESCRIÇÃO ESPÁTULA MULTIFUNCIONAL 3 EM 1



PACETTA

CÓD. 2163 DESCRIÇÃO ESPÁTULA LAMINADA 04 CM
21642165 ESPÁTULA LAMINADA 06 CM
21652166 ESPÁTULA LAMINADA 08 CM
2166 ESPÁTULA LAMINADA 10 CM



THOMPSON

CÓD. 767 DESCRIÇÃO ESPÁTULA CB PLÁSTICO 02 CM
768769 ESPÁTULA CB PLÁSTICO 04 CM
769770 ESPÁTULA CB PLÁSTICO 06 CM
770771 ESPÁTULA CB PLÁSTICO 08 CM
771772 ESPÁTULA CB PLÁSTICO 10 CM
772 ESPÁTULA CB PLÁSTICO 12 CM



ATLAS

CÓD. 2290 DESCRIÇÃO ESPÁTULA DE AÇO 4 CM
22912292 ESPÁTULA DE AÇO 6 CM
22922288 ESPÁTULA DE AÇO 8 CM
22882289 ESPÁTULA DE AÇO 10 CM
2289 ESPÁTULA DE AÇO 12 CM



ATLAS

CÓD. 2720 DESCRIÇÃO ESPÁTULA AÇO CROMADO 3,8 CM
27212722 ESPÁTULA AÇO CROMADO 6,3 CM
27222723 ESPÁTULA AÇO CROMADO 7,6 CM
27236535 ESPÁTULA AÇO CROMADO 10,2 CM
6535 ESPÁTULA AÇO CROMADO 15 CM

FERRAMENTAS E UTILIDADES



TRAMONTINA

CÓD.	DESCRIÇÃO
4655	ESPATULA AÇO C/CABO MAD 06CM
4650	ESPATULA AÇO C/CABO MAD 08CM
4656	ESPATULA AÇO C/CABO MAD 10CM
4657	ESPATULA AÇO C/CABO MAD 12CM



TRAMONTINA

CÓD.	DESCRIÇÃO
4658	ESPATULA AÇO C/CABO PLAST 04CM
4659	ESPATULA AÇO C/CABO PLAST 06CM
4660	ESPATULA AÇO C/CABO PLAST 08CM
4661	ESPATULA AÇO C/CABO PLAST 10CM
4662	ESPATULA AÇO C/CABO PLAST 12CM



Famastil

CÓD.	DESCRIÇÃO
5394	ESPATULA DE AÇO CABO PVC 04 CM
5395	ESPATULA DE AÇO CABO PVC 06 CM
5396	ESPATULA DE AÇO CABO PVC 08 CM



Famastil

CÓD.	DESCRIÇÃO
3848	ESQUADRO POLIPROPILENO 14" FAMASTIL



TRAMONTINA

CÓD.	DESCRIÇÃO
4745	ESQUADRO ACO TEMPERADO 12

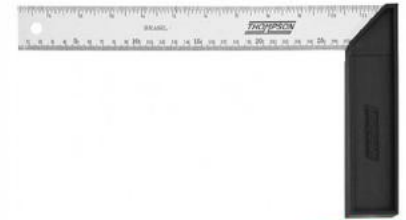

THOMPSON

CÓD.	DESCRIÇÃO
1940	ESQUADRO PVC 12" THOMPSON
1941	ESQUADRO PVC 14" THOMPSON



MEGA
IMPORTADORA

CÓD.	DESCRIÇÃO
1078	ESQUADRO QUADRO ALUMINIO 12" MEGA



ULTRA
FERRAMENTAS

CÓD.	DESCRIÇÃO
7034	ESQUADRO PVC 12"



THOMPSON

CÓD.	DESCRIÇÃO
5119	ESQUADRO CB METALICO 12" THOMPSON
5120	ESQUADRO CB METALICO 14" THOMPSON



TRAMONTINA

CÓD.	DESCRIÇÃO
4760	MARRETA 1 KG C/ CABO
47104709	MARRETA 1,5 KG C/ CABO
47094711	MARRETA 1/2 KG C/ CABO
4711	MARRETA 2 KG C/ CABO



MINASUL

CÓD.	DESCRIÇÃO
1551	MARRETA 1,2KG C/ CABO
15521553	MARRETA 1KG C/ CABO
15531554	MARRETA 1,5KG C/ CABO
15541555	MARRETA 2KG C/ CABO
15555079	MARRETA 3KG C/ CABO
5079	MARRETA 5KG C/ CABO



ULTRA
FERRAMENTAS

CÓD.	DESCRIÇÃO
7021	MARTELO BORRACHA 40 MM PRETO PROFESSIONAL
7016	MARTELO BORRACHA 60 MM PRETO PROFESSIONAL
7035	MARTELO BORRACHA 80 MM PRETO PROFESSIONAL



metasul

CÓD.	DESCRIÇÃO
1446	MARTELO BORRACHA PVC 40 MM
13071308	MARTELO BORRACHA PVC 50 MM BRANCO
13081309	MARTELO BORRACHA PVC 60 MM
1309	MARTELO BORRACHA PVC 80 MM



THOMPSON















CÓD.	DESCRIÇÃO
1815	MARTELO BORRACHA PRETO 40 MM
18161817	MARTELO BORRACHA PRETO 60 MM
1817	MARTELO BORRACHA PRETO 80 MM



THOMPSON

CÓD.	DESCRIÇÃO
1942	MARTELO BORRACHA BRANCO 40 MM
1943	MARTELO BORRACHA BRANCO 60 MM

FERRAMENTAS E UTILIDADES

 <p>São Romão</p>	 <p>BOMVINK</p>	 <p>BOMVINK</p>
<p>CÓD. DESCRIÇÃO 5918 MARTELO 2 CORTES P/PEDREIRO</p>	<p>CÓD. DESCRIÇÃO 8437 MARTELO UNHA 270G CABO SILICONADO 8558 MARTELO UNHA 500G CABO SILICONADO</p>	<p>CÓD. DESCRIÇÃO 8417 KIT FERRAMENTAS 5 PEÇAS</p>
 <p>THOMPSON</p>	 <p>MINASUL</p>	 <p>THOMPSON</p>
<p>CÓD. DESCRIÇÃO 7318 MARTELO POLIDO CABO DE MADEIRA 23MM 5130 MARTELO POLIDO CABO DE MADEIRA 25MM 2116 MARTELO POLIDO CABO DE MADEIRA 27MM 2117 MARTELO POLIDO CABO DE MADEIRA 29MM</p>	<p>CÓD. DESCRIÇÃO 1558 MARTELO PINTADO C/UNHA 25 MM 15591560 MARTELO PINTADO C/UNHA 27 MM 1560 MARTELO PINTADO C/UNHA 29 MM</p>	<p>CÓD. DESCRIÇÃO 3349 MARTELO POLIDO CABO DE FIBRA 25MM 3350 MARTELO POLIDO CABO DE FIBRA 27MM</p>
 <p>GORTAG</p>	 <p>TRAMONTINA</p>	 <p>MEGA IMPORTADORA</p>
<p>CÓD. DESCRIÇÃO 3497 MARTELO CABO DE FIBRA 23 MM 34983290 MARTELO CABO DE FIBRA 25 MM 32903499 MARTELO CABO DE FIBRA 27 MM 3499 MARTELO CABO DE FIBRA 29 MM</p>	<p>CÓD. DESCRIÇÃO 4703 MARTELO CABO MAD. C/ UNHA 18MM 47044705MARTELO CABO MAD. C/ UNHA 20MM 47054706MARTELO CABO MAD. C/ UNHA 23MM 47064707MARTELO CABO MAD. C/ UNHA 25MM 47074708MARTELO CABO MAD. C/ UNHA 27MM 4708 MARTELO CABO MAD. C/ UNHA 29MM</p>	<p>CÓD. DESCRIÇÃO 1080 MARTELO CABO DE FIBRA 25 MM 1079 MARTELO CABO DE FIBRA 27 MM</p>
 <p>THOMPSON</p>	 <p>PACETTA</p>	 <p>Famastil</p>
<p>CÓD. DESCRIÇÃO 7310 FORMAO PREMIUM 1 1/2 CHANFRADO 7311 FORMAO PREMIUM 1 1/4 CHANFRADO 7312 FORMAO PREMIUM 1 CHANFRADO 7313 FORMAO PREMIUM 1/2 CHANFRADO 7314 FORMAO PREMIUM 1/4 CHANFRADO 7315 FORMAO PREMIUM 3/4 CHANFRADO 7316 FORMAO PREMIUM 3/8 CHANFRADO 7317 FORMAO PREMIUM 5/8 CHANFRADO</p>	<p>CÓD. DESCRIÇÃO 2167 FORMÃO CHANFRADO 1/4 21702172 FORMÃO CHANFRADO 1/2 21722174 FORMÃO CHANFRADO 3/4 21742175 FORMÃO CHANFRADO 1 21752176 FORMÃO CHANFRADO 1.1/4 21762169 FORMÃO CHANFRADO 1.1/2 21692168 FORMÃO CHANFRADO 3/8 21682171 FORMÃO CHANFRADO 5/16 21712173 FORMÃO CHANFRADO 5/8 2173 FORMÃO CHANFRADO 7/8</p>	<p>CÓD. DESCRIÇÃO 5405 FORMÃO CABO MADEIRA 1/2 5407 FORMÃO CABO MADEIRA 3/8 5408 FORMÃO CABO MADEIRA 5/8</p>
 <p>São Romão</p>	 <p>São Romão</p>	 <p>São Romão</p>
<p>CÓD. DESCRIÇÃO 1020 TALHADEIRA AÇO CHATO 10" 1021 TALHADEIRA AÇO CHATO 12"</p>	<p>CÓD. DESCRIÇÃO 5746 TALHADEIRA REDONDA 10" 5747 TALHADEIRA REDONDA 12"</p>	<p>CÓD. DESCRIÇÃO 1018 PONTEIRO REDONDO 10" 1019 PONTEIRO REDONDO 12"</p>

FERRAMENTAS E UTILIDADES



THOMPSON

CÓD. DESCRIÇÃO

5582 PRUMO CENTRO 500GR



THOMPSON

CÓD. DESCRIÇÃO

1944 PRUMO PLÁSTICO AMARELO E PRETO 420GR



THOMPSON

CÓD. DESCRIÇÃO

5131 PRUMO AÇO MACIÇO 400 G
1377 PRUMO AÇO MACIÇO 1 KG
774775 PRUMO AÇO MACIÇO 5-500GR
775 PRUMO AÇO MACIÇO 7-750GR



TRAMONTINA

CÓD. DESCRIÇÃO

4674 PRUMO 500G TRAMONTINA



ULTRA

CÓD. DESCRIÇÃO

7011 PRUMO AÇO MACIÇO 500 G



Cortag

CÓD. DESCRIÇÃO

2613 PRUMO AÇO MACIÇO 1 KG
26142615 PRUMO AÇO MACIÇO 500 G
2615 PRUMO AÇO MACIÇO 750 G



PACETTA
SPECIALIDADE EM FERRAMENTAS

CÓD. DESCRIÇÃO

2158 COLHER PEDREIRO CANTO RETO Nº 06
21592160 COLHER PEDREIRO CANTO RETO Nº 07
21602161 COLHER PEDREIRO CANTO RETO Nº 08
21612162 COLHER PEDREIRO CANTO RETO Nº 09
2162 COLHER PEDREIRO CANTO RETO Nº 10



TRAMONTINA

CÓD. DESCRIÇÃO

4653 COLHER PEDREIRO CANTO RETO N 07 TRAMONTINA
46514652 COLHER PEDREIRO CANTO RETO N 08 TRAMONTINA
46544655 COLHER PEDREIRO CANTO RETO N 09 TRAMONTINA
4652 COLHER PEDREIRO CANTO RETO N 10 TRAMONTINA



Cortag

CÓD. DESCRIÇÃO

6967 COLHER PEDREIRO CANTO RETO N 7 CORTAG
6968 COLHER PEDREIRO CANTO RETO N 8 CORTAG
6969 COLHER PEDREIRO CANTO RETO N 9 CORTAG
6966 COLHER PEDREIRO CANTO RETO N 10 CORTAG



THOMPSON

CÓD. DESCRIÇÃO

1791 COLHER PEDREIRO CANTO RETO N 07
7581187 COLHER PEDREIRO CANTO RETO N 08
11874065 COLHER PEDREIRO CANTO RETO N 09
4065 COLHER PEDREIRO CANTO RETO N 10



TRAMONTINA

CÓD. DESCRIÇÃO

6300 LÁPIS CARPINTEIRO 40 UNIDADE



THOMPSON

CÓD. DESCRIÇÃO

759 LÁPIS CARPINTEIRO 72 UNIDADES



IRWIN

CÓD. DESCRIÇÃO

8229 LÁPIS PARA CARPINTEIRO IRWIN 72 UNIDADES



TORALF

CÓD. DESCRIÇÃO

1217 LINHA PEDREIRO 100MTS - LINHA TORALF
1216 LINHA PEDREIRO 50MTS - LINHA TORALF



lm

CÓD. DESCRIÇÃO

8785 LINHA DE PEDREIRO 100 MTS 8 FIOS
8784 LINHA DE PEDREIRO 50 MTS 8 FIOS
8783 LINHA DE PEDREIRO LISA LARANJA COM 100 MTS
8782 LINHA DE PEDREIRO LISA LARANJA COM 50 MTS



BOMVINK

CÓD. DESCRIÇÃO

9017 LÁPIS PARA CARPINTEIRO 12 UNIDADES

FERRAMENTAS E UTILIDADES



CÓD.	DESCRIÇÃO
1466	CORTADOR PROFISSIONAL TEC 75
1467	CORTADOR PROFISSIONAL TEC 90



CÓD.	DESCRIÇÃO
6386	CORTADOR MASTER 115
8833	CORTADOR PROFISSIONAL HD-900 G2 90CM



THOMPSON

CÓD.	DESCRIÇÃO
763764	CORTADOR DE PISO PROFISSIONAL MAC 75
7644070	CORTADOR DE PISO PROFISSIONAL MAC 90
4070	CORTADOR PROFISSIONAL MAC 1000 (1 METRO)



CÓD.	DESCRIÇÃO
8245	CORTADOR PROFISSIONAL TEC 75



CÓD.	DESCRIÇÃO
8220	CORTADOR DE PISO 90 CM



CÓD.	DESCRIÇÃO
1463	RODEL 80 MM
6975	RODEL 100 MM



THOMPSON

CÓD.	DESCRIÇÃO
1188	RODEL 80 MM



CÓD.	DESCRIÇÃO
6971	ESPAÇADOR P/NIVELAMENTO 1,0 MM
69726973	ESPAÇADOR P/NIVELAMENTO 1,5 MM
69736974	ESPAÇADOR P/NIVELAMENTO 2 MM
6974	ESPAÇADOR P/NIVELAMENTO 3 MM



CÓD.	DESCRIÇÃO
8834	ESPAÇADOR P/NIVELAMENTO 1,0 MM SLIM
88368838	ESPAÇADOR P/NIVELAMENTO 1,5 MM SLIM
88388835	ESPAÇADOR P/NIVELAMENTO 2 MM SLIM
8835	ESPAÇADOR P/NIVELAMENTO 3 MM SLIM



CÓD.	DESCRIÇÃO
2105	ESPAÇADOR P/NIVELAMENTO 1,0 MM
14681469	ESPAÇADOR P/NIVELAMENTO 1,5 MM
14693496	ESPAÇADOR P/NIVELAMENTO 2 MM
3496	ESPAÇADOR P/NIVELAMENTO 3 MM



CÓD.	DESCRIÇÃO
6962	ESPAÇADOR P/NIVELAMENTO 1,0 MM
69636964	ESPAÇADOR P/NIVELAMENTO 1,5 MM
6964	ESPAÇADOR P/NIVELAMENTO 2 MM



CÓD.	DESCRIÇÃO
3266	ESPAÇADOR P/ NIVELAMENTO 1,0 MM
3267	ESPAÇADOR P/ NIVELAMENTO 1,5 MM



CÓD.	DESCRIÇÃO
1458	ESPAÇADOR JUNTA PISO 1 MM
14571459	ESPAÇADOR JUNTA PISO 1,5 MM
14591460	ESPAÇADOR JUNTA PISO 2 MM
14601461	ESPAÇADOR JUNTA PISO 3 MM
14611462	ESPAÇADOR JUNTA PISO 4 MM
1462	ESPAÇADOR JUNTA PISO 5 MM

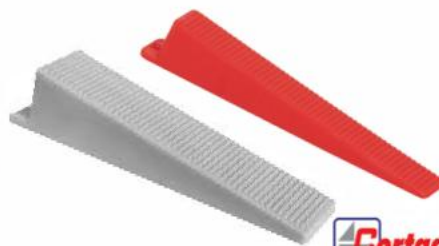

CÓD.	DESCRIÇÃO
1470	CUNHA P/NIVELAMENTO
8837	CUNHA P/NIVELAMENTO SLIM



CÓD.	DESCRIÇÃO
6965	CUNHA P/NIVELAMENTO

FERRAMENTAS E UTILIDADES



IRWIN

CÓD.	DESCRIÇÃO
8219	BROCA FIBROCIMENTO E MOURÃO 1/2 X 400
82188211	BROCA FIBROCIMENTO E MOURÃO 9/32 X 250
82118210	BROCA FIBROCIMENTO E MOURÃO 3/8 X 320
82108209	BROCA FIBROCIMENTO E MOURÃO 5/16 X 280
8209	BROCA FIBROCIMENTO E MOURÃO 1/4 X 250



IRWIN

CÓD.	DESCRIÇÃO
8212	BROCA CONCRETO 07MM
8208	BROCA CONCRETO 12MM
8207	BROCA CONCRETO 10MM
8204	BROCA CONCRETO 08MM
8203	BROCA CONCRETO 06MM
8002	BROCA CONCRETO 05MM
8201	BROCA CONCRETO 04MM



IRWIN

CÓD.	DESCRIÇÃO
8215	BROCA DE CONCRETO EXTRA LONGA 12.0MMX330
8214	BROCA DE CONCRETO EXTRA LONGA 10.0MMX330
8213	BROCA DE CONCRETO EXTRA LONGA 8MMX330



TRAMONTINA

CÓD.	DESCRIÇÃO
5326	BROCA PARA ACO 4,5MM
5327	BROCA PARA ACO 6MM
5328	BROCA PARA ACO 8MM
5329	BROCA PARA ACO 10MM
5330	BROCA PARA ACO 1/8
5331	BROCA PARA ACO 3/8
5332	BROCA PARA ACO 1/2
5333	BROCA PARA ACO 2,5MM
6323	BROCA PARA ACO 5,5MM
6324	BROCA PARA ACO 6,5MM
6325	BROCA PARA ACO 7MM
6326	BROCA PARA ACO 12MM
6327	BROCA PARA ACO 11/64
6328	BROCA PARA ACO 13/64
6329	BROCA PARA ACO 7/32
6330	BROCA PARA ACO 9/32
6331	BROCA PARA ACO 5/16
6334	BROCA PARA ACO 1,5MM
6335	BROCA PARA ACO 2MM
6336	BROCA PARA ACO 3MM
6337	BROCA PARA ACO 3,5MM
6338	BROCA PARA ACO 4MM
6339	BROCA PARA ACO 5MM
6340	BROCA PARA ACO 1/16
6341	BROCA PARA ACO 5/64
6342	BROCA PARA ACO 3/32
6343	BROCA PARA ACO 7/64
6344	BROCA PARA ACO 9/64
6345	BROCA PARA ACO 5/32
6346	BROCA PARA ACO 3/16
6347	BROCA PARA ACO 1/4



IRWIN

CÓD.	DESCRIÇÃO
8206	BROCA AÇO RÁPIDO 11/64
8205	BROCA AÇO RÁPIDO 5/64
8200	BROCA AÇO RÁPIDO 1/2
8199	BROCA AÇO RÁPIDO 7/16
8198	BROCA AÇO RÁPIDO 3/8
8197	BROCA AÇO RÁPIDO 5/16
8196	BROCA AÇO RÁPIDO 1/4
8194	BROCA AÇO RÁPIDO 12/50
8193	BROCA AÇO RÁPIDO 5/32
8192	BROCA AÇO RÁPIDO 9/64
8191	BROCA AÇO RÁPIDO 1/2
8190	BROCA AÇO RÁPIDO 12MM
8185	BROCA AÇO RÁPIDO 11
8184	BROCA AÇO RÁPIDO 10/50
8183	BROCA AÇO RÁPIDO 10
8182	BROCA AÇO RÁPIDO 9/5
8181	BROCA AÇO RÁPIDO 9
8180	BROCA AÇO RÁPIDO 8/5
8179	BROCA AÇO RÁPIDO 7/5
8178	BROCA AÇO RÁPIDO 8
8177	BROCA AÇO RÁPIDO 7
8176	BROCA AÇO RÁPIDO 6/5
8175	BROCA AÇO RÁPIDO 6
8174	BROCA AÇO RÁPIDO 5/50
8173	BROCA AÇO RÁPIDO 5
8172	BROCA AÇO RÁPIDO 4/50
8171	BROCA AÇO RÁPIDO 4
8170	BROCA AÇO RÁPIDO 3/5
8169	BROCA AÇO RÁPIDO 3
8168	BROCA AÇO RÁPIDO 2/5
8167	BROCA AÇO RÁPIDO 2



IRWIN

CÓD.	DESCRIÇÃO
8216	BROCA SDS PLUS 06X160MM
8217	BROCA SDS PLUS 08X210MM



TRAMONTINA

CÓD.	DESCRIÇÃO
5651	BROCA CHATA P/ MADEIRA 3/8 X 150MM
5652	BROCA CHATA P/ MADEIRA 1/4 X 150MM
5653	BROCA CHATA P/ MADEIRA 5/16 X 150MM
5654	BROCA CHATA P/ MADEIRA 5/8 X 150MM
5655	BROCA CHATA P/ MADEIRA 3/4 X 150MM
6350	BROCA CHATA P/ MADEIRA 1/2 X 150MM



TRAMONTINA

CÓD.	DESCRIÇÃO
5334	BROCA PARA CONCRETO 6MM
5335	BROCA PARA CONCRETO 8MM
5336	BROCA PARA CONCRETO 10MM
5337	BROCA PARA CONCRETO 12MM



THOMPSON

CÓD.	DESCRIÇÃO
1896	BROCA CONCRETO K - LONGA K 6 X 350 MM
794	BROCA CONCRETO L - LONGA L 8 X 350 MM
795	BROCA CONCRETO M - LONGA M 10 X 350 MM
1897	BROCA CONCRETO N - LONGA N 12 X 350 MM



THOMPSON

CÓD.	DESCRIÇÃO
1873	BROCA A.R.A - 3/64 1,00 MM
783	BROCA A.R.B - 1/16 1,50 MM
784	BROCA A.R.C - 5/64 2,00 MM
785	BROCA A.R.D - 3/32 2,50 MM
1874	BROCA A.R.E - 7/64 2,70 MM
786	BROCA A.R.F - 1/8 3,00 MM
1875	BROCA A.R.G - 9/64 3,50 MM
1876	BROCA A.R.H - 5/32 4,00 MM
1877	BROCA A.R.I - 11/64 4,50 MM
787	BROCA A.R.J - 3/16 4,70 MM
1878	BROCA A.R.K - 13/64 5,00 MM
1879	BROCA A.R.L - 7/32 5,50 MM
788	BROCA A.R.M - 15/64 6,00 MM
789	BROCA A.R.N - 1/4 6,50 MM
1880	BROCA A.R.O - 9/32 7,00 MM
1881	BROCA A.R.P - 19/64 7,50 MM
1773	BROCA A.R.Q - 5/16 8,00 MM
1882	BROCA A.R.R - 21/64 8,50 MM
1883	BROCA A.R.S - 23/64 9,00 MM
1774	BROCA A.R.T - 3/8 9,50 MM
1884	BROCA A.R.U - 25/64 10,00 MM
1885	BROCA A.R.V - 13/32 10,50 MM
1886	BROCA A.R.W - 7/16 11,00 MM
1887	BROCA A.R.X - 29/64 11,50 MM
1888	BROCA A.R.Y - 15/32 12,00 MM
1889	BROCA A.R.Z - 1/2 12,50 MM



THOMPSON

CÓD.	DESCRIÇÃO
1775	BROCA CHATA P/ MADEIRA 1/4
17761777	BROCA CHATA P/ MADEIRA 5/16
17771778	BROCA CHATA P/ MADEIRA 3/8
17781779	BROCA CHATA P/ MADEIRA 7/16
17791780	BROCA CHATA P/ MADEIRA 1/2
17801781	BROCA CHATA P/ MADEIRA 9/16
17811782	BROCA CHATA P/ MADEIRA 11/16
17821783	BROCA CHATA P/ MADEIRA 3/4
1783	BROCA CHATA P/ MADEIRA 7/8

















THOMPSON

CÓD.	DESCRIÇÃO
1890	BROCA CONCRETO - 3 X 60 MM
1891	BROCA CONCRETO - 4 X 75 MM
1892	BROCA CONCRETO - 5 X 85 MM
790	BROCA CONCRETO - 6 X 100 MM
1893	BROCA CONCRETO - 6,5 X 100 MM
1894	BROCA CONCRETO - 7 X 100 MM
791	BROCA CONCRETO - 8 X 120 MM
1895	BROCA CONCRETO - 9,5 X 120 MM
792	BROCA CONCRETO - 10 X 120 MM
793	BROCA CONCRETO - 12 X 150 MM

FERRAMENTAS E UTILIDADES

 <p>CORTAG PORCELANATO</p> <p>DISCO DE CORTE DIAMANTADO DIAMOND CUTTING BLADE</p> <p>15.000 RPM</p> <p>EN 12336</p>	 <p>CORTAG TURBO ECO</p> <p>DISCO DE CORTE DIAMANTADO DIAMOND CUTTING BLADE</p> <p>15.000 RPM</p> <p>EN 12336</p>	 <p>ULTRA</p> <p>15.000 RPM</p> <p>Liso 110x08mm Azulejo e Cerâmica</p>
<p>CÓD. DESCRIÇÃO</p> <p>1465 DISCO DIAMANTADO PORCELANATO</p>	<p>CÓD. DESCRIÇÃO</p> <p>1464 DISCO DIAMANTADO TURBO ECO</p>	<p>CÓD. DESCRIÇÃO</p> <p>6368 DISCO DIAMANTADO LISO</p>
 <p>ULTRA</p> <p>15.000 RPM</p> <p>Turbo 110x08mm Mármore e Granito</p>	 <p>ULTRA</p> <p>15.000 RPM</p> <p>PORCELANATO Turbo Extra Fino 110x08mm</p>	 <p>IRWIN</p>
<p>CÓD. DESCRIÇÃO</p> <p>6366 DISCO DIAMANTADO TURBO</p>	<p>CÓD. DESCRIÇÃO</p> <p>6454 DISCO DIAMANTADO PORCELANATO</p>	<p>CÓD. DESCRIÇÃO</p> <p>8223 DISCO SEGMENTADO DIAMANTADO 8222 DISCO TURBO DIAMANTADO 8221 DISCO LISO DIAMANTADO</p>
 <p>THOMPSON</p>	 <p>THOMPSON</p> <p>DISCO DIAMANTADO Turbo Turbo Porcelanato</p> <p>PORCELANATO</p>	 <p>BONO PORCELANATO</p> <p>15.000 RPM</p> <p>LISO 110x08mm</p> <p>ECCO Azulejo e Cerâmica</p>
<p>CÓD. DESCRIÇÃO</p> <p>2379 DISCO DIAMANTADO TURBO 23782377 DISCO DIAMANTADO SEGMENTADO 2377 DISCO DIAMANTADO LISO</p>	<p>CÓD. DESCRIÇÃO</p> <p>6523 DISCO DIAMANTADO PORCELANATO</p>	<p>CÓD. DESCRIÇÃO</p> <p>4934 DISCO DIAMANTADO LISO</p>
 <p>THOMPSON EXCELENCIA EM QUALIDADE</p> <p>Disco Daportado Turbo Solo Mármore</p> <p>Máximo Um Grande Profissional de Qualidade</p>	 <p>OMEGA</p> <p>DISCO TURBO 110 x 08</p> <p>OMEGA</p> <p>DISCO TURBO 110 x 08</p> <p>OMEGA IMPORTADORA</p>	 <p>OMEGA</p> <p>DISCO SEGMENTADO 110 x 08</p> <p>OMEGA</p> <p>DISCO DIAMANTADO 110 x 08</p> <p>OMEGA IMPORTADORA</p>
<p>CÓD. DESCRIÇÃO</p> <p>3347 DISCO DIAMANTADO TURBO 180MM 7"</p>	<p>CÓD. DESCRIÇÃO</p> <p>1087 DISCO DIAMANTADO TURBO</p>	<p>CÓD. DESCRIÇÃO</p> <p>1088 DISCO DIAMANTADO SEGMENTADO</p>
 <p>OMEGA</p> <p>DISCO LISO 110 x 08</p> <p>OMEGA</p> <p>DISCO LISO 110 x 08</p> <p>OMEGA IMPORTADORA</p>	 <p>Aquartzolit</p> <p>ULTRAFINO TURBO PORCELANATO</p> <p>PRO</p> <p>110 x 20 mm 13.500 RPM</p> <p>Aquartzolit</p>	 <p>ULTRA</p> <p>15.000 RPM</p> <p>Segmentado 110x08mm Concreto e Alvenaria</p> <p>ULTRA</p>
<p>CÓD. DESCRIÇÃO</p> <p>1086 DISCO DIAMANTADO LISO</p>	<p>CÓD. DESCRIÇÃO</p> <p>7989 DISCO DIAMANTADO PORCELANATO</p>	<p>CÓD. DESCRIÇÃO</p> <p>6367 DISCO DIAMANTADO SEGMENTADO</p>

FERRAMENTAS E UTILIDADES

 <p>ULTRA TUNGSTÊNIO MADEIRA 110x20mm</p>	 <p>THOMPSON EXCELÊNCIA EM QUALIDADE Disco Diamantado Segmentado Secco - 105mm x 20mm Mármore Concreto / Alvenaria Use Sempre Equipamentos de Segurança</p>	 <p>MEGA DISCO SERRA VIDEA 110 X 24 DENTES</p>
<p>CÓD. DESCRIÇÃO 7602 DISCO CORTE TUNGSTÊNIO PARA MADEIRA</p>	<p>CÓD. DESCRIÇÃO 3345 DISCO DIAMANTADO SEGMENTADO 180MM 7" 3346 DISCO DIAMANTADO SEGMENTADO 230MM 9"</p>	<p>CÓD. DESCRIÇÃO 1203 DISCO SERRA VIDEA 110 X 24 DENTES</p>
 <p>CORTAG 24 DENTES LÂMINA DE SERRA CIRCULAR 118mm PARA MADEIRA Para: 22mm Max. 12.100 RPM</p>	 <p>THOMPSON</p>	 <p>ULTRA 7.500 Corte de Madeira 185mm x 24Dentes</p>
<p>CÓD. DESCRIÇÃO 2609 DISCO SERRA CIRCULAR 4 3/8 24 DENTES 2610 DISCO SERRA CIRCULAR 7 1/4 24 DENTES</p>	<p>CÓD. DESCRIÇÃO 3356 DISCO SERRA CIRCULAR 7 1/4 36 DENTES 33573358 DISCO SERRA CIRCULAR 9 1/4 24 DENTES 33582399 DISCO SERRA CIRCULAR 9 1/4 36 DENTES 23952399 DISCO SERRA CIRCULAR 4 3/8 24 DENTES 2396 DISCO SERRA CIRCULAR 7 1/4 24 DENTES</p>	<p>CÓD. DESCRIÇÃO 6370 DISCO SERRA CIRCULAR 7 1/4 24 DENTES 7245 DISCO SERRA CIRCULAR 7 1/4 36 DENTES 6369 DISCO SERRA CIRCULAR 4 3/8 24 DENTES</p>
 <p>BONO</p>	 <p>Bestfer</p>	 <p>ULTRA 110x1,2x22,3mm MAX RPM 13.300 BOMBS AÇO/INOX</p>
<p>CÓD. DESCRIÇÃO 4937 DISCO SERRA CIRCULAR 4 3/8 24 DENTES 4938 DISCO SERRA CIRCULAR 7 1/4 24 DENTES</p>	<p>CÓD. DESCRIÇÃO 7713 DISCO CORTE INOX 4 1/2</p>	<p>CÓD. DESCRIÇÃO 4936 DISCO CORTE INOX 4 1/2</p>
 <p>MEGA DISCO DE CORTE INOX 190 x 1,6 x 22,2 mm</p>	 <p>THOMPSON DISCO DE CORTE METAL / AÇO INOX</p>	 <p>Cibra Sider</p>
<p>CÓD. DESCRIÇÃO 3480 DISCO CORTE INOX 7 X 1,6 1084 DISCO CORTE INOX 4 1/2</p>	<p>CÓD. DESCRIÇÃO 1920 DISCO CORTE INOX 4.1/2 1921 DISCO CORTE INOX 7X1,6</p>	<p>CÓD. DESCRIÇÃO 8452 DISCO DESBASTE 7" CIBRA 8451 DISCO DESBASTE 4.1/2" CIBRA 8450 DISCO CORTE INOX 4 1/2 CIBRA</p>
 <p>Bestfer</p>	 <p>Bestfer</p>	 <p>Cortag</p>
<p>CÓD. DESCRIÇÃO 7695 ESCOVA CIRCULAR ONDULADA 6 POL</p>	<p>CÓD. DESCRIÇÃO 7800 SUPORTE PARA DISCO DE LIXA COM VELCRO 4.5 POL</p>	<p>CÓD. DESCRIÇÃO 6970 DISCO DESBASTE P/ CONCRETO 4.1/2" TURBO</p>

FERRAMENTAS E UTILIDADES



CÓD.	DESCRIÇÃO
1946	DISCO BORRACHA 4/12 FLEXÍVEL (BOSCH)
1945	DISCO BORRACHA 4/12 SEMI-RÍGIDO (MAKITA)
1947	DISCO DE BORRACHA 7" FLEXÍVEL



CÓD.	DESCRIÇÃO
4057	DISCO DESBASTE 7"



CÓD.	DESCRIÇÃO
7556	DISCO REBOLO RETO 6"- GRÃO 24"
7557	DISCO REBOLO RETO 6"- GRÃO 46"
7558	DISCO REBOLO RETO 6"- GRÃO 60"



CÓD.	DESCRIÇÃO
8796	DISCO CORTE INOX 4.1/2"



CÓD.	DESCRIÇÃO
8800	DISCO DIAMANTADO PORCELANATO



CÓD.	DESCRIÇÃO
8799	DISCO DIAMANTADO TURBO



CÓD.	DESCRIÇÃO
4437	DISCO FLAP 3M 4 1/2" - GRAO 40
4439	DISCO FLAP 3M 4 1/2" - GRAO 60
4441	DISCO FLAP 3M 4 1/2" - GRAO 80
4443	DISCO FLAP 3M 4 1/2" - GRAO 120
4438	DISCO FLAP 3M 7" - GRAO 40
4440	DISCO FLAP 3M 7" - GRAO 60
4442	DISCO FLAP 3M 7" - GRAO 80
4444	DISCO FLAP 3M 7" - GRAO 120



CÓD.	DESCRIÇÃO
1792	DISCO FLAP 4.1/2" GRÃO 40
17931794	DISCO FLAP 4.1/2" GRÃO 60
17941795	DISCO FLAP 4.1/2" GRÃO 80
17951796	DISCO FLAP 4.1/2" GRÃO 120
17961797	DISCO FLAP 7" GRÃO 40
17971798	DISCO FLAP 7" GRÃO 60
17981799	DISCO FLAP 7" GRÃO 80
1799	DISCO FLAP 7" GRÃO 120



CÓD.	DESCRIÇÃO
8797	DISCO DIAMANTADO LISO



CÓD.	DESCRIÇÃO
7801	DISCO LIXA VELCRO 24 115M
7802	DISCO LIXA VELCRO 36 115M
7803	DISCO LIXA VELCRO 40 115M
7804	DISCO LIXA VELCRO 60 115M
7805	DISCO LIXA VELCRO 80 115M
7806	DISCO LIXA VELCRO 100 115M
7807	DISCO LIXA VELCRO 120 115M
7808	DISCO LIXA VELCRO 150 115M
7809	DISCO LIXA VELCRO 180 115M



CÓD.	DESCRIÇÃO
4423	DISCO LIXA 3M 4.1/2 - 24
4425	DISCO LIXA 3M 4.1/2 - 36
7133	DISCO LIXA 3M 4.1/2 - 50
4428	DISCO LIXA 3M 4.1/2 - 60
4430	DISCO LIXA 3M 4.1/2 - 80
4432	DISCO LIXA 3M 4.1/2 - 100
4434	DISCO LIXA 3M 4.1/2 - 120
4455	DISCO LIXA 3M 7" - 16
4424	DISCO LIXA 3M 7" - 24
4426	DISCO LIXA 3M 7" - 36
4427	DISCO LIXA 3M 7" - 50
4429	DISCO LIXA 3M 7" - 60
4431	DISCO LIXA 3M 7" - 80
4433	DISCO LIXA 3M 7" - 100



CÓD.	DESCRIÇÃO
2380	DISCO LIXA 4.1/2 - 16
23812382	DISCO LIXA 4.1/2 - 24
23822383	DISCO LIXA 4.1/2 - 36
23832384	DISCO LIXA 4.1/2 - 50
23842385	DISCO LIXA 4.1/2 - 60
23852386	DISCO LIXA 4.1/2 - 80
23862387	DISCO LIXA 4.1/2 - 100
23872388	DISCO LIXA 4.1/2 - 120
23882389	DISCO LIXA 4.1/2 - 180
23892390	DISCO LIXA 7" - 36
23902391	DISCO LIXA 7" - 50
23912392	DISCO LIXA 7" - 60
23922393	DISCO LIXA 7" - 80
23932394	DISCO LIXA 7" - 100
2394	DISCO LIXA 7" - 120

FERRAMENTAS E UTILIDADES

 <p>Navalha Disco Diamantado Segmentado</p> <p>4.315</p> <p>Titanium PLATINA</p>	 <p>THOMPSON</p> <p>Disco de Corte Turbo com Ponta de Corte Ultra-afiada</p> <p>1 ANO</p> <p>PORCELANATO</p> <p>THOMPSON</p>	 <p>Cortag</p>
<p>CÓD. 8798</p> <p>DESCRIÇÃO DISCO DIAMANTADO SEGMENTADO</p>	<p>CÓD. 8808</p> <p>DESCRIÇÃO DISCO DIAMANTADO TURBO (FURO 22MM)</p>	<p>CÓD. 2618</p> <p>DESCRIÇÃO TALHA. ENCAIXE TIPO SDS PLUS 20 X 250 MM</p> <p>CÓD. 2619</p> <p>DESCRIÇÃO TALHA. ENCAIXE TIPO SDS PLUS 40 X 250 MM</p>
 <p>Bestfer</p>	 <p>BOMVINK</p>	 <p>BOMVINK</p>
<p>CÓD. 7811</p> <p>DESCRIÇÃO TALHADEIRA SDS PLUS 14MMX250MMX20MM</p>	<p>CÓD. 8792</p> <p>DESCRIÇÃO TALHADEIRA SDS PLUS 20 X 250MM</p>	<p>CÓD. 8790</p> <p>DESCRIÇÃO TALHADEIRA SDS PLUS 40 X 250MM</p>
 <p>Bestfer</p>	 <p>Cortag</p>	 <p>BOMVINK</p>
<p>CÓD. 7810</p> <p>DESCRIÇÃO PONTEIRO SDS PLUS 14MMX250MM</p>	<p>CÓD. 2612</p> <p>DESCRIÇÃO PONTEIRO C/ ENCAIXE TIPO SDS PLUS</p>	<p>CÓD. 8791</p> <p>DESCRIÇÃO PONTEIRO SDS PLUS 14MM X 250MM</p>

ULTRA

/// FERRAMENTAS



FERRAMENTAS E UTILIDADES



CÓD. 1502 **DESCRIÇÃO** GRAMPEADOR PROFISSIONAL BOMVINK



CÓD. 7812 **DESCRIÇÃO** GRAMPEADOR PROFISSIONAL 4-8MM



CÓD. 7552 **DESCRIÇÃO** FOGAREIRO PORTÁTIL ACENDIMENTO AUTOMÁTICO



CÓD. 7964 **DESCRIÇÃO** MAÇARICO LANÇA CHAMA A GÁS 69CM



CÓD. 8468 **DESCRIÇÃO** AQUECEDOR DE ÁGUA 220V 2000W RABO QUENTE
CÓD. 8467 **DESCRIÇÃO** AQUECEDOR DE ÁGUA 127V 2000W RABO QUENTE



CÓD. 8247 **DESCRIÇÃO** MAÇARICO À GÁS PORTÁTIL IGNIÇÃO AUTOMÁTICA



CÓD. 7816 **DESCRIÇÃO** MAÇARICO A GAS PORTATIL IGNIÇÃO AUTOMÁTICA



CÓD. 8552 **DESCRIÇÃO** MAÇARICO À GÁS PORTÁTIL



CÓD. 2096 **DESCRIÇÃO** JOGO BROCA MADEIRA 5 PEÇAS
CÓD. 2095 **DESCRIÇÃO** JOGO BROCA ACO RAPIDO 5 PECAS
CÓD. 2097 **DESCRIÇÃO** JOGO BROCA VIDEA 5 PECAS



CÓD. 8320 **DESCRIÇÃO** JOGO DE BROCAS 9 PEÇAS

FERRAMENTAS E UTILIDADES



ALIANÇA

CÓD.	DESCRIÇÃO
2823	REGULADOR GAS 504/01 1KG/H
28242825	REGULADOR GAS 505/01 1KG/H
2825	REGULADOR GAS 506/01 1KG/H



THOMPSON

CÓD.	DESCRIÇÃO
7223	VENTOSA P/ VIDROS E PORCELANATOS DUPLA



THOMPSON

CÓD.	DESCRIÇÃO
7222	VENTOSA P/ VIDROS E PORCELANATOS SIMPLES



BOMVINK

CÓD.	DESCRIÇÃO
8823	VENTOSA SIMPLES



BOMVINK

CÓD.	DESCRIÇÃO
8824	VENTOSA DUPLA



ULTRA

CÓD.	DESCRIÇÃO
7847	PROTETOR AURICULAR COM CORDÃO 1110 3M



VALEPLAST

CÓD.	DESCRIÇÃO
2989	PROTETOR AURICULAR (PAR)



3M

CÓD.	DESCRIÇÃO
4673	ESPONJA TININDO M USO 71X100 VERDE/AMARELA



PAGUE 2 LEVE 3

TEK BOND SAINT-GOBAIN

CÓD.	DESCRIÇÃO
5311	ESPONJA MAGICA TEK BOND LEVE 3 PAGUE 2



ULTRA

CÓD.	DESCRIÇÃO
4598	CAPA DE CHUVA G FORRADA MANGA CAPUZ AMAR.
4599	CAPA DE CHUVA GG FORRADA MANGA CAPUZ AMAR.



IMBAT

CÓD.	DESCRIÇÃO
7521	COLETE REFLETIVO LARANJA 1 BOLSO-XG



ULTRA FERRAMENTAS

CÓD.	DESCRIÇÃO
1099	BLOCO DE ESPUMA (FILTRO)
7491	BLOCO ESPUMA GIGANTE (FILTRO)



CORTAG

CÓD.	DESCRIÇÃO
3495	BLOCO DE ESPUMA (FILTRO)



TIGRE

CÓD.	DESCRIÇÃO
7334	BLOCO ESPUMA TIGRE (FILTRO)



VEDAH!

CÓD.	DESCRIÇÃO
8989	BLOCO ESPUMA VEDAH (FILTRO)

FERRAMENTAS E UTILIDADES



THOMPSON

CÓD. DESCRIÇÃO
3094 BALANÇA BANHEIRO ANALÓGICO



THOMPSON

CÓD. DESCRIÇÃO
3097 BALANÇA COZINHA DIGITAL



THOMPSON

CÓD. DESCRIÇÃO
3095 BALANÇA BANHEIRO DIGITAL



THOMPSON

CÓD. DESCRIÇÃO
3096 BALANÇA COZINHA ANALÓGICA



THOMPSON

CÓD. DESCRIÇÃO
4063 BOMBA MANUAL VERTICAL PLÁSTICA



BOMVINK

CÓD. DESCRIÇÃO
8336 BOMBA DE AR MANUAL



THOMPSON

CÓD. DESCRIÇÃO
3323 BOMBA DE AR PEDAL



THOMPSON

CÓD. DESCRIÇÃO
3322 BOMBA DE AR MANUAL VERTICAL METALICA



BOMVINK

CÓD. DESCRIÇÃO
8335 BOMBA DE AR PEDAL ALUMINIO



BOMVINK

CÓD. DESCRIÇÃO
8337 COMPREENSOR DE AR PORTATIL



THOMPSON

CÓD. DESCRIÇÃO
2402 CAIXA DE CORREIO PVC AMARELA



ULTRA

CÓD. DESCRIÇÃO
4896 MASCARA TNT DUPLA PROTECAO



3M

CÓD. DESCRIÇÃO
4308 MÁSCARA P/ PÓ DOBRÁVEL PFF1
4896 MASCARA TNT DUPLA PROTECAO
4309 MÁSCARA P/ PÓ DOBRÁVEL C/ VÁLVULA PFF1



VALEPLAST

CÓD. DESCRIÇÃO
2990 ÓCULOS AMPLA VISÃO JAGUAR INCOLOR



VALEPLAST

CÓD. DESCRIÇÃO
2991 ÓCULOS AMPLA VISÃO SPIDER

FERRAMENTAS E UTILIDADES



3M

CÓD.	DESCRIÇÃO
4436	ÓCULOS 3M VISION 3000 INCOLOR



VALEPLAST

CÓD.	DESCRIÇÃO
2987	ÓCULOS PROTECTOR INCOLOR
2988	ÓCULOS PROTECTOR FUME



VALEPLAST

CÓD.	DESCRIÇÃO
2985	ÓCULOS PROTEÇÃO EVOLUTION INCOLOR
2986	ÓCULOS PROTEÇÃO EVOLUTION FUME



THOMPSON

CÓD.	DESCRIÇÃO
4072	LUVA HELANCA PIGMENTADA (PAR)



IMBAT

CÓD.	DESCRIÇÃO
7537	LUVA RASPA PETROLEIRA 07 CM 9G
7540	LUVA RASPA PETROLEIRA 15 CM 9G
7541	LUVA RASPA PETROLEIRA 20 CM 9G



IMBAT

CÓD.	DESCRIÇÃO
7533	LUVA TRICOTADA LARANJA VULCANIZADA 8 M
7534	LUVA TRICOTADA LARANJA VULCANIZADA 9 G



IMBAT

CÓD.	DESCRIÇÃO
7962	LUVA DE POLIESTER COM PU PRETO-8 M TATIL
7963	LUVA DE POLIESTER COM PU PRETO-9 G TATIL
8727	LUVA DE POLIESTER COM PU PRETO-10 GG TATIL



IMBAT

CÓD.	DESCRIÇÃO
7538	LUVA VAQUETA MISTA PETROLEIRA 9 G



IMBAT

CÓD.	DESCRIÇÃO
7539	LUVA VAQUETA PETROLEIRA 9 G



ULTRA

CÓD.	DESCRIÇÃO
2862	LUVA RASPA LONGA 7 CM REFORÇADA
2863	LUVA RASPA LONGA 15 CM REFORÇADA



THOMPSON

CÓD.	DESCRIÇÃO
3375	LUVA HELANCA (PAR)



THOMPSON

CÓD.	DESCRIÇÃO
1810	LUVA PIGMENTADA (PAR)



MUCAMBO

CÓD.	DESCRIÇÃO
3081	LUVA PRETA REFORÇADA 157 TAM.G
30803082	LUVA PRETA REFORÇADA 157 TAM.M
3082	LUVA PRETA REFORÇADA 157 TAM.XG



IMBAT

CÓD.	DESCRIÇÃO
7535	LUVA TRICOTADA COM BANHO LATEX VERDE 9 G
7536	LUVA TRICOTADA COM BANHO LATEX VERDE 10 GG



IMBAT

CÓD.	DESCRIÇÃO
7526	LUVA AMARELA DE LATEX FORRADA 7 P
7527	LUVA AMARELA DE LATEX FORRADA 8 M
7528	LUVA AMARELA DE LATEX FORRADA 9 G
7529	LUVA AMARELA DE LATEX FORRADA 10 XG

FERRAMENTAS E UTILIDADES



MUCAMBO

CÓD.	DESCRIÇÃO
3078	LUVA VERDE FORRADA 250 TAM.G
30773076	LUVA VERDE FORRADA 250 TAM.M
30763079	LUVA VERDE FORRADA 250 TAM.P
3079	LUVA VERDE FORRADA 250 TAM.XG



IMBAT

CÓD.	DESCRIÇÃO
7530	LUVA TRICOTADA BORRACHA AZUL VULCA 8 M
7531	LUVA TRICOTADA BORRACHA AZUL VULCA 9 G
7532	LUVA TRICOTADA BORRACHA AZUL VULCA 10 XG



IMBAT

CÓD.	DESCRIÇÃO
7522	LUVA PRETA DE LATEX FORRADA 8 M
7523	LUVA PRETA DE LATEX FORRADA 9 G
7524	LUVA PRETA DE LATEX FORRADA 10 GG
7525	LUVA PRETA DE LATEX FORRADA 11 XXG



Induplásticos

CÓD.	DESCRIÇÃO
7595	BALDE PLÁSTICO 12L ALÇA METÁLICA PRETO



THOMPSON

CÓD.	DESCRIÇÃO
1809	BALDE P/ CONCRETO 12 LITROS



Induplásticos

CÓD.	DESCRIÇÃO
8032	LATA DE MASSA 16L PRETA PLÁSTICA



THOMPSON

CÓD.	DESCRIÇÃO
1939	CAIXA MASSA 20L



metasul

CÓD.	DESCRIÇÃO
1306	CAIXA MASSA POLIETILENO 20L



Nova

CÓD.	DESCRIÇÃO
6213	CAIXA MASSA 20L



FORTLEV

CÓD.	DESCRIÇÃO
5882	CAIXA MASSA 20L AZUL AFORT



ALUREM

CÓD.	DESCRIÇÃO
2643	RÉGUA PEDREIRO 2 M BITUBULAR
2644	RÉGUA PEDREIRO 3 M BITUBULAR



BOMVINK

CÓD.	DESCRIÇÃO
8543	DESENTUPIDOR TUBULAÇÃO FLEX 1.60 M C/ GARRAS



Bestfer

CÓD.	DESCRIÇÃO
7548	DESENTUPIDOR DE TUBULAÇÃO 5M X 5MM AC

FERRAMENTAS E UTILIDADES



Multilit

CÓD.	DESCRIÇÃO
3575	PORTA SANFONADA PVC 0,60 BRANCO
3571	PORTA SANFONADA PVC 0,60 BEGE
3567	PORTA SANFONADA PVC 0,60 CINZA
3563	PORTA SANFONADA PVC 0,60 MOGNO
3574	PORTA SANFONADA PVC 0,72 BRANCO
3570	PORTA SANFONADA PVC 0,72 BEGE
3566	PORTA SANFONADA PVC 0,72 CINZA
3562	PORTA SANFONADA PVC 0,72 MOGNO
3573	PORTA SANFONADA PVC 0,84 BRANCO
3569	PORTA SANFONADA PVC 0,84 BEGE
3565	PORTA SANFONADA PVC 0,84 CINZA
3561	PORTA SANFONADA PVC 0,84 MOGNO
3572	PORTA SANFONADA PVC 0,96 BRANCO
3568	PORTA SANFONADA PVC 0,96 BEGE
3564	PORTA SANFONADA PVC 0,96 CINZA
3560	PORTA SANFONADA PVC 0,96 MOGNO



Bestfer

CÓD.	DESCRIÇÃO
7637	TORNO MORSA DE BANCADA 40MM
7638	TORNO MORSA DE BANCADA 50MM
7639	TORNO MORSA DE BANCADA 60MM
7640	TORNO MORSA DE BANCADA 70MM



BOMVINK

CÓD.	DESCRIÇÃO
8570	FONTE DE ALIMENTAÇÃO 21V PARAFUSADEIRA



BOMVINK

CÓD.	DESCRIÇÃO
8583	LANTERNA CHAVEIRO LED C/ ABRIDOR DE GARRAFA



etaniz

CÓD.	DESCRIÇÃO
7301	GÁS PARA MAÇARICO 400ML/215G

ULTRA

/// FERRAMENTAS



FERRAMENTAS E UTILIDADES



CÓD.	DESCRIÇÃO
3933	ABRACADEIRA BRANCA 2,5X100MM
39353937	ABRACADEIRA BRANCA 2,5X150MM
39373939	ABRACADEIRA BRANCA 2,5X200MM
39393941	ABRACADEIRA BRANCA 3,6X150MM
39413943	ABRACADEIRA BRANCA 3,6X180MM
39433945	ABRACADEIRA BRANCA 3,6X200MM
39453947	ABRACADEIRA BRANCA 3,6X250MM
39473949	ABRACADEIRA BRANCA 4,8X180MM
39493950	ABRACADEIRA BRANCA 4,8X200MM
39503952	ABRACADEIRA BRANCA 4,8X250MM
39523954	ABRACADEIRA BRANCA 4,8X300MM
39543956	ABRACADEIRA BRANCA 4,8X400MM
39563958	ABRACADEIRA BRANCA 7,6X200MM
39583959	ABRACADEIRA BRANCA 7,6X250MM
39593961	ABRACADEIRA BRANCA 7,6X300MM
39613963	ABRACADEIRA BRANCA 7,6X400MM
3963	ABRACADEIRA BRANCA 7,9X350MM



CÓD.	DESCRIÇÃO
6284	ABRACADEIRA PRETA 12,7X540MM
62866249	ABRACADEIRA PRETA 12,7X540MM
62496247	ABRACADEIRA PRETA 2,5X100MM
62476253	ABRACADEIRA PRETA 2,5X100MM
62536257	ABRACADEIRA PRETA 2,5X140MM
62576263	ABRACADEIRA PRETA 2,5X140MM
62636258	ABRACADEIRA PRETA 2,5X200MM
62586255	ABRACADEIRA PRETA 2,5X200MM
62556251	ABRACADEIRA PRETA 3,5X140MM
62516265	ABRACADEIRA PRETA 3,5X140MM
62656260	ABRACADEIRA PRETA 3,5X200MM
62606271	ABRACADEIRA PRETA 3,5X200MM
62716269	ABRACADEIRA PRETA 3,5X280MM
62696275	ABRACADEIRA PRETA 3,5X280MM
62756273	ABRACADEIRA PRETA 4,6X300MM
62736278	ABRACADEIRA PRETA 4,6X300MM
62786282	ABRACADEIRA PRETA 4,7X390MM
62826280	ABRACADEIRA PRETA 7,6X400MM
6280	ABRACADEIRA PRETA 7,6X400MM



CÓD.	DESCRIÇÃO
1762	ABRACADEIRA PRETA 2,5 X 100 MM
17631764	ABRACADEIRA PRETA 2,5 X 150 MM
17641765	ABRACADEIRA PRETA 2,5 X 200 MM
17651766	ABRACADEIRA PRETA 3,6 X 150 MM
17661767	ABRACADEIRA PRETA 3,6 X 200 MM
17671768	ABRACADEIRA PRETA 3,6 X 250 MM
17681769	ABRACADEIRA PRETA 3,6 X 300 MM
17691770	ABRACADEIRA PRETA 4,8 X 200 MM
17701771	ABRACADEIRA PRETA 4,8 X 250 MM
17711772	ABRACADEIRA PRETA 4,8 X 300 MM
1772	ABRACADEIRA PRETA 4,8 X 370 MM



CÓD.	DESCRIÇÃO
4922	ABRACADEIRA PRETA 7,6X400MM C/ 50 (UN)
4910	ABRACADEIRA PRETA 2,5X100MM C/ 100 (UN)
4912	ABRACADEIRA PRETA 3,5X150MM C/ 100 (UN)
4918	ABRACADEIRA PRETA 3,5X300MM C/ 100 (UN)
4920	ABRACADEIRA PRETA 4,8X380MM C/ 50 (UN)
4914	ABRACADEIRA PRETA 4,8X200MM C/ 100
4916	ABRACADEIRA PRETA 4,8X280MM C/ 100



CÓD.	DESCRIÇÃO
8363	ABRACADEIRA PRETA 2,5X100 COM 100 UNIDADES
8127	ABRACADEIRA PRETA 3,6X150 COM 100 UNIDADES
8126	ABRACADEIRA PRETA 4,8X200 COM 100 UNIDADES



CÓD.	DESCRIÇÃO
8125	ABRACADEIRA BRANCA 4,8X200 COM 100 PEÇAS
8128	ABRACADEIRA BRANCA 3,6X200 COM 100 PEÇAS
8442	ABRACADEIRA BRANCA 2,5X100 COM 100 PEÇAS
8129	ABRACADEIRA BRANCA 3,6X250 COM 100 PEÇAS



CÓD.	DESCRIÇÃO
3932	ABRACADEIRA PRETA 2,5X100MM
39343936	ABRACADEIRA PRETA 2,5X150MM
39363938	ABRACADEIRA PRETA 2,5X200MM
39383940	ABRACADEIRA PRETA 3,6X150MM
39403942	ABRACADEIRA PRETA 3,6X180MM
39423944	ABRACADEIRA PRETA 3,6X200MM
39443946	ABRACADEIRA PRETA 3,6X250MM
39463948	ABRACADEIRA PRETA 4,8X180MM
39483951	ABRACADEIRA PRETA 4,8X200MM
39513953	ABRACADEIRA PRETA 4,8X300MM
39533955	ABRACADEIRA PRETA 4,8X400MM
39553957	ABRACADEIRA PRETA 7,6X200MM
39573960	ABRACADEIRA PRETA 7,6X250MM
39603962	ABRACADEIRA PRETA 7,6X400MM
3962	ABRACADEIRA PRETA 7,9X350MM



CÓD.	DESCRIÇÃO
6283	ABRACADEIRA BRANCA 12,7X540MM
62856248	ABRACADEIRA BRANCA 12,7X540MM
62486246	ABRACADEIRA BRANCA 2,5X100MM
62466256	ABRACADEIRA BRANCA 2,5X100MM
62566252	ABRACADEIRA BRANCA 2,5X140MM
62526254	ABRACADEIRA BRANCA 2,5X140MM
62546250	ABRACADEIRA BRANCA 3,5X140MM
62506264	ABRACADEIRA BRANCA 3,5X140MM
62646266	ABRACADEIRA BRANCA 3,5X200MM
62666262	ABRACADEIRA BRANCA 4,6X200MM
62626274	ABRACADEIRA BRANCA 4,6X200MM
62746272	ABRACADEIRA BRANCA 4,6X300MM
62726277	ABRACADEIRA BRANCA 4,6X300MM
62776276	ABRACADEIRA BRANCA 4,7X390MM
62766281	ABRACADEIRA BRANCA 4,7X390MM
62816279	ABRACADEIRA BRANCA 7,6X400MM
6279	ABRACADEIRA BRANCA 7,6X400MM



CÓD.	DESCRIÇÃO
4909	ABRACADEIRA BRANCA 2,5X100MM C/ 100 (UN)
4911	ABRACADEIRA BRANCA 3,5X150MM C/ 100 (UN)
4913	ABRACADEIRA BRANCA 4,8X200MM C/ 100 (UN)
4915	ABRACADEIRA BRANCA 4,8X280MM C/ 100 (UN)
4917	ABRACADEIRA BRANCA 3,5X300MM C/ 100 (UN)
4919	ABRACADEIRA BRANCA 4,8X380MM C/ 50 (UN)
4921	ABRACADEIRA BRANCA 7,6X400MM C/ 50 (UN)



CÓD.	DESCRIÇÃO
744	ABRACADEIRA BRANCA 2,5 X 100 MM
745746	ABRACADEIRA BRANCA 2,5 X 150 MM
746747	ABRACADEIRA BRANCA 2,5 X 200 MM
747748	ABRACADEIRA BRANCA 3,6 X 150 MM
748749	ABRACADEIRA BRANCA 3,6 X 200 MM
749750	ABRACADEIRA BRANCA 3,6 X 250 MM
750751	ABRACADEIRA BRANCA 3,6 X 300 MM
751752	ABRACADEIRA BRANCA 4,8 X 200 MM
752753	ABRACADEIRA BRANCA 4,8 X 250 MM
753754	ABRACADEIRA BRANCA 4,8 X 300 MM
754	ABRACADEIRA BRANCA 4,8 X 370 MM